

# Bridgelux® V22 F90 Array Series

Product Data Sheet DS449-3



# Introduction

V Series

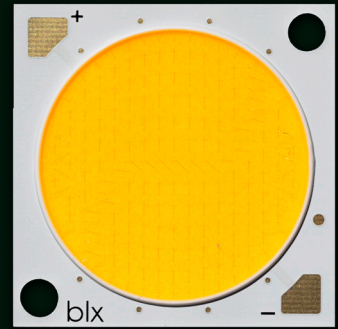

The V Series™ LED Array products deliver high quality light in a compact and cost-effective solid-state lighting package. These chip on board (CoB) arrays can be efficiently driven up to two times the nominal drive current, enabling design flexibility not previously possible. These high flux density light sources are designed to support a wide range of high quality, low cost directional luminaires and replacement lamps for both interior and exterior commercial and residential applications.

The F90 V Series COB is a high efficacy product that uses narrow band red phosphor to significantly improve the spectrum efficacy. The improved spectrum efficacy results in the 90 CRI product of the F90 Series delivering better or equivalent efficacy as that of our traditional 80 CRI V Series product.

The V22 LED Array is available in a variety of electrical, CCT, and CRI combinations providing substantial design flexibility and energy efficiency advantages.

Lighting system designs incorporating these LED arrays deliver increased system level efficacy and a longer service life. Typical applications include replacement lamps and task, accent, spot, track, wide area, security, wall packs and down lights.

## Features

- Efficacy of 180 lm/W typical, 3000K 90 CRI
- Wide selection of CCT options (2700K-4000K) with minimum 90 CRI options
- Uniform high-quality illumination
- 2 and 3 SDCM binning options (2700K – 4000K)
- Forward voltage bin codes and backside marking
- Instant light with unlimited dimming
- 5-Year warranty

## Benefits

- Enables high efficiency lighting systems and lower operating costs
- Supports the trend toward luminaire miniaturization and delivers enhanced optical control
- Design flexibility for a broad range of lighting applications
- Clean white light without pixelation
- Uniform consistent white light
- Design flexibility for multi-source applications
- Easy to use with daylight and motion sensors to increase energy savings
- Design with confidence



# Contents

Product Feature Map	2
Product Nomenclature	2
Product Selection Guide	3
European Product Registry for Energy Labeling	5
Performance at Commonly Used Drive Currents	6
Electrical Characteristics	8
Eye Safety	9
Absolute Maximum Ratings	10
Performance Curves	11
Typical Radiation Pattern	13
Typical Color Spectrum	14
Mechanical Dimensions	15
Color Binning Information	16
Packaging and Labeling	17
Design Resources	19
Precautions	19
Disclaimers	19
About Bridgelux	20

# Product Feature Map

Bridgelux arrays are fully engineered devices that provide consistent thermal and optical performance on an engineered mechanical platform. The V Series arrays are the most compact CoB devices across all of Bridgelux's LED Array products.

The arrays incorporate several features to simplify design integration and assembly. Please visit [www.bridgelux.com](http://www.bridgelux.com) for more information on the V Series family of products.

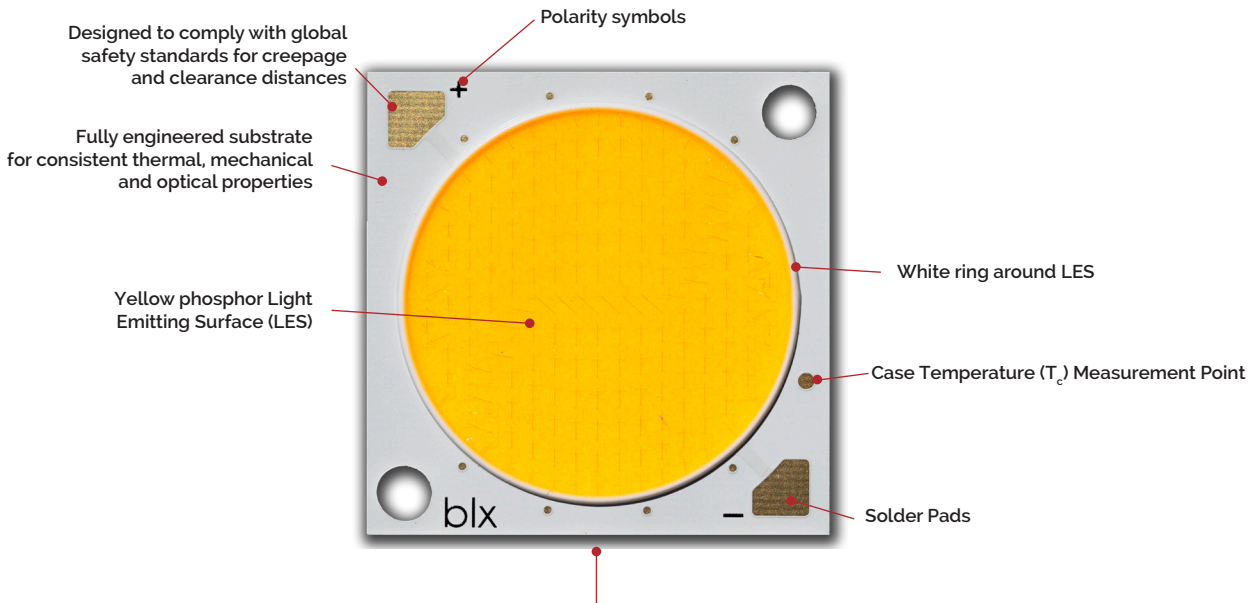

Note: Part number and lot codes are scribed on back of array

## Product Nomenclature

The part number designation for Bridgelux V Series LED arrays is explained as follows:

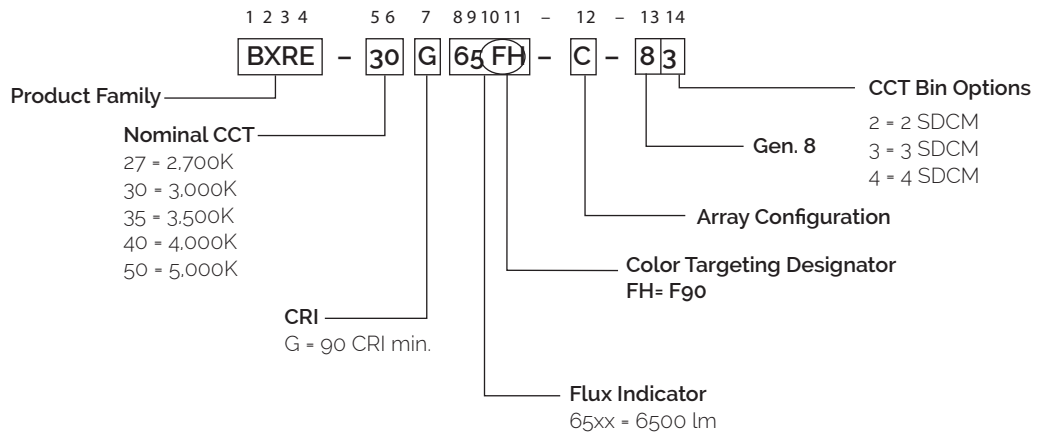

# Product Selection Guide

The following product configurations are available:

**Table 1:** Selection Guide, Pulsed Measurement Data ( $T_j = T_c = 25^\circ\text{C}$ )

Part Number	Nominal CCT <sup>1</sup> (K)	CRI <sup>2</sup>	Nominal Drive Current <sup>3</sup> (mA)	Typical Pulsed Flux <sup>4,5,6</sup> $T_c = 25^\circ\text{C}$ (lm)	Minimum Pulsed Flux <sup>6,7</sup> $T_c = 25^\circ\text{C}$ (lm)	Typical $V_f$ (V)	Typical Power (W)	Typical Efficacy (lm/W)
BXRE-27G65FH-B-8x	2700	90	950	8669	7802	51.6	49.0	177
BXRE-27G65FH-C-8x	2700	90	1200	10916	9824	52.0	62.4	175
BXRE-27G65FH-D-8x	2700	90	1050	6401	5761	34.5	36.2	177
BXRE-30G65FH-B-8x	3000	90	950	8846	7961	51.6	49.0	180
BXRE-30G65FH-C-8x	3000	90	1200	11139	10025	52.0	62.4	179
BXRE-30G65FH-D-8x	3000	90	1050	6532	5879	34.5	36.2	180
BXRE-35G65FH-B-8x	3500	90	950	8795	7916	51.6	49.0	179
BXRE-35G65FH-C-8x	3500	90	1200	11075	9968	52.0	62.4	178
BXRE-35G65FH-D-8x	3500	90	1050	6495	5845	34.5	36.2	179
BXRE-40G65FH-B-8x	4000	90	950	8882	7994	51.6	49.0	181
BXRE-40G65FH-C-8x	4000	90	1200	11185	10066	52.0	62.4	179
BXRE-40G65FH-D-8x	4000	90	1050	6559	5903	34.5	36.2	181

Notes for Table 1:

1. Nominal CCT as defined by ANSI C78.377-2011.
2. CRI values are minimums and tested at  $T_j = T_c = 25^\circ\text{C}$ . Minimum Rg value for 90 CRI products is 50. Bridgelux maintains a  $\pm 3$  tolerance on CRI and Rg values.
3. Drive current is referred to as nominal drive current.
4. Products tested under pulsed condition (10ms pulse width) at nominal test current where  $T_j$  (junction temperature) -  $T_c$  (case temperature) -  $25^\circ\text{C}$ .
5. Typical performance values are provided as a reference only and are not a guarantee of performance.
6. Bridgelux maintains a  $\pm 7\%$  tolerance on flux measurements.
7. Minimum flux values at the nominal test current are guaranteed by 100% test.

# Product Selection Guide

**Table 2:** Selection Guide, Stabilized DC Performance ( $T_c = 65^\circ\text{C}$ )<sup>4,5</sup>

Part Number	Nominal CCT <sup>1</sup> (K)	CRI <sup>2</sup>	Nominal Drive Current <sup>3</sup> (mA)	Typical DC Flux <sup>4,5</sup> $T_c = 65^\circ\text{C}$ (lm)	Minimum DC Flux <sup>6</sup> $T_c = 65^\circ\text{C}$ (lm)	Typical $V_f$ (V)	Typical Power (W)	Typical Efficacy (lm/W)
BXRE-27G65FH-B-8x	2700	90	950	8105	7295	50.9	48.4	168
BXRE-27G65FH-C-8x	2700	90	1200	10206	9186	51.3	61.6	166
BXRE-27G65FH-D-8x	2700	90	1050	5985	5387	34.0	35.7	168
BXRE-30G65FH-B-8x	3000	90	950	8271	7444	50.9	48.4	171
BXRE-30G65FH-C-8x	3000	90	1200	10415	9373	51.3	61.6	169
BXRE-30G65FH-D-8x	3000	90	1050	6107	5497	34.0	35.7	171
BXRE-35G65FH-B-8x	3500	90	950	8224	7401	50.9	48.4	170
BXRE-35G65FH-C-8x	3500	90	1200	10355	9320	51.3	61.6	168
BXRE-35G65FH-D-8x	3500	90	1050	6072	5465	34.0	35.7	170
BXRE-40G65FH-B-8x	4000	90	950	8305	7474	50.9	48.4	172
BXRE-40G65FH-C-8x	4000	90	1200	10458	9412	51.3	61.6	170
BXRE-40G65FH-D-8x	4000	90	1050	6133	5519	34.0	35.7	172

Notes for Table 2:

1. Nominal CCT as defined by ANSI C78.377-2011.
2. CRI values are minimums and tested at  $T_j = T_c = 65^\circ\text{C}$ . Minimum Rg value for 90 CRI products is 50.
3. Drive current is referred to as nominal drive current.
4. Typical stabilized DC performance values are provided as reference only and are not a guarantee of performance.
5. Typical performance is estimated based on operation under DC (direct current) with LED array mounted onto a heat sink with thermal interface material and the case temperature maintained at  $65^\circ\text{C}$ . Based on Bridgelux test setup, values may vary depending on the thermal design of the luminaire and/or the exposed environment to which the product is subjected.
6. Minimum flux values at elevated temperatures are provided for reference only and are not guaranteed by 100% production testing. Based on Bridgelux test setup, values may vary depending on the thermal design of the luminaire and/or the exposed environment to which the product is subjected.

# European Product Registry for Energy Labeling

The European Product Registry for Energy Labeling (EPREL) is defined in the EU Regulation 2017/1369 to provide important energy efficiency information to consumers. Together with Energy Labeling Regulation ELR (EU) 2019/2015 which was amended by regulation (EU) 2021/340 for energy labelling of light sources, manufacturers are required to declare an energy class based on key technical specifications from each of their product and register it in an open data base managed by EPREL. It is now a legal requirement for a vendor of light sources to upload information about their products into the EPREL database before placing these products on the market in the EU.

Table 3 below provides a list of part numbers that are in compliance with ELR and are currently listed in the EPREL database.

At Bridgelux, we are fully committed to supplying products that are compliant with pertinent laws, rules, and obligation imposed by relevant government bodies including the European Energy Labeling regulation. Customers can use these products with full confidence for any projects that fall under the ELR.

**Table 3:** Part numbers registered in European Product Registry for Energy Labeling

PART NUMBER <sup>1</sup>	CCT (K)	CRI	Current <sup>2</sup> (mA)	Vf (V)	Useful flux <sup>3</sup> ( $\Phi_{use}$ ) at 85C (lm)	Power (W)	Efficacy (lm/W)	Energy efficiency class <sup>4</sup> 	Registration No	URL to Product Information Sheet in EPREL Database
BXRE-27G65FH-B-83	2700	90	2340	57.0	17352	133	130	E	1441961	<a href="https://eprelec.europa.eu/qr/1441961">https://eprelec.europa.eu/qr/1441961</a>
BXRE-27G65FH-C-83	2700	90	2700	57.0	20109	154	131	E	1441962	<a href="https://eprelec.europa.eu/qr/1441962">https://eprelec.europa.eu/qr/1441962</a>
BXRE-27G65FH-D-83	2700	90	2520	38.0	12511	96	131	E	1441963	<a href="https://eprelec.europa.eu/qr/1441963">https://eprelec.europa.eu/qr/1441963</a>
BXRE-30G65FH-B-83	3000	90	2340	57.0	17706	133	133	E	1441978	<a href="https://eprelec.europa.eu/qr/1441978">https://eprelec.europa.eu/qr/1441978</a>
BXRE-30G65FH-C-83	3000	90	2700	57.0	20519	154	133	E	1441979	<a href="https://eprelec.europa.eu/qr/1441979">https://eprelec.europa.eu/qr/1441979</a>
BXRE-30G65FH-D-83	3000	90	2520	38.0	12766	96	133	E	1441980	<a href="https://eprelec.europa.eu/qr/1441980">https://eprelec.europa.eu/qr/1441980</a>
BXRE-35G65FH-B-83	3500	90	2340	57.0	17610	133	132	E	1441995	<a href="https://eprelec.europa.eu/qr/1441995">https://eprelec.europa.eu/qr/1441995</a>
BXRE-35G65FH-C-83	3500	90	2700	57.0	20407	154	133	E	1441996	<a href="https://eprelec.europa.eu/qr/1441996">https://eprelec.europa.eu/qr/1441996</a>
BXRE-35G65FH-D-83	3500	90	2520	38.0	12696	96	133	E	1441997	<a href="https://eprelec.europa.eu/qr/1441997">https://eprelec.europa.eu/qr/1441997</a>
BXRE-40G65FH-B-83	4000	90	2340	57.0	17784	133	133	E	1442013	<a href="https://eprelec.europa.eu/qr/1442013">https://eprelec.europa.eu/qr/1442013</a>
BXRE-40G65FH-C-83	4000	90	2700	57.0	20609	154	134	E	1442014	<a href="https://eprelec.europa.eu/qr/1442014">https://eprelec.europa.eu/qr/1442014</a>
BXRE-40G65FH-D-83	4000	90	2520	38.0	12822	96	134	E	1442015	<a href="https://eprelec.europa.eu/qr/1442015">https://eprelec.europa.eu/qr/1442015</a>

Notes for Table 3:

1. All device listed here must be disposed as e-waste upon its end of life according to local country guideline in each country.
2. For information on performance values at alternative drive conditions, please refer to the Product Selection Guide, Absolute Maximum Rating Table and Performance Curves in this data sheet.
3. For a definition of useful luminous flux ( $\Phi_{use}$ ), please see the ELR regulations at <https://tinyurl.com/4b6zvt4m>.
4. EPREL requires an arrow symbol containing the letter of the energy efficiency class to be displayed, on technical promotional material. Refer to this energy efficiency class column for specific energy efficiency class on each part number.

# Performance at Commonly Used Drive Currents

V Series LED arrays are tested to the specifications shown using the nominal drive currents in Table 1. V Series may also be driven at other drive currents dependent on specific application design requirements. The performance at any drive current can be derived from the current vs. voltage characteristics shown in Figures 1, 2 & 3 and the flux vs. current characteristics shown in Figures 4, 5 & 6. The performance at commonly used drive currents is summarized in Table 4.

**Table 4:** Product Performance at Commonly Used Drive Currents

Part Number	CRI	Drive Current <sup>1</sup> (mA)	Typical V <sub>f</sub> T <sub>c</sub> = 25°C (V)	Typical Power T <sub>c</sub> = 25°C (W)	Typical Flux <sup>2</sup> T <sub>c</sub> = 25°C (lm)	Typical DC Flux <sup>3</sup> T <sub>c</sub> = 65°C (lm)	Typical Efficacy T <sub>c</sub> = 25°C (lm/W)
BXRE-27G65FH-B-8x	90	475	49.4	23.4	4462	4215	190
		725	50.6	36.7	6702	6304	183
		<b>950</b>	<b>51.6</b>	<b>49.0</b>	<b>8669</b>	<b>8105</b>	<b>177</b>
		1170	52.6	61.5	10548	9797	171
		1900	55.6	105.6	16471	14978	156
		2340	57.2	133.8	19302	17345	144
BXRE-27G65FH-C-8x	90	600	49.6	29.7	5629	5329	189
		900	50.8	45.7	8308	7825	182
		<b>1200</b>	<b>52.0</b>	<b>62.4</b>	<b>10916</b>	<b>10206</b>	<b>175</b>
		1440	52.9	76.2	12951	12033	170
		2400	56.2	134.9	20643	18736	153
		2700	57.2	154.3	22899	20616	148
BXRE-27G65FH-D-8x	90	525	32.9	17.3	3292	3125	190
		785	33.7	26.5	4847	4589	183
		<b>1050</b>	<b>34.5</b>	<b>36.2</b>	<b>6401</b>	<b>5985</b>	<b>177</b>
		1400	35.4	49.6	8374	7713	169
		2100	37.2	78.1	12131	10987	155
		2520	38.1	96.0	14253	12807	148
BXRE-30G65FH-B-8x	90	475	49.4	23.4	4553	4301	194
		725	50.6	36.7	6838	6433	187
		<b>950</b>	<b>51.6</b>	<b>49.0</b>	<b>8846</b>	<b>8271</b>	<b>180</b>
		1170	52.6	61.5	10763	9998	175
		1900	55.6	105.6	16807	15285	159
		2340	57.2	133.8	19696	17700	147
BXRE-30G65FH-C-8x	90	600	49.6	29.7	5744	5438	193
		900	50.8	45.7	8477	7985	185
		<b>1200</b>	<b>52.0</b>	<b>62.4</b>	<b>11139</b>	<b>10415</b>	<b>179</b>
		1440	52.9	76.2	13216	12280	173
		2400	56.2	134.9	21064	19119	156
		2700	57.2	154.3	23366	21038	151
BXRE-30G65FH-D-8x	90	525	32.9	17.3	3360	3189	194
		785	33.7	26.5	4946	4682	187
		<b>1050</b>	<b>34.5</b>	<b>36.2</b>	<b>6532</b>	<b>6107</b>	<b>180</b>
		1400	35.4	49.6	8545	7871	172
		2100	37.2	78.1	12378	11211	159
		2520	38.1	96.0	14544	13068	151

Notes for Table 4:

1. Alternate drive currents in Table 4 are provided for reference only and are not a guarantee of performance.
2. Bridgelux maintains a ± 7% tolerance on flux measurements.
3. Typical stabilized DC performance values are provided as reference only and are not a guarantee of performance.



# Performance at Commonly Used Drive Currents

**Table 4:** Product Performance at Commonly Used Drive Currents (Continued)

Part Number	CRI	Drive Current <sup>1</sup> (mA)	Typical V <sub>f</sub> T <sub>c</sub> = 25°C (V)	Typical Power T <sub>c</sub> = 25°C (W)	Typical Flux <sup>2</sup> T <sub>c</sub> = 25°C (lm)	Typical DC Flux <sup>3</sup> T <sub>c</sub> = 65°C (lm)	Typical Efficacy T <sub>c</sub> = 25°C (lm/W)
BXRE-35G65FH-B-8x	90	475	49.4	23.4	4528	4276	193
		725	50.6	36.7	6799	6396	186
		<b>950</b>	<b>51.6</b>	<b>49.0</b>	<b>8795</b>	<b>8224</b>	<b>179</b>
		1170	52.6	61.5	10702	9941	174
		1900	55.6	105.6	16711	15198	158
		2340	57.2	133.8	19584	17599	146
BXRE-35G65FH-C-8x	90	600	49.6	29.7	5711	5407	192
		900	50.8	45.7	8429	7939	184
		<b>1200</b>	<b>52.0</b>	<b>62.4</b>	<b>11075</b>	<b>10355</b>	<b>178</b>
		1440	52.9	76.2	13140	12209	172
		2400	56.2	134.9	20944	19009	155
		2700	57.2	154.3	23233	20917	151
BXRE-35G65FH-D-8x	90	525	32.9	17.3	3340	3171	193
		785	33.7	26.5	4918	4655	186
		<b>1050</b>	<b>34.5</b>	<b>36.2</b>	<b>6495</b>	<b>6072</b>	<b>179</b>
		1400	35.4	49.6	8496	7826	171
		2100	37.2	78.1	12308	11147	158
		2520	38.1	96.0	14461	12994	151
BXRE-40G65FH-B-8x	90	475	49.4	23.4	4572	4319	195
		725	50.6	36.7	6867	6459	187
		<b>950</b>	<b>51.6</b>	<b>49.0</b>	<b>8882</b>	<b>8305</b>	<b>181</b>
		1170	52.6	61.5	10808	10039	176
		1900	55.6	105.6	16877	15348	160
		2340	57.2	133.8	19778	17773	148
BXRE-40G65FH-C-8x	90	600	49.6	29.7	5768	5461	194
		900	50.8	45.7	8512	8018	186
		<b>1200</b>	<b>52.0</b>	<b>62.4</b>	<b>11185</b>	<b>10458</b>	<b>179</b>
		1440	52.9	76.2	13271	12331	174
		2400	56.2	134.9	21152	19198	157
		2700	57.2	154.3	23463	21125	152
BXRE-40G65FH-D-8x	90	525	32.9	17.3	3374	3202	195
		785	33.7	26.5	4967	4702	188
		<b>1050</b>	<b>34.5</b>	<b>36.2</b>	<b>6559</b>	<b>6133</b>	<b>181</b>
		1400	35.4	49.6	8580	7904	173
		2100	37.2	78.1	12430	11259	159
		2520	38.1	96.0	14604	13124	152

Notes for Table 4:

1. Alternate drive currents in Table 4 are provided for reference only and are not a guarantee of performance.
2. Bridgelux maintains a ± 7% tolerance on flux measurements.
3. Typical stabilized DC performance values are provided as reference only and are not a guarantee of performance.

# Electrical Characteristics

**Table 5:** Electrical Characteristics

Part Number	Drive Current (mA)	Forward Voltage Pulsed, $T_c = 25^\circ\text{C}$ (V) <sup>1, 2, 3, 8</sup>			Typical Coefficient of Forward Voltage <sup>4</sup> $\Delta V_f / \Delta T_c$ (mV/ $^\circ\text{C}$ )	Typical Thermal Resistance Junction to Case <sup>5,6</sup> $R_{j-c}$ ( $^\circ\text{C}/\text{W}$ )	Driver Selection Voltages <sup>7</sup> (V)	
		Minimum	Typical	Maximum			$V_f$ Min. Hot $T_c = 95^\circ\text{C}$ (V)	$V_f$ Max. Cold $T_c = -40^\circ\text{C}$ (V)
BXRE-xxx65Fx-B-8x	950	48.5	51.6	54.7	-17	0.07	47.3	55.8
	2340	53.7	57.2	60.6	-19	0.13	52.4	61.8
BXRE-xxx65Fx-C-8x	1200	48.9	52.0	55.1	-17	0.08	47.7	56.2
	2700	53.7	57.2	60.6	-19	0.15	52.4	61.8
BXRE-xxx65Fx-D-8x	1050	32.4	34.5	36.5	-11	0.08	31.6	37.3
	2520	35.8	38.1	40.4	-13	0.14	34.9	41.2

Notes for Table 5:

- Parts are tested in pulsed conditions.  $T_c = 25^\circ\text{C}$ . Pulse width is 10ms.
- Voltage minimum and maximum are provided for reference only and are not a guarantee of performance.
- Bridgelux maintains a tester tolerance of  $\pm 0.10\text{V}$  on forward voltage measurements.
- Typical coefficient of forward voltage tolerance is  $\pm 0.1\text{mV}$  for nominal current.
- Thermal resistance values are based from test data of a 3000K 90 CRI product.
- Thermal resistance value was calculated using total electrical input power; optical power was not subtracted from input power. The thermal interface material used during testing is not included in the thermal resistance value.
- $V_f$  min hot and max cold values are provided as reference only and are not guaranteed by test. These values are provided to aid in driver design and selection over the operating range of the product.
- This product has been designed and manufactured per IEC 62031:2018. This product has passed dielectric withstand voltage testing at 1140 V. The working voltage designated for the insulation is 70V d.c. The maximum allowable voltage across the array must be determined in the end product application.

# Eye Safety

**Table 6:** Eye Safety Risk Group (RG) Classifications

Part Number	Drive Current (mA)	CCT <sup>4</sup>	
		2700K/3000K	3500-5000K <sup>2,3</sup>
BXRE-xxx65Fx-B-8x	1485	RG1	RG1
	2340	RG1	RG2
BXRE-xxx65Fx-C-8x	1515	RG1	RG1
	2500	RG1	RG2
	2700	RG2	RG2
BXRE-xxx65Fx-D-8x	2160	RG1	RG1
	2520	RG1	RG2

Notes for Table 6:

1. Eye safety classification for the use of Bridgelux V Series LED arrays is in accordance with specification IEC/TR 62778: Application of IEC 62471 for the assessment of blue light hazard to light sources and luminaires.
2. For products classified as RG2 at 4000K, Ethr= 1980 lx.
3. For products classified as RG2 at 5000K Ethr= 1530 lx.
4. Please contact your Bridgelux sales representative for Ethr values at specific drive currents and CCTs not listed.

# Absolute Maximum Ratings

**Table 7:** Maximum Ratings

Parameter	Maximum Rating		
LED Junction Temperature ( $T_j$ )	150°C		
Storage Temperature <sup>1</sup>	-40°C to +95°C		
Operating Case Temperature <sup>2</sup> ( $T_c$ )	95°C		
Soldering Temperature <sup>3</sup>	300°C or lower for a maximum of 6 seconds		
	BXRE-xxx65Fx-B-8x	BXRE-xxx65Fx-C-8x	BXRE-xxx65Fx-D-8x
Maximum Drive Current <sup>4</sup>	2340 mA at $\leq 85^\circ\text{C}$ 1755 mA at 95°C	2700 mA at $\leq 85^\circ\text{C}$ 2025 mA at 95°C	2520 mA at $\leq 85^\circ\text{C}$ 1890 mA at 95°C
Maximum Peak Pulsed Drive Current <sup>5</sup>	3350 mA	3870 mA	3610 mA
Maximum Reverse Voltage <sup>6</sup>	-90V	-90V	-50V

Notes for Table 7:

1. The Fg0 product is robust enough to pass our internal humidity test but it is still more sensitive compared to regular LED array product. The product needs to be stored in a dry environment. It is not recommended to use the product in a damp environment that directly exposes it to moisture.
2. For IEC 62717 requirement, please consult your Bridgelux sales representative.
3. Refer to Bridgelux Application Note AN101: Handling and Assembly of Bridgelux V Series LED Arrays
4. Arrays may be driven at higher currents however lumen maintenance may be reduced and warranty will not apply.
5. Bridgelux recommends a maximum duty cycle of 10% and pulse width of 20 ms when operating LED Arrays at maximum peak pulsed current specified. Maximum peak pulsed currents indicate values where LED Arrays can be driven without catastrophic failures.
6. Light emitting diodes are not designed to be driven in reverse voltage and will not produce light under this condition. Maximum rating provided for reference only.

# Performance Curves

**Figure 1: V22B Drive Current vs. Voltage**

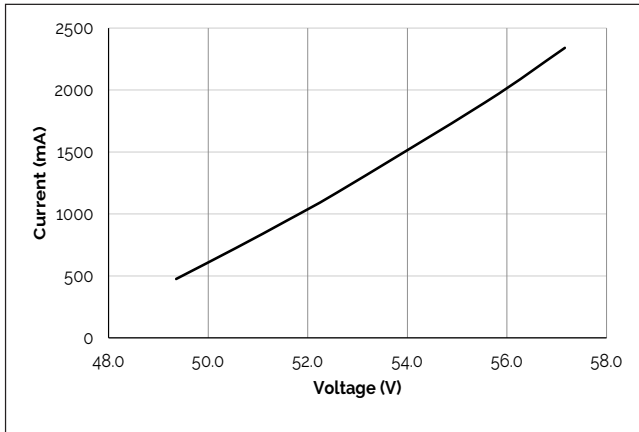

**Figure 2: V22C Drive Current vs. Voltage**

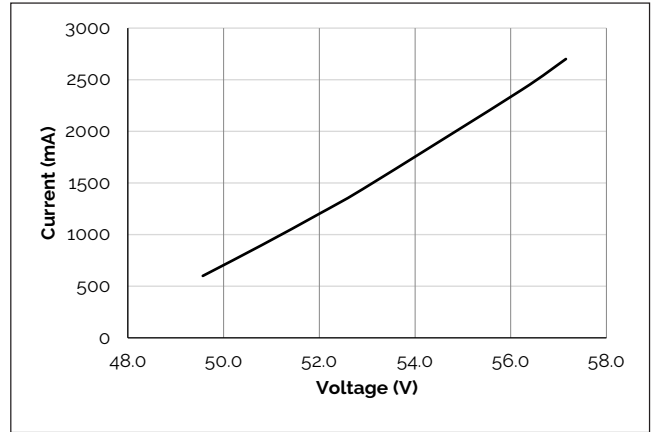

**Figure 3: V22D Drive Current vs. Voltage**

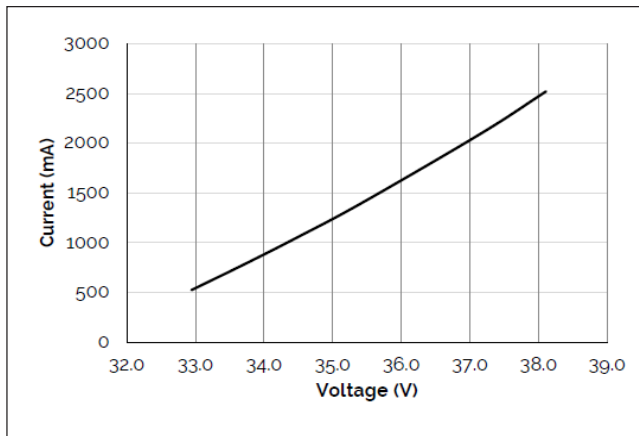

**Figure 4: V22B Typical Relative Flux vs. Current**

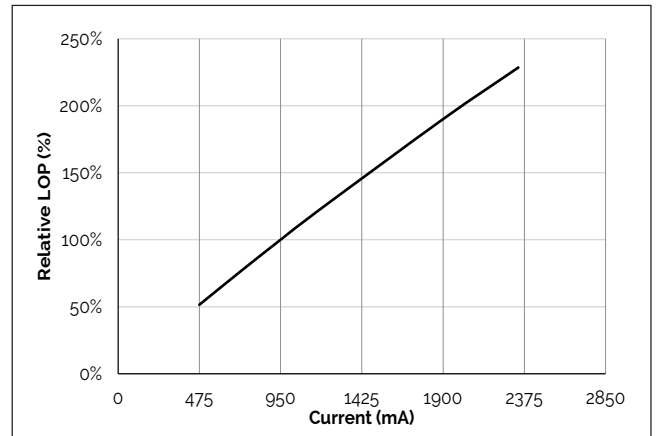

**Figure 5: V22C Typical Relative Flux vs. Current**

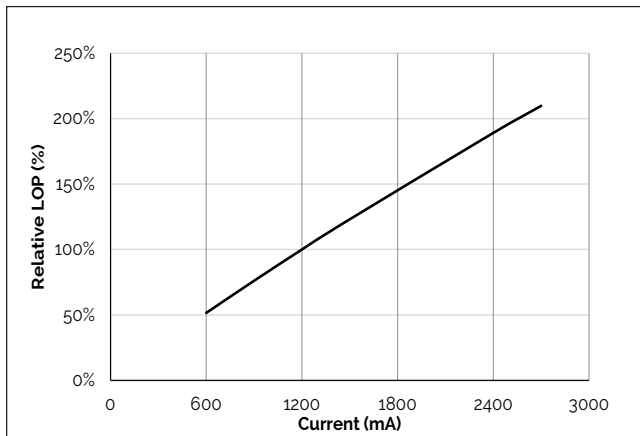

**Figure 6: V22D Typical Relative Flux vs. Current**

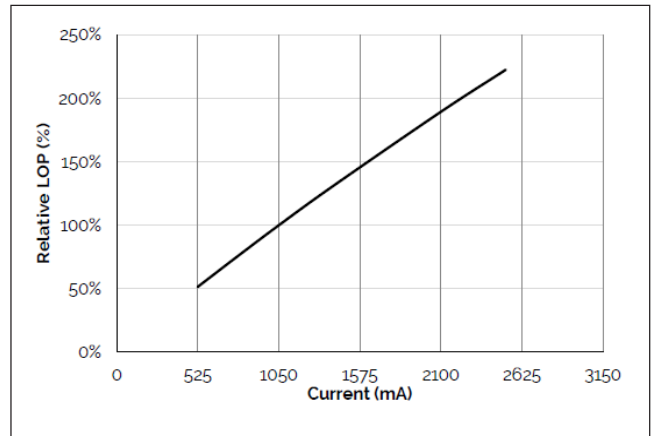

Notes for Figures 1-6:

1. Bridgelux does not recommend driving high power LEDs at low currents. Doing so may produce unpredictable results. Pulse width modulation (PWM) is recommended for dimming effects.
2. Products tested under pulsed condition (10ms pulse width) at nominal test current where  $T_j$  (junction temperature) -  $T_c$  (case temperature) = 25°C.

# Performance Curves

**Figure 7: Typical DC Flux vs. Case Temperature**

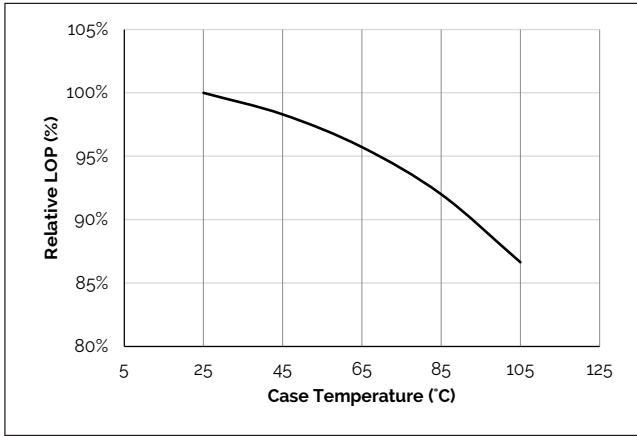

**Figure 8: Derating Curve**

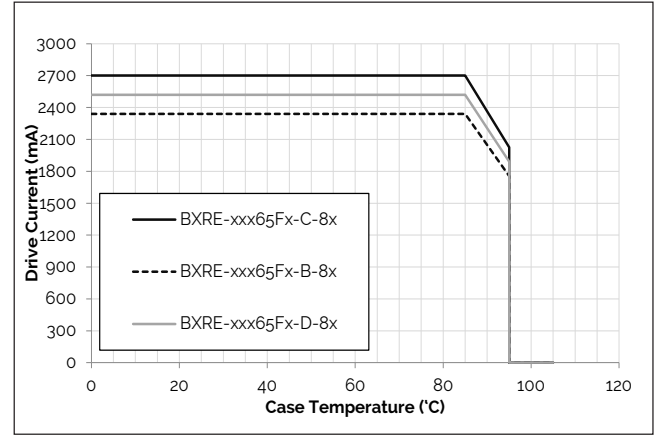

Notes for Figures 7-8:

1. Bridgelux does not recommend driving high power LEDs at low currents. Doing so may produce unpredictable results. Pulse width modulation (PWM) is recommended for dimming effects.
2. Products tested under pulsed condition (10ms pulse width) at nominal test current where  $T_j$  (junction temperature) -  $T_c$  (case temperature) = 25°C.

# Typical Radiation Pattern

Figure 9: Typical Spatial Radiation Pattern

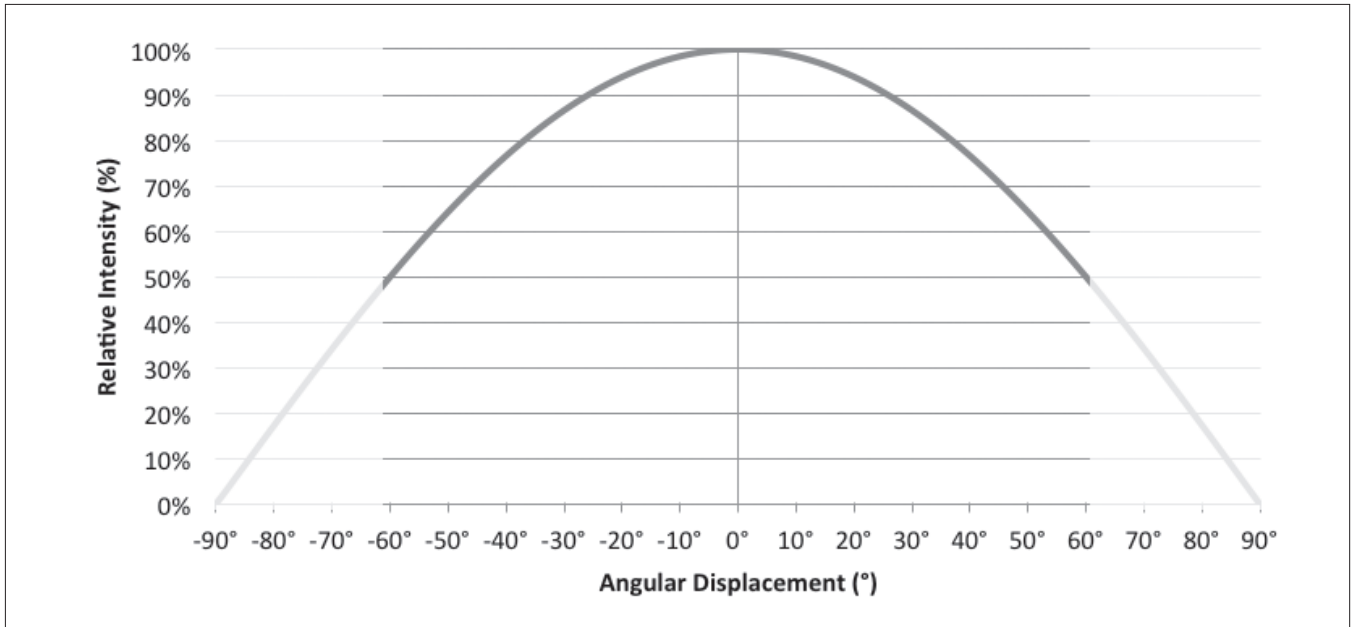

Notes for Figure 9:

1. Typical viewing angle is 120°.
2. The viewing angle is defined as the off axis angle from the centerline where intensity is ½ of the peak value.

Figure 10: Typical Polar Radiation Pattern

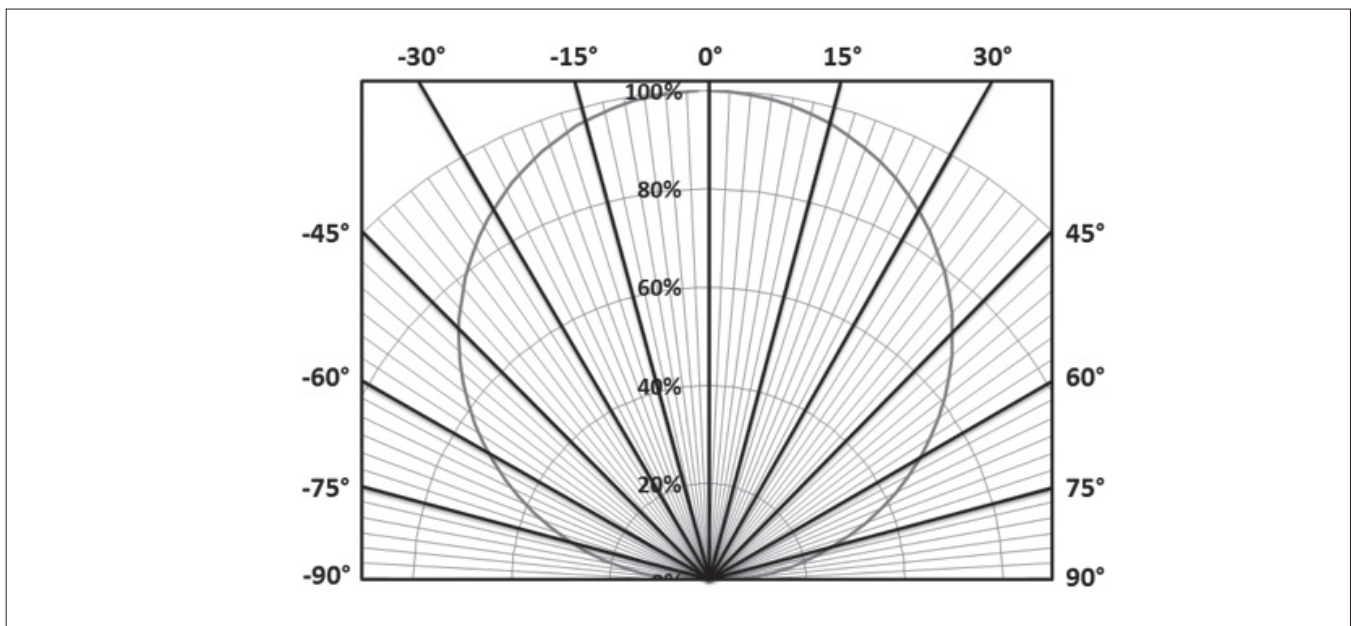

# Typical Color Spectrum

Figure 11: Typical Color Spectrum

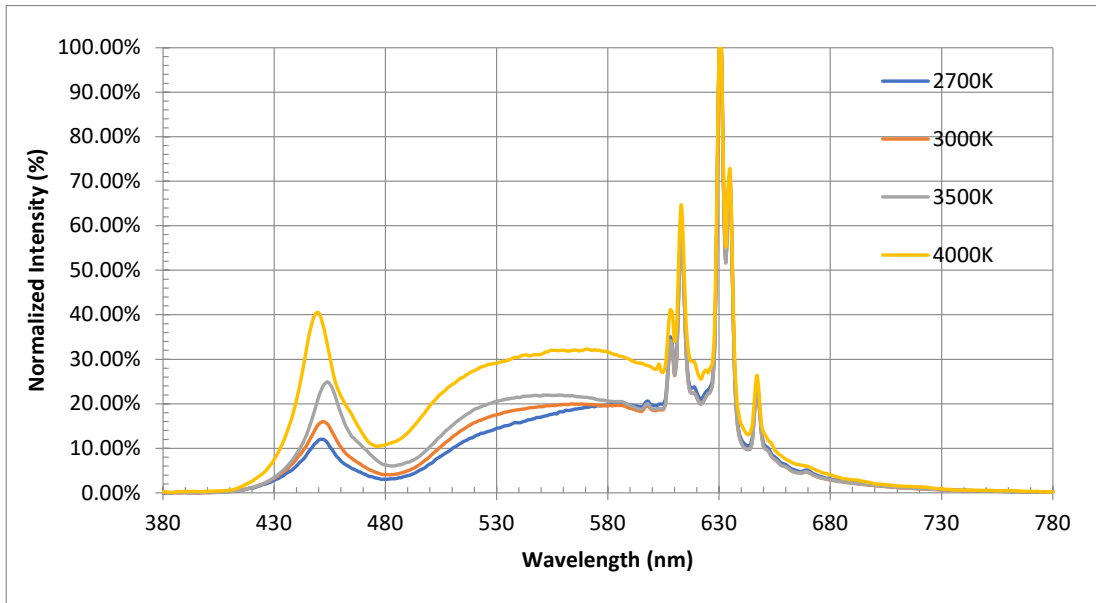

Notes for Figure 11:

1. Color spectra measured at nominal current for  $T_j = T_c = 65^\circ\text{C}$ .
2. Color spectra shown is 2700K and 90CRI.
3. Color spectra shown is 3000K and 90 CRI.
4. Color spectra shown is 3500K and 90 CRI.
5. Color spectra shown is 4000K and 90 CRI.



# Mechanical Dimensions

**Figure 12: Drawing for V22 LED Array**

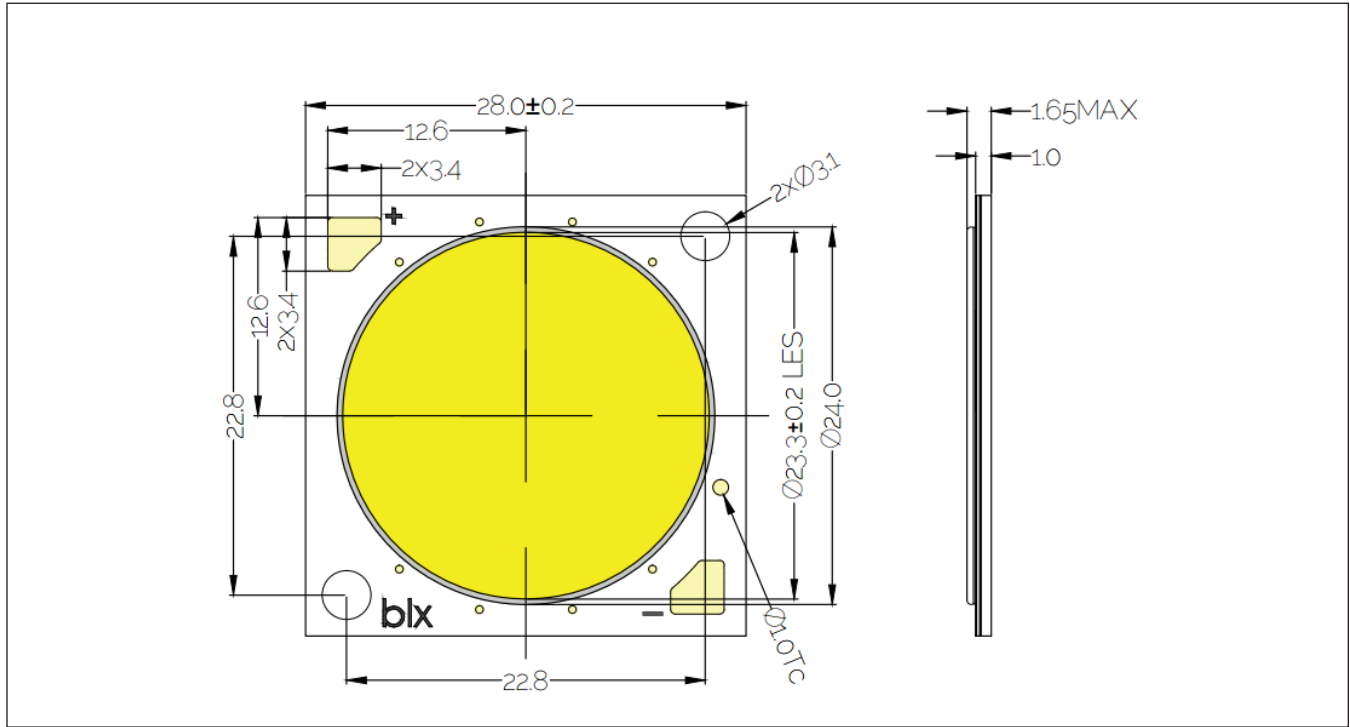

Notes for Figure 12:

1. Drawings are not to scale.
2. Drawing dimensions are in millimeters.
3. Unless otherwise specified, tolerances are ±0.1mm.
4. Solder pad labeled "+" denotes positive contact.
5. Refer to Application Notes AN101 for product handling, mounting and heat sink recommendations.
6. The optical center of the LED Array is nominally defined by the mechanical center of the array to a tolerance of ± 0.2mm.
7. Bridgelux maintains a flatness of 0.10mm across the mounting surface of the array.

# Color Binning Information

**Figure 13: Warm and Neutral White Test Bins in xy Color Space**

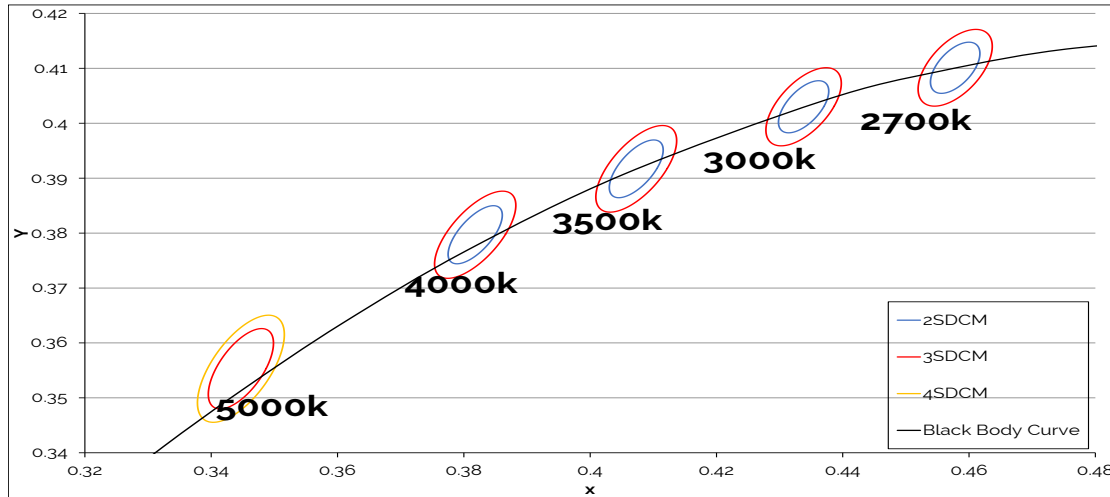

Note: Pulsed Test Conditions,  $T_c = 65^\circ\text{C}$

**Table 8: Warm and Neutral White xy Bin Coordinates and Associated Typical CCT (product is hot targeted to  $T_c = 65^\circ\text{C}$ )**

Bin Code	2700K	3000K	3500K	4000K
ANSI Bin (for reference only)	(2580K - 2870K)	(2870K - 3220K)	(3220K - 3710K)	(3710K - 4260K)
83 (3 SDCM)	(2651K - 2794K)	(2968K - 3136K)	(3369K - 3586K)	(3851K - 4130K)
82 (2 SDCM)	(2674K - 2769K)	(2995K - 3107K)	(3404K - 3548K)	(3895K - 4081K)
Center Point (x,y)	(0.4578, 0.4101)	(0.4338, 0.403)	(0.4073, 0.3917)	(0.3818, 0.3797)

Note for Tables 8:

1. Bridgelux maintains a tolerance of +/- 0.007 on x and y color coordinates in the CIE 1931 color Space.

# Packaging and Labeling

Figure 14: Drawing for V22 Packaging Tube

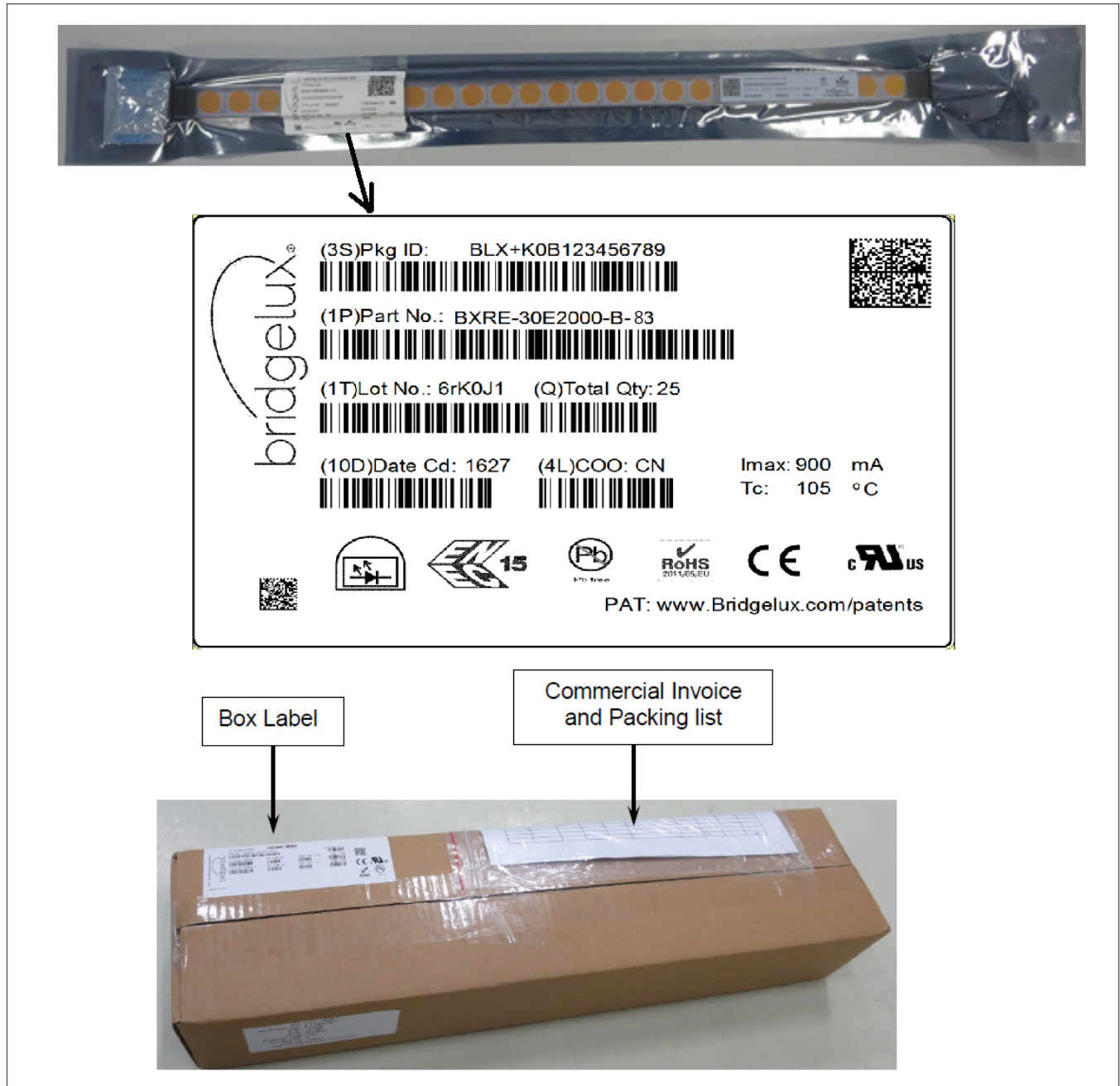

Notes for Figure 14

1. Each tube holds 15 V22 COB arrays.
2. Four tubes are sealed in an anti-static bag. Four bags are placed in a shipping box and shipped. Depending on quantities ordered, a bigger shipping box, containing four boxes may be used to ship products.
3. Each bag and box is to be labeled as shown above.
4. Dimensions for each tube are 30.7 (W) x 9.65(H) x 460(L). Dimensions for the anti-static bag are 120mm (W) x 635mm (L) x 0.1 (T) mm. Dimensions for the shipping box are 58.7 x 13.3 x 7.9 cm.

# Packaging and Labeling

**Figure 15: Gen. 8 Product Labeling**

Bridgelux COB arrays have laser markings on the back side of the substrate to help with product identification. In addition to the product identification markings, Bridgelux COB arrays also contain markings for internal Bridgelux manufacturing use only. The image below shows which markings are for customer use and which ones are for Bridgelux internal use only. The Bridgelux internal manufacturing markings are subject to change without notice, however these will not impact the form, function or performance of the COB array.

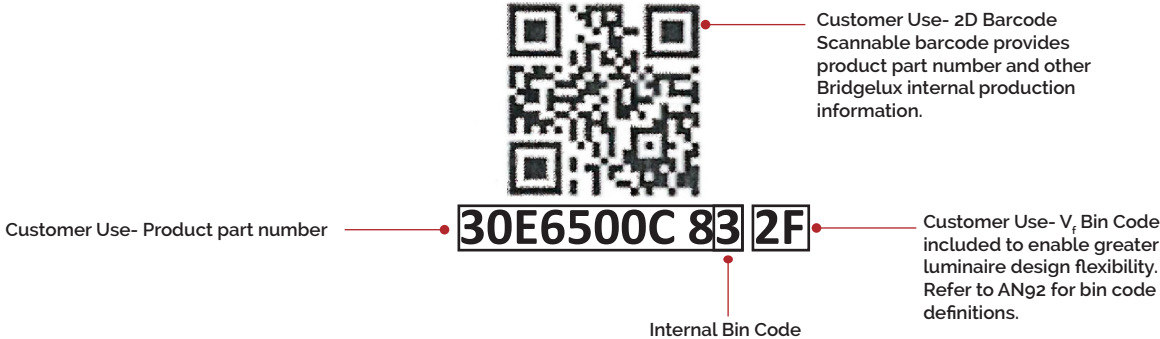

# Design Resources

## Application Notes

Bridgelux has developed a comprehensive set of application notes and design resources to assist customers in successfully designing with the V Series product family of LED array products. For all available application notes visit [www.bridgelux.com](http://www.bridgelux.com).

## Optical Source Models

Optical source models and ray set files are available for all Bridgelux products. For a list of available formats, visit [www.bridgelux.com](http://www.bridgelux.com).

## 3D CAD Models

Three dimensional CAD models depicting the product outline of all Bridgelux V Series LED arrays are available in both IGS and STEP formats. Please contact your Bridgelux sales representative for assistance.

## LM80

Please contact your Bridgelux sales representative for LM-80 report.

# Precautions

## CAUTION: CHEMICAL EXPOSURE HAZARD

Exposure to some chemicals commonly used in luminaire manufacturing and assembly can cause damage to the LED array. Please consult Bridgelux Application Note AN101 for additional information.

## CAUTION: RISK OF BURN

Do not touch the V Series LED array during operation. Allow the array to cool for a sufficient period of time before handling. The V Series LED array may reach elevated temperatures such that could burn skin when touched.

## CAUTION

### CONTACT WITH LIGHT EMITTING SURFACE (LES)

Avoid any contact with the LES. Do not touch the LES of the LED array or apply stress to the LES (yellow phosphor resin area). Contact may cause damage to the LED array.

Optics and reflectors must not be mounted in contact with the LES (yellow phosphor resin area).

# Disclaimers

## MINOR PRODUCT CHANGE POLICY

The rigorous qualification testing on products offered by Bridgelux provides performance assurance. Slight cosmetic changes that do not affect form, fit, or function may occur as Bridgelux continues product optimization.

## STANDARD TEST CONDITIONS

Unless otherwise stated, array testing is performed at the nominal drive current.

# About Bridgelux: Bridging Light and Life™

At Bridgelux, we help companies, industries and people experience the power and possibility of light. Since 2002, we've designed LED solutions that are high performing, energy efficient, cost effective and easy to integrate. Our focus is on light's impact on human behavior, delivering products that create better environments, experiences and returns—both experiential and financial. And our patented technology drives new platforms for commercial and industrial luminaires.

**For more information about the company, please visit**  
**[bridgelux.com](http://bridgelux.com)**  
**[twitter.com/Bridgelux](https://twitter.com/Bridgelux)**  
**[facebook.com/Bridgelux](https://facebook.com/Bridgelux)**  
**[youtube.com/user/Bridgelux](https://youtube.com/user/Bridgelux)**  
**[linkedin.com/company/bridgelux-inc-\\_2](https://linkedin.com/company/bridgelux-inc-_2)**  
**WeChat ID: BridgeluxInChina**



46410 Fremont Boulevard  
Fremont, CA 94538 U.S.A.  
Tel (925) 583-8400  
**[www.bridgelux.com](http://www.bridgelux.com)**

© 2022 Bridgelux, Inc. All rights reserved. Product specifications are subject to change without notice. Bridgelux, the Bridgelux stylized logo design and Vero are registered trademarks. V Series and Decor Series are trademarks of Bridgelux, Inc. All other trademarks are the property of their respective owners.

Bridgelux V22 F90 Array Series Product Data Sheet DS449-3 Rev. A (02/2023)