

Bridgelux® Vero18 F90 Array

Product Data Sheet DS437



Introduction

Vero® F90



The Vero® Series is a revolutionary advancement in chip on board (COB) light source technology and innovation, simplifying the luminaire design and manufacturing processes. Vero Chip on Board (COB) LED arrays are available in four LES configurations, engineered to enable new degrees of flexibility and reliability over a broad range of electrical currents. Vero arrays deliver increased lumen density to enable improved beam control and precision lighting with 2 and 3 SDCM color control standard for clean and consistent uniform lighting.

Vero products include an onboard connector port that enables a solder-free electrical interconnect, and simple mounting features for plug-and-play installation.

The F90 Vero Series COB is a high efficacy product that uses narrow band red phosphor to significantly improve the spectrum efficacy. The improved spectrum efficacy results in the 90 CRI product of the F90 Series delivering better or equivalent efficacy as that of our traditional 80 CRI Vero Series product.

Features

- Efficacy of 185 lm/W typical, 3000K 90 CRI
- Wide selection of CCT options (2700K-5000K) with minimum 90 CRI options
- Uniform high-quality illumination
- 2 and 3 SDCM binning options (2700K – 4000K)
- 3 and 4 SDCM binning options (5000K)
- Forward voltage bin codes and backside marking
- Instant light with unlimited dimming
- Thermally isolated solder pads
- 10-Year warranty

Benefits

- Solder free installation and field upgradability
- Improved inventory management and quality control
- Enables high efficiency lighting systems and lower operating costs
- Supports the trend toward luminaire miniaturization and delivers enhanced optical control
- Design flexibility for a broad range of lighting applications
- Clean white light without pixelation
- Uniform consistent white light
- Design flexibility for multi-source applications
- Enhanced ease of use and installation



Contents

Product Feature Map	2
Product Nomenclature	2
Product Selection Guide	3
European Product Registry for Energy Labeling	4
Performance at Commonly Used Drive Currents	5
Electrical Characteristics	7
Eye Safety	8
Absolute Maximum Ratings	9
Performance Curves	10
Typical Radiation Pattern	12
Typical Color Spectrum	13
Product Bin Definitions	14
Mechanical Dimensions	15
Packaging and Labeling	16
Design Resources	18
Precautions	18
Disclaimers	18
About Bridgelux	19

Product Feature Map

Vero 18 is the second largest form factor in the Vero family of the next generation solid state light sources. In addition to delivering the performance and light quality required for many lighting applications, Vero incorporates

several features to simplify the design integration and manufacturing process, accelerate time to market and reduce system costs. Please visit www.bridgelux.com for more information on the Vero Series family of products.

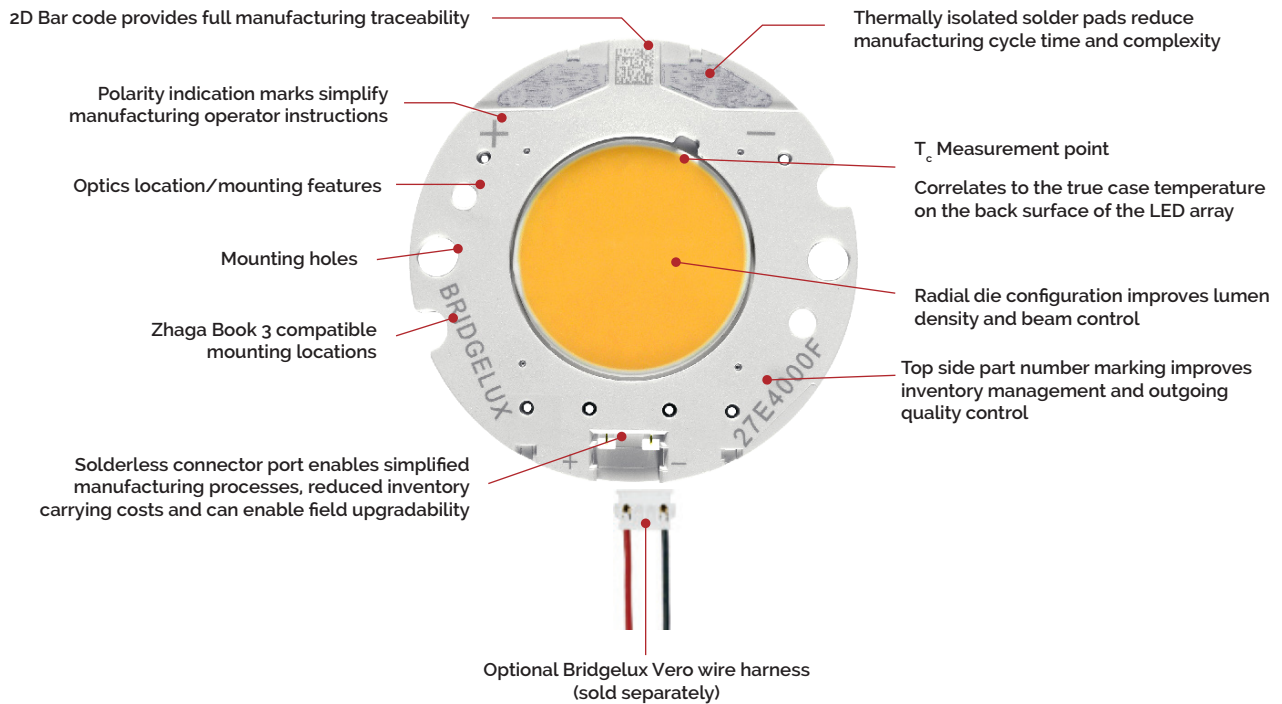

Product Nomenclature

The part number designation for Bridgelux COB arrays is explained as follows:

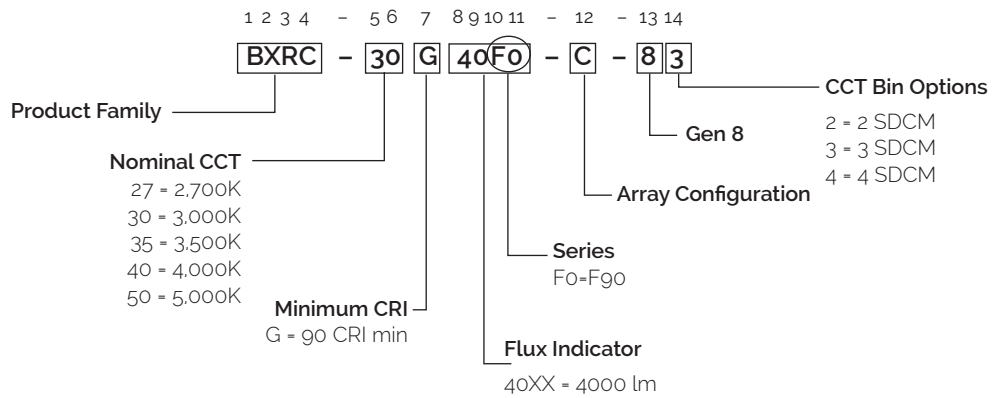

Product Selection Guide

The following product configurations are available:

Table 1: Selection Guide, Pulsed Measurement Data ($T_c = 25^\circ\text{C}$)

Part Number	Nominal CCT ¹ (K)	CRI ²	Nominal Drive Current ³ (mA)	Typical Pulsed Flux ^{4,5,6} $T_c = 25^\circ\text{C}$ (lm)	Minimum Pulsed Flux ^{6,7} $T_c = 25^\circ\text{C}$ (lm)	Typical V_f (V)	Typical Power (W)	Typical Efficacy (lm/W)
BXRC-27G40F0-B-8x	2700	90	700	4388	3950	34.6	24.2	181
BXRC-27G40F0-C-8x	2700	90	1050	6579	5921	34.9	36.7	179
BXRC-30G40F0-B-8x	3000	90	700	4478	4030	34.6	24.2	185
BXRC-30G40F0-C-8x	3000	90	1050	6714	6042	34.9	36.7	183
BXRC-35G40F0-B-8x	3500	90	700	4523	4070	34.6	24.2	187
BXRC-35G40F0-C-8x	3500	90	1050	6781	6103	34.9	36.7	185
BXRC-40G40F0-B-8x	4000	90	700	4567	4111	34.6	24.2	189
BXRC-40G40F0-C-8x	4000	90	1050	6848	6163	34.9	36.7	187
BXRC-50G40F0-B-8x	5000	90	700	4433	3990	34.6	24.2	183
BXRC-50G40F0-C-8x	5000	90	1050	6646	5982	34.9	36.7	181

Table 2: Selection Guide, Stabilized DC Test Performance ($T_c = 85^\circ\text{C}$)^{4,5,6}

Part Number	Nominal CCT (K)	CRI ²	Nominal Drive Current ³ (mA)	Typical DC Flux ^{4,5} $T_c = 85^\circ\text{C}$ (lm)	Minimum DC Flux ⁶ $T_c = 85^\circ\text{C}$ (lm)	Typical V_f (V)	Typical Power (W)	Typical Efficacy (lm/W)
BXRC-27G40F0-B-8x	2700	90	700	4037	3634	34.1	23.9	169
BXRC-27G40F0-C-8x	2700	90	1050	6053	5448	34.4	36.2	167
BXRC-30G40F0-B-8x	3000	90	700	4120	3708	34.1	23.9	173
BXRC-30G40F0-C-8x	3000	90	1050	6177	5559	34.4	36.2	171
BXRC-35G40F0-B-8x	3500	90	700	4161	3745	34.1	23.9	174
BXRC-35G40F0-C-8x	3500	90	1050	6238	5614	34.4	36.2	173
BXRC-40G40F0-B-8x	4000	90	700	4202	3782	34.1	23.9	176
BXRC-40G40F0-C-8x	4000	90	1050	6300	5670	34.4	36.2	174
BXRC-50G40F0-B-8x	5000	90	700	4078	3671	34.1	23.9	171
BXRC-50G40F0-C-8x	5000	90	1050	6115	5503	34.4	36.2	169

Notes for Table 1 & 2:

- Nominal CCT as defined by ANSI C78.377-2011.
- CRI values are minimums and tested at $T_j = T_c = 85^\circ\text{C}$. Minimum Rg value for 90 CRI products is 50. Bridgelux maintains a ± 3 tolerance on CRI and Rg values.
- Drive current is referred to as nominal drive current.
- Products tested under pulsed condition (10ms pulse width) at nominal test current where T_j (junction temperature) - T_c (case temperature) = 25°C .
- Typical performance values are provided as a reference only and are not a guarantee of performance.
- Bridgelux maintains a $\pm 7\%$ tolerance on flux measurements.
- Minimum flux values at the nominal test current are guaranteed by 100% test.

European Product Registry for Energy Labeling

The European Product Registry for Energy Labeling (EPREL) is defined in the EU Regulation 2017/1369 to provide important energy efficiency information to consumers. Together with Energy Labeling Regulation ELR (EU) 2019/2015 which was amended by regulation (EU) 2021/340 for energy labelling of light sources, manufacturers are required to declare an energy class based on key technical specifications from each of their product and register it in an open data base managed by EPREL. It is now a legal requirement for a vendor of light sources to upload information about their products into the EPREL database before placing these products on the market in the EU.

Table 3 below provides a list of part numbers that are in compliance with ELR and are currently listed in the EPREL database.

At Bridgelux, we are fully committed to supplying products that are compliant with pertinent laws, rules, and obligation imposed by relevant government bodies including the European Energy Labeling regulation. Customers can use these products with full confidence for any projects that fall under the ELR.

Table 3: Part numbers registered in European Product Registry for Energy Labeling

PART NUMBER ¹	CCT (K)	CRI	Current ² (mA)	Vf (V)	Useful flux ³ (Φ_{use}) at 85C (lm)	Power (W)	Efficacy (lm/W)	Energy efficiency class ⁴	Registration No	URL to Product Information Sheet in EPREL Database
BXRC-27G40F0-B-83	2700	90	1620	38.0	8283	62	135	E	1332540	https://eprelec.europa.eu/qr/1332540
BXRC-27G40F0-C-83	2700	90	2160	38.0	11157	82	136	E	1332541	https://eprelec.europa.eu/qr/1332541
BXRC-30G40F0-B-83	3000	90	1620	38.0	8452	62	137	E	1332544	https://eprelec.europa.eu/qr/1332544
BXRC-30G40F0-C-83	3000	90	2160	38.0	11385	82	139	E	1332545	https://eprelec.europa.eu/qr/1332545
BXRC-35G40F0-B-83	3500	90	1620	38.0	8537	62	139	E	1332548	https://eprelec.europa.eu/qr/1332548
BXRC-35G40F0-C-83	3500	90	2160	38.0	11498	82	140	E	1332549	https://eprelec.europa.eu/qr/1332549
BXRC-40G40F0-B-83	4000	90	1620	38.0	8621	62	140	E	1332552	https://eprelec.europa.eu/qr/1332552
BXRC-40G40F0-C-83	4000	90	2160	38.0	11612	82	142	E	1332553	https://eprelec.europa.eu/qr/1332553
BXRC-50G40F0-B-84	5000	90	1620	38.0	8368	62	136	E	1332554	https://eprelec.europa.eu/qr/1332554
BXRC-50G40F0-C-84	5000	90	2160	38.0	11271	82	137	E	1332555	https://eprelec.europa.eu/qr/1332555

Notes for Table 3:

1. All device listed here must be disposed as e-waste upon its end of life according to local country guideline in each country.
2. For information on performance values at alternative drive conditions, please refer to the Product Selection Guide, Absolute Maximum Rating Table and Performance Curves in this data sheet.
3. For a definition of useful luminous flux (Φ_{use}), please see the ELR regulations at <https://tinyurl.com/4b6zvt4m>.
4. EPREL requires an arrow symbol containing the letter of the energy efficiency class to be displayed, on technical promotional material. Refer to this energy efficiency class column for specific energy efficiency class on each part number.

Performance at Commonly Used Drive Currents

Vero LED arrays are tested to the specifications shown using the nominal drive currents in Table 1. Vero may also be driven at other drive currents dependent on specific application design requirements. The performance at any drive current can be derived from the current vs. voltage characteristics shown in Figures 1 & 2 and the flux vs. current characteristics shown in Figures 3 & 4. The performance at commonly used drive currents is summarized in Table 4.

Table 4: Product Performance at Commonly Used Drive Currents

Part Number	CRI	Drive Current ¹ (mA)	Typical V_f $T_c = 25^\circ\text{C}$ (V)	Typical Power $T_c = 25^\circ\text{C}$ (W)	Typical Flux ² $T_c = 25^\circ\text{C}$ (lm)	Typical DC Flux ³ $T_c = 85^\circ\text{C}$ (lm)	Typical Efficacy $T_c = 25^\circ\text{C}$ (lm/W)
BXRC-27G40F0-B-8x	90	350	33.2	11.6	2247	2095	194
		525	33.9	17.8	3324	3080	187
		700	34.6	24.2	4388	4037	181
		900	35.4	31.8	5589	5094	176
		1400	37.2	52.1	8520	7540	163
		1620	38.0	61.6	9777	8517	159
BXRC-27G40F0-C-8x	90	525	33.4	17.5	3486	3250	199
		785	34.1	26.8	5141	4764	192
		1050	34.9	36.7	6579	6053	179
		1170	35.3	41.3	7553	6924	183
		2100	37.9	79.6	13184	11668	166
		2160	38.0	82.2	13538	11948	165
BXRC-30G40F0-B-8x	90	350	33.2	11.6	2293	2138	198
		525	33.9	17.8	3392	3143	191
		700	34.6	24.2	4478	4120	185
		900	35.4	31.8	5703	5198	179
		1400	37.2	52.1	8694	7694	167
		1620	38.0	61.6	9977	8691	162
BXRC-30G40F0-C-8x	90	525	33.4	17.5	3557	3316	203
		785	34.1	26.8	5246	4861	196
		1050	34.9	36.7	6714	6177	183
		1170	35.3	41.3	7707	7065	187
		2100	37.9	79.6	13453	11906	169
		2160	38.0	82.2	13814	12192	168
BXRC-35G40F0-B-8x	90	350	33.2	11.6	2316	2159	200
		525	33.9	17.8	3426	3174	193
		700	34.6	24.2	4523	4161	187
		900	35.4	31.8	5760	5250	181
		1400	37.2	52.1	8781	7771	168
		1620	38.0	61.6	10077	8778	164
BXRC-35G40F0-C-8x	90	525	33.4	17.5	3593	3349	205
		785	34.1	26.8	5299	4910	198
		1050	34.9	36.7	6781	6238	185
		1170	35.3	41.3	7784	7136	189
		2100	37.9	79.6	13588	12025	171
		2160	38.0	82.2	13952	12314	170

Notes for Table 4:

1. Alternate drive currents in Table 4 are provided for reference only and are not a guarantee of performance.
2. Bridgelux maintains a $\pm 7\%$ tolerance on flux measurements.
3. Typical stabilized DC performance values are provided as reference only and are not a guarantee of performance.

Performance at Commonly Used Drive Currents

Table 4: Product Performance at Commonly Used Drive Currents (Continued)

Part Number	CRI	Drive Current ¹ (mA)	Typical V_f $T_c = 25^\circ\text{C}$ (V)	Typical Power $T_c = 25^\circ\text{C}$ (W)	Typical Flux ² $T_c = 25^\circ\text{C}$ (lm)	Typical DC Flux ³ $T_c = 85^\circ\text{C}$ (lm)	Typical Efficacy $T_c = 25^\circ\text{C}$ (lm/W)
BXRC-40G40F0-B-8x	90	350	33.2	11.6	2339	2180	202
		525	33.9	17.8	3460	3206	195
		700	34.6	24.2	4567	4202	189
		900	35.4	31.8	5817	5302	183
		1400	37.2	52.1	8868	7848	170
		1620	38.0	61.6	10176	8865	165
BXRC-40G40F0-C-8x	90	525	33.4	17.5	3628	3382	207
		785	34.1	26.8	5351	4959	200
		1050	34.9	36.7	6848	6300	187
		1170	35.3	41.3	7861	7207	190
		2100	37.9	79.6	13722	12144	172
		2160	38.0	82.2	14090	12436	171
BXRC-50G40F0-B-8x	90	350	33.2	11.6	2270	2116	196
		525	33.9	17.8	3358	3111	189
		700	34.6	24.2	4433	4078	183
		900	35.4	31.8	5646	5146	177
		1400	37.2	52.1	8607	7617	165
		1620	38.0	61.6	9877	8604	160
BXRC-50G40F0-C-8x	90	525	33.4	17.5	3522	3283	201
		785	34.1	26.8	5194	4813	194
		1050	34.9	36.7	6646	6115	181
		1170	35.3	41.3	7630	6995	185
		2100	37.9	79.6	13319	11787	167
		2160	38.0	82.2	13676	12070	166

Notes for Table 4:

1. Alternate drive currents in Table 4 are provided for reference only and are not a guarantee of performance.
2. Bridgelux maintains a $\pm 7\%$ tolerance on flux measurements.
3. Typical stabilized DC performance values are provided as reference only and are not a guarantee of performance.

Electrical Characteristics

Table 5: Electrical Characteristics

Part Number	Drive Current (mA)	Forward Voltage Pulsed, $T_c = 25^\circ\text{C}$ (V) ^{1, 2, 3, 8}			Typical Coefficient of Forward Voltage ⁴ $\Delta V_f / \Delta T_c$ (mV/ $^\circ\text{C}$)	Typical Thermal Resistance Junction to Case ^{5,6} R_{j-c} ($^\circ\text{C}/\text{W}$)	Driver Selection Voltages ⁷ (V)	
		Minimum	Typical	Maximum			V_f Min. Hot $T_c = 105^\circ\text{C}$ (V)	V_f Max. Cold $T_c = -40^\circ\text{C}$ (V)
BXRC-xxx40F0-B-8x	700	32.5	34.6	36.7	-10	0.14	31.8	37.3
	1620	35.7	38.0	40.3	-11	0.23	35.0	41.0
BXRC-xxx40F0-C-8x	1050	32.8	34.9	37.0	-10	0.12	32.1	37.7
	2160	35.8	38.0	40.3	-11	0.20	35.0	41.1

Notes for Table 5:

- Parts are tested in pulsed conditions, $T_c = 25^\circ\text{C}$. Pulse width is 10ms.
- Voltage minimum and maximum are provided for reference only and are not a guarantee of performance.
- Bridgelux maintains a tester tolerance of $\pm 0.10\text{V}$ on forward voltage measurements.
- Typical coefficient of forward voltage tolerance is $\pm 0.1\text{mV}$ for nominal current.
- Thermal resistance values are based from test data of a 3000K 80 CRI product.
- Thermal resistance value was calculated using total electrical input power; optical power was not subtracted from input power. The thermal interface material used during testing is not included in the thermal resistance value.
- V_f min hot and max cold values are provided as reference only and are not guaranteed by test. These values are provided to aid in driver design and selection over the operating range of the product.
- This product has been designed and manufactured per IEC 62031:2018. This product has passed dielectric withstand voltage testing at 1160 V. The working voltage designated for the insulation is 80V d.c. The maximum allowable voltage across the array must be determined in the end product application.

Eye Safety

Table 6: Eye Safety Risk Group (RG) Classifications

Part Number	Drive Current (mA)	CCT ⁵		
		2700K/3000K	4000K ²	5000K ³
BXRC-xxx40F0-B-8x	1620	RG1	RG1	RG1
BXRC-xxx40F0-C-8x	1995	RG1	RG1	RG1
	2160	RG1	RG1	RG2

Notes for Table 6:

1. Eye safety classification for the use of Bridgelux V Series LED arrays is in accordance with specification IEC/TR 62778: Application of IEC 62471 for the assessment of blue light hazard to light sources and luminaires.
2. For products classified as RG2 at 4000K, Ethr= 1980 lx.
3. For products classified as RG2 at 5000K Ethr= 1530 lx.
4. For products classified as RG2 at 6500K, Ethr= 1170 lx.
5. Please contact your Bridgelux sales representative for Ethr values at specific drive currents and CCTs not listed.

Absolute Maximum Ratings

Table 7: Maximum Ratings

Parameter	Maximum Rating	
LED Junction Temperature (T_j)	150°C	
Storage Temperature ¹	-40°C to +95°C	
Operating Case Temperature ² (T_c)	95°C	
Soldering Temperature ³	300°C or lower for a maximum of 6 seconds	
	BXRC-xxx40F0-B-8x	BXRC-xxx40F0-C-8x
Maximum Drive Current ⁴	1620 mA at ≤85°C 1215 mA at 95°C	2160 mA at ≤85°C 1620 mA at 95°C
Maximum Peak Pulsed Drive Current ⁵	2320mA	3090 mA
Maximum Reverse Voltage ⁶	-60V	-60V

Notes for Table 7:

1. The F90 product is robust enough to pass our internal humidity test but it is still more sensitive compared to regular LED array product. The product needs to be stored in a dry environment. It is not recommended to use the product in a damp environment that directly exposes it to moisture.
2. For IEC 62717 requirement, please consult your Bridgelux sales representative.
3. Refer to Bridgelux Application Note AN31: Assembly Considerations for Bridgelux Vero LED Arrays.
4. Arrays may be driven at higher currents however lumen maintenance may be reduced and warranty will not apply.
5. Bridgelux recommends a maximum duty cycle of 10% and pulse width of 20 ms when operating LED Arrays at maximum peak pulsed current specified. Maximum peak pulsed currents indicate values where LED Arrays can be driven without catastrophic failures.
6. Light emitting diodes are not designed to be driven in reverse voltage and will not produce light under this condition. Maximum rating provided for reference only.

Performance Curves

Figure 1: Vero18B Drive Current vs. Voltage

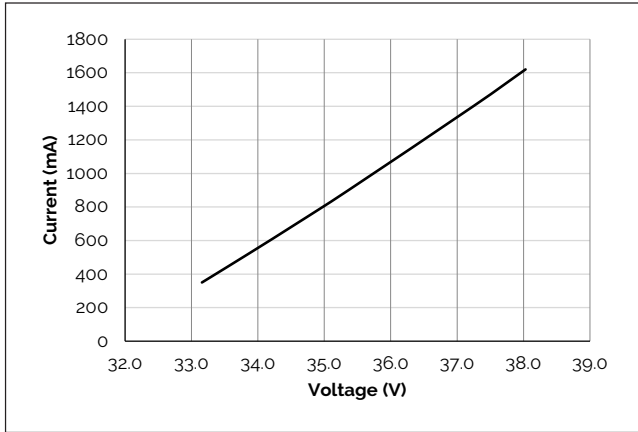

Figure 2: Vero18C Drive Current vs. Voltage

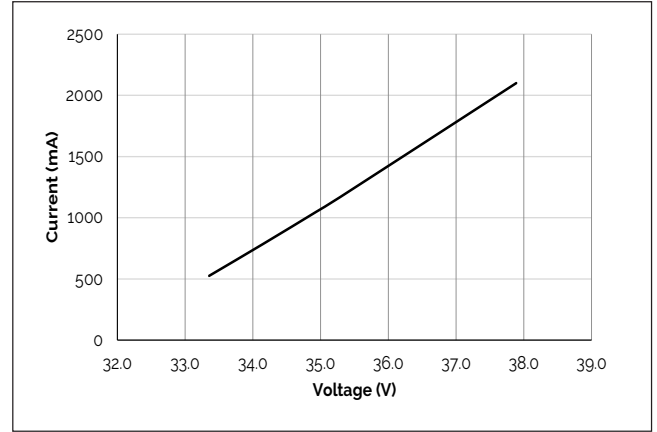

Figure 3: Vero18B Typical Relative Flux vs. Current

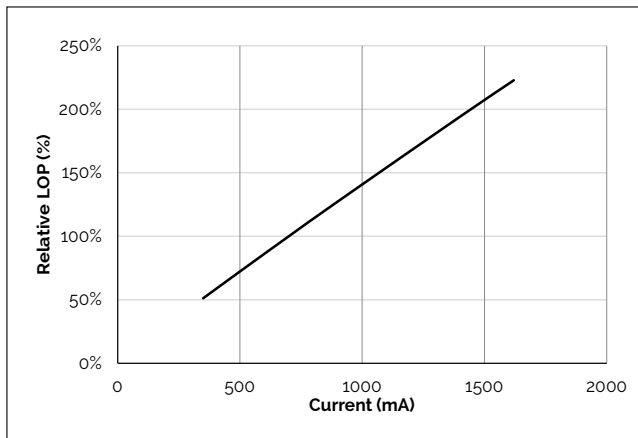

Figure 4: Vero18C Typical Relative Flux vs. Current

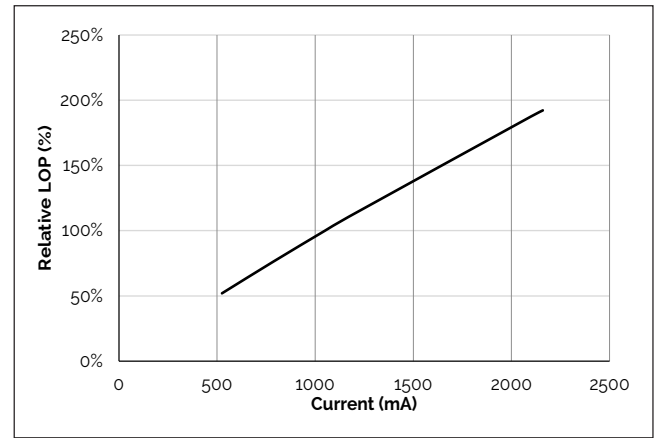

Figure 5: Typical DC Flux vs. Case Temperature

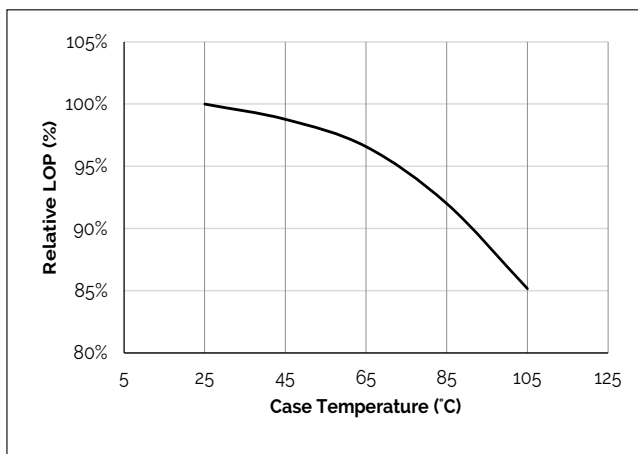
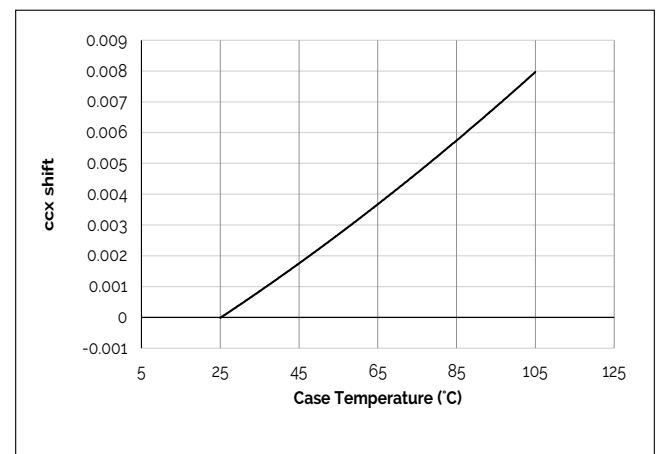

Figure 6: Typical DC cxx Shift vs. Case Temperature



Notes for Figures 1-4:

1. Bridgelux does not recommend driving high power LEDs at low currents. Doing so may produce unpredictable results. Pulse width modulation (PWM) is recommended for dimming effects.
2. Products tested under pulsed condition (10ms pulse width) at nominal test current where T_j (junction temperature) = T_c (case temperature) = 25°C.

Note for Figures 5-6:

1. Characteristics shown for Warm White.

Performance Curves

Figure 7: Typical DC ccy Shift vs. Case Temperature

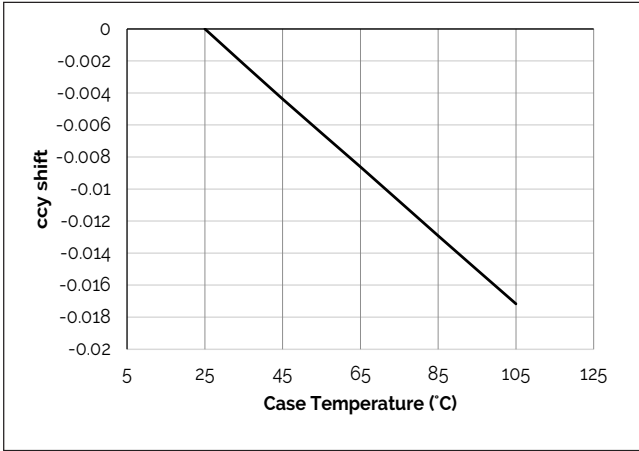

Figure 8: Vero18B Drive Current vs. ccx Shift

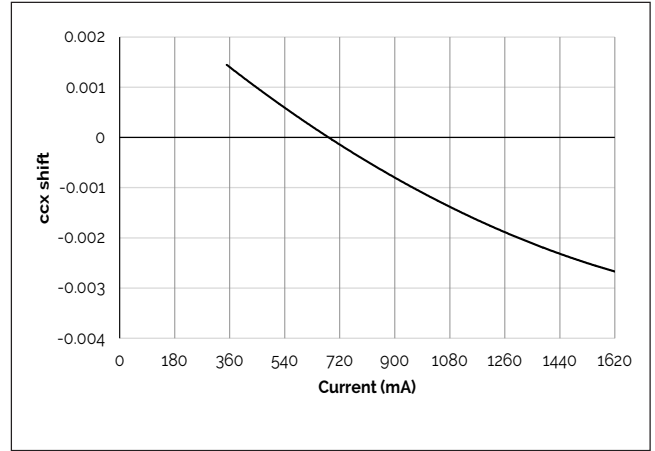

Figure 9: Vero18B Drive Current vs. ccy Shift

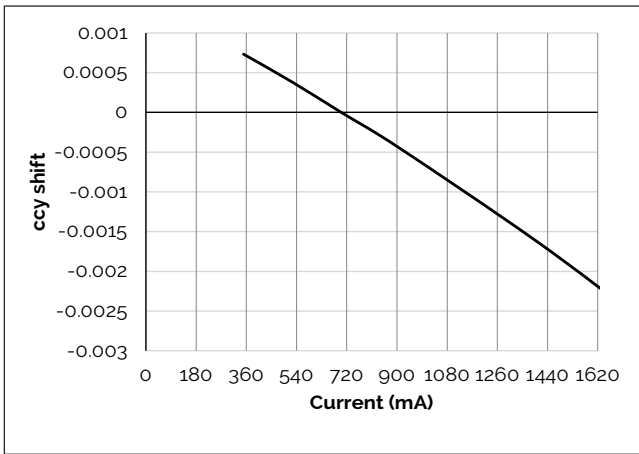

Figure 10: Vero18C Drive Current vs. ccx Shift

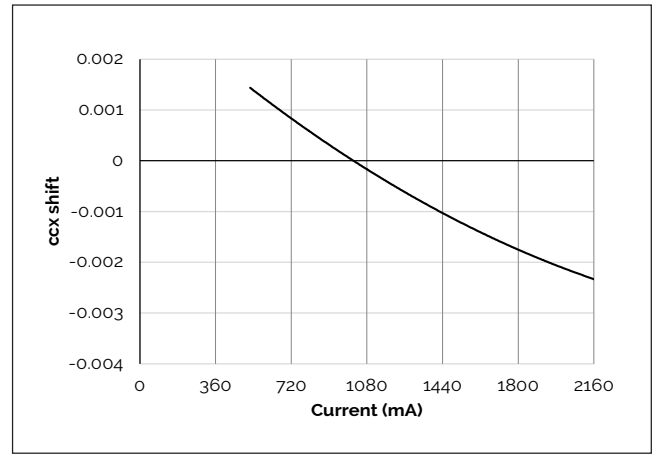

Figure 11: Vero18C Drive Current vs. ccy Shift

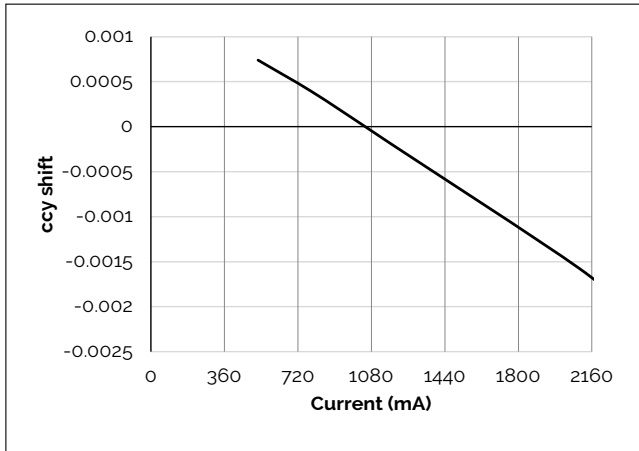
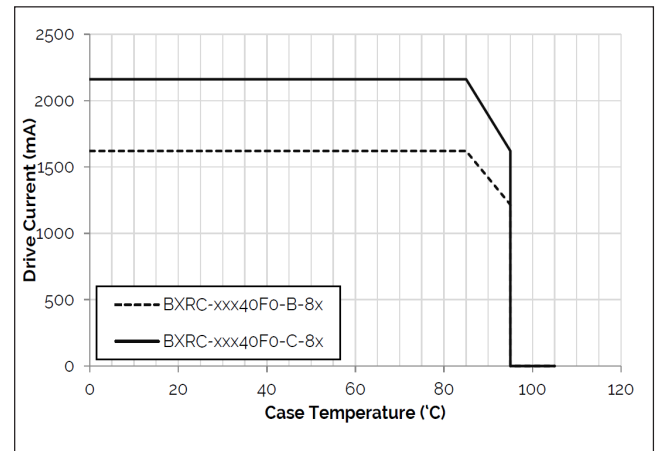

Figure 12: Derating Curve



Note for Figures 5-9:
1. Characteristics shown for Warm White.

Typical Radiation Pattern

Figure 13: Typical Spatial Radiation Pattern

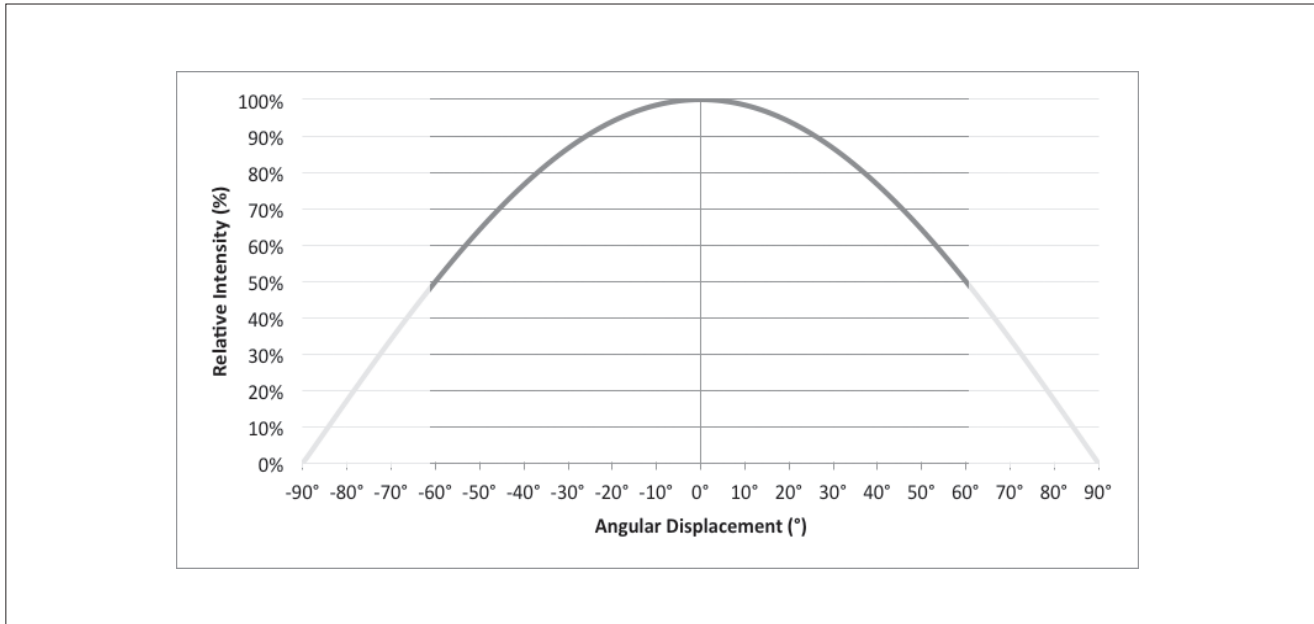

Notes for Figure 13:

1. Typical viewing angle is 120°.
2. The viewing angle is defined as the off axis angle from the centerline where intensity is ½ of the peak value.

Figure 14: Typical Polar Radiation Pattern

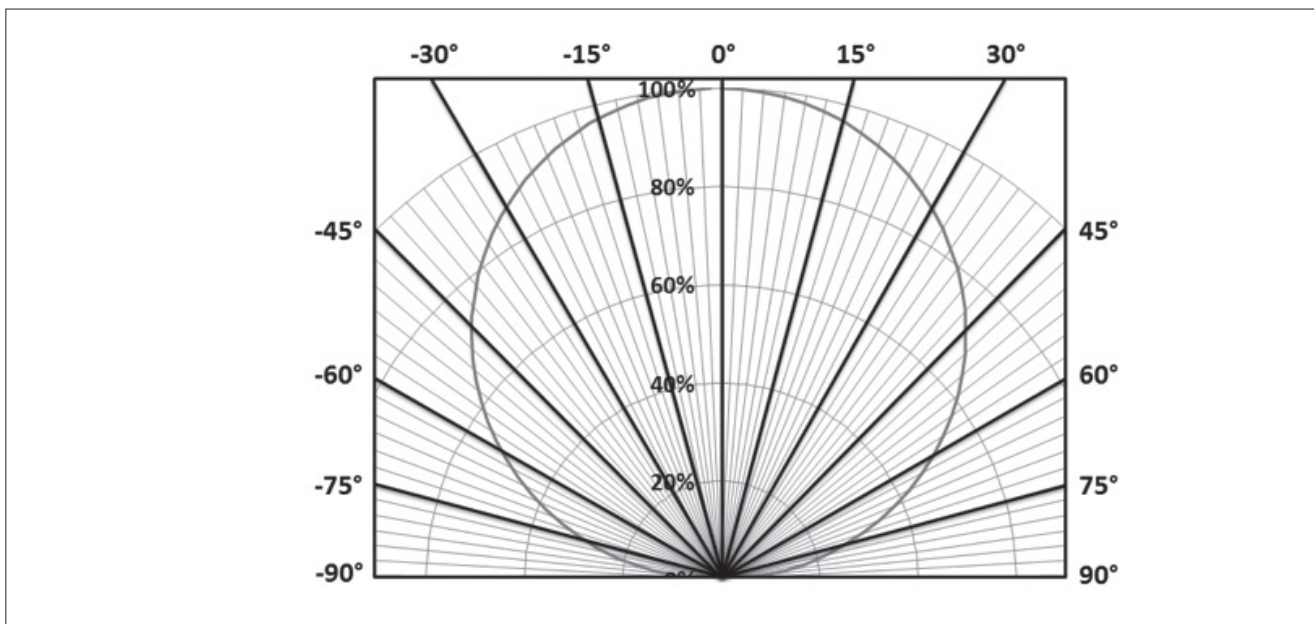

Typical Color Spectrum

Figure 15: Typical Color Spectrum

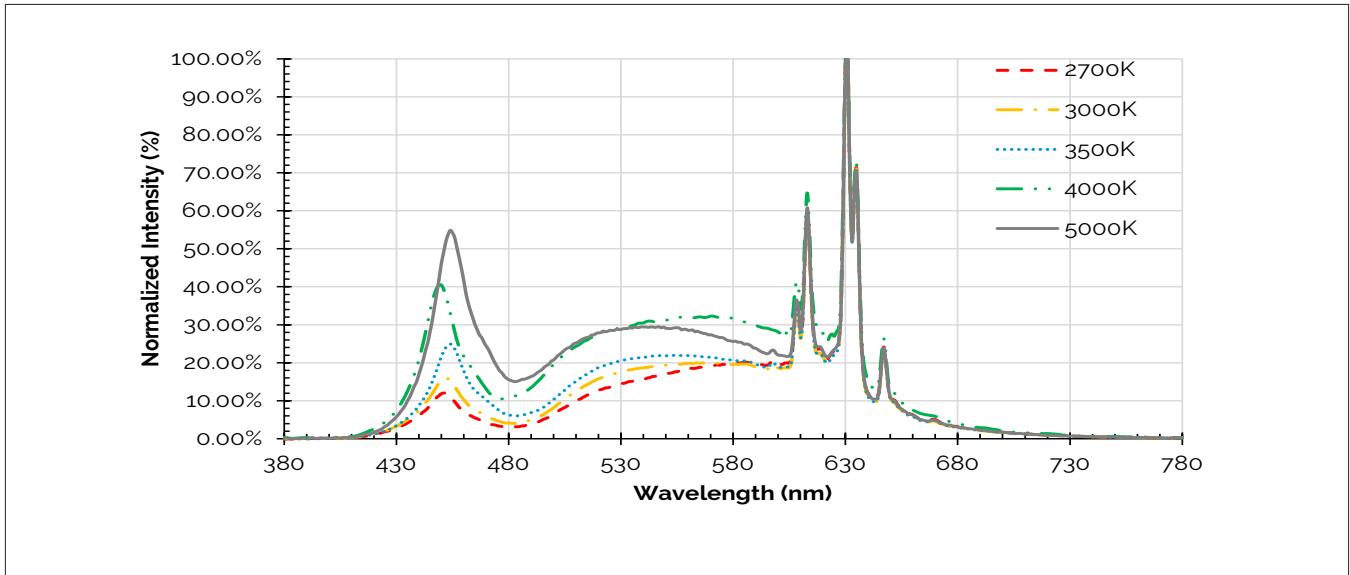

Notes for Figure 15:

1. Color spectra measured at nominal current for $T_j = T_c = 85^\circ\text{C}$.
2. Color spectra shown is 2700K and 90CRI.
3. Color spectra shown is 3000K and 90 CRI.
4. Color spectra shown is 3500K and 90 CRI.
5. Color spectra shown is 4000K and 90 CRI.
6. Color spectra shown is 5000K and 90 CRI.

Color Binning Information

Figure 16: Warm, Neutral and Cool White Test Bins in xy Color Space

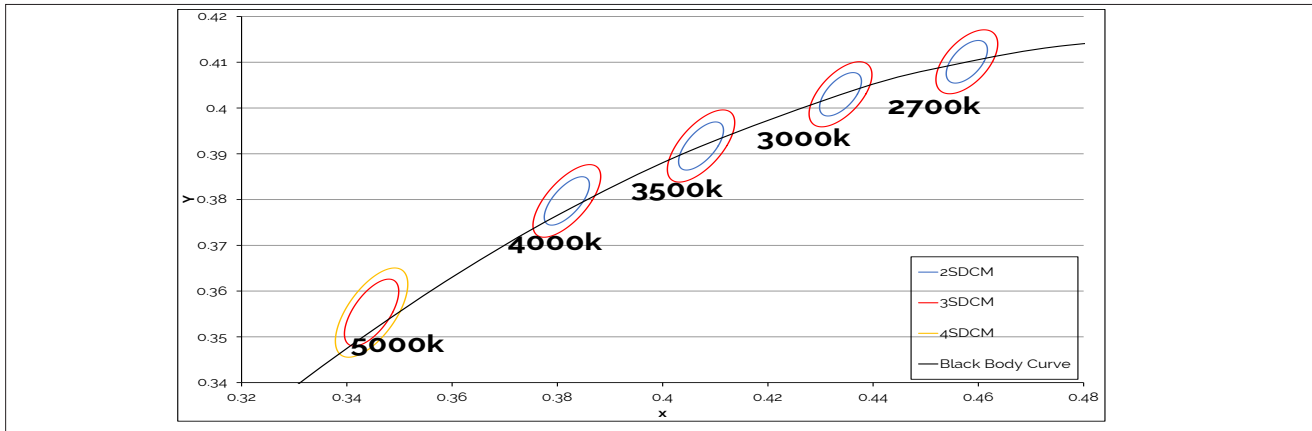

Note: Pulsed Test Conditions, $T_c = 85^\circ\text{C}$

Table 8: Warm and Neutral White xy Bin Coordinates and Associated Typical CCT (product is hot targeted to $T_c = 85^\circ\text{C}$)

Bin Code	2700K	3000K	3500K	4000K
ANSI Bin (for reference only)	(2580K - 2870K)	(2870K - 3220K)	(3220K - 3710K)	(3710K - 4260K)
83 (3 SDCM)	(2651K - 2794K)	(2968K - 3136K)	(3369K - 3586K)	(3851K - 4130K)
82 (2 SDCM)	(2674K - 2769K)	(2995K - 3107K)	(3404K - 3548K)	(3895K - 4081K)
Center Point (x,y)	(0.4578, 0.4101)	(0.4338, 0.403)	(0.4073, 0.3917)	(0.3818, 0.3797)

Table 9: Cool White xy Bin Coordinates and Associated Typical CCT (product is hot targeted to $T_c = 85^\circ\text{C}$)

Bin Code	5000K
ANSI Bin (for reference only)	(4745K - 5311K)
84 (4 SDCM)	(4801K - 5282K)
83 (3 SDCM)	(4835K - 5215K)
Center Point (x,y)	(0.3447, 0.3553)

Note for Tables 8-g:

1. Bridgelux maintains a tolerance of +/- 0.007 on x and y color coordinates in the CIE 1931 color Space.

Mechanical Dimensions

Figure 17: Drawing for Vero18 LED Array

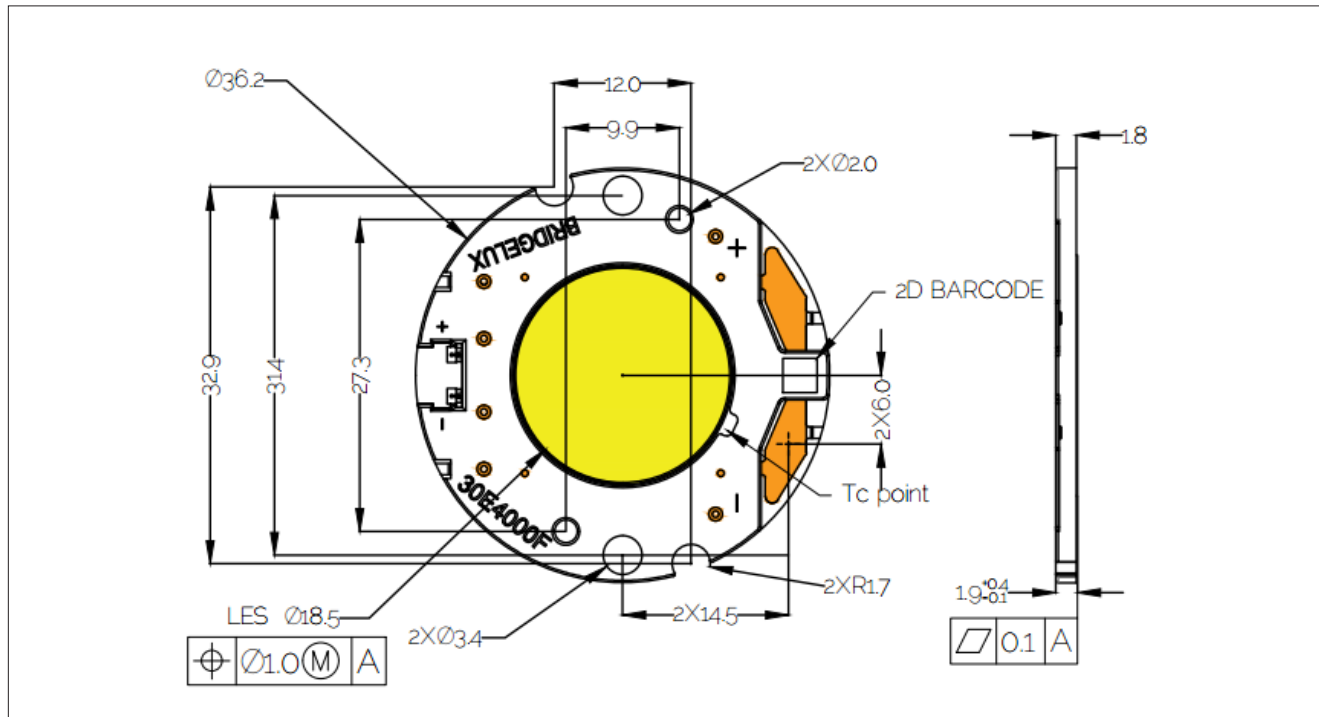

Notes for Figure 17:

1. Drawings are not to scale.
2. Drawing dimensions are in millimeters.
3. Unless otherwise specified, tolerances are $\pm 0.1\text{mm}$.
4. Mounting holes (2X) are for M2.5 screws.
5. Bridgelux recommends two tapped holes for mounting screws with $31.4 \pm 0.10\text{mm}$ center-to-center spacing.
6. Screws with flat shoulders (pan, dome, button, round, truss, mushroom) provide optimal torque control. Do NOT use flat, countersink, or raised head screws.
7. Solder pads and connector port are labeled "+" and "-" to denote positive and negative, respectively.
8. It is not necessary to provide electrical connections to both the solder pads and the connector port. Either set may be used depending on application specific design requirements.
9. Refer to Application Notes AN30 and AN31 for product handling, mounting and heat sink recommendations.
10. The optical center of the LED Array is nominally defined by the mechanical center of the array to a tolerance of $\pm 0.2\text{mm}$.
11. Bridgelux maintains a flatness of 0.10mm across the mounting surface of the array.

Packaging and Labeling

Figure 18: Drawing for Vero 18 Packaging Tray

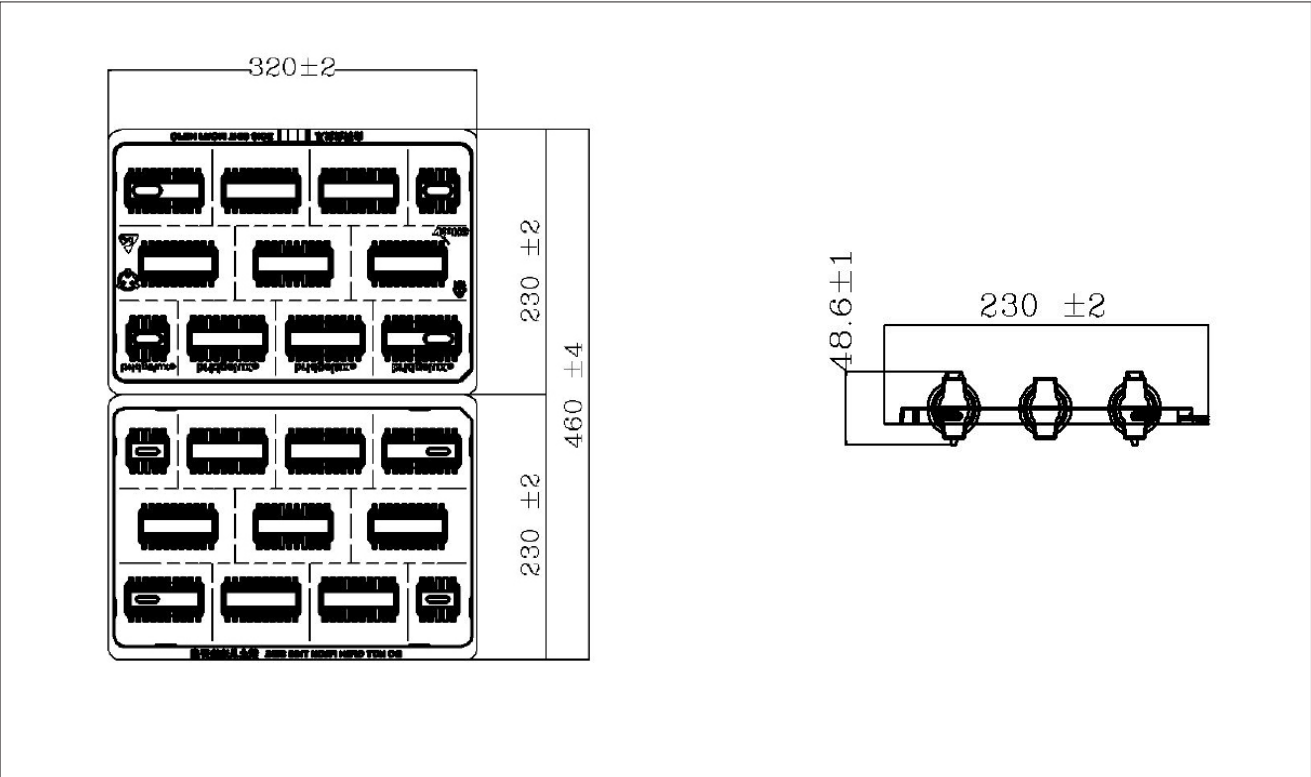

- Notes for Figure 18:
1. Dimensions are in millimeters.
 2. Drawings are not to scale.

Packaging and Labeling

Figure 19: Vero Series Packaging and Labeling

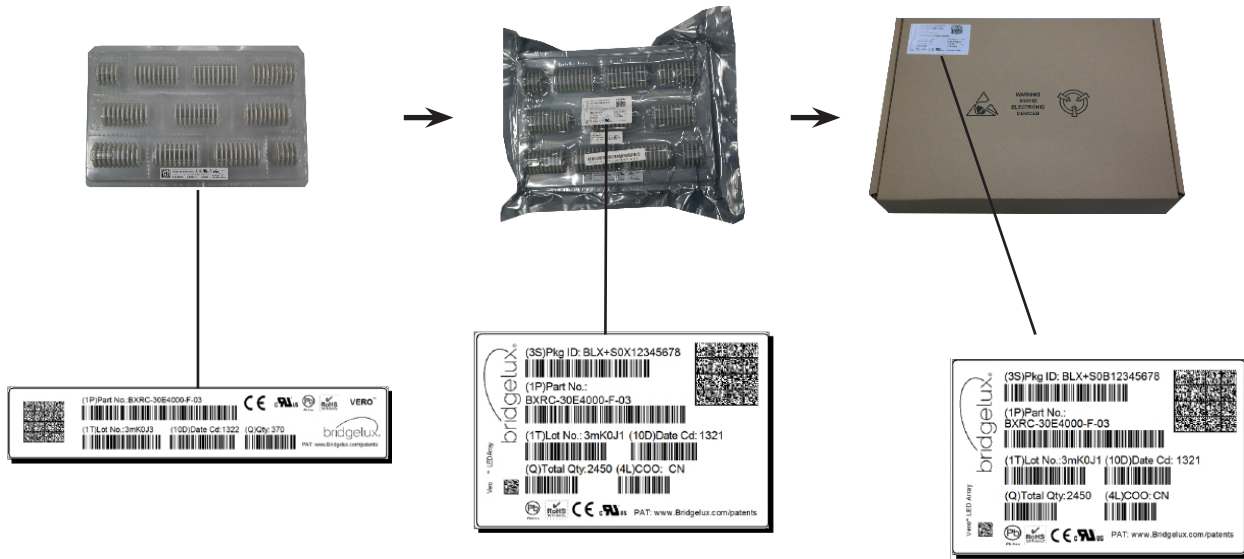

Notes for Figure 19:

1. Each tray holds 100 COBs.
2. Each tray is vacuum sealed in an anti-static bag and placed in its own box.
3. Each tray, bag and box is to be labeled as shown above.

Figure 20: Product Labeling

Bridgelux COB arrays have laser markings on the back side of the substrate to help with product identification. In addition to the product identification markings, Bridgelux COB arrays also contain markings for internal Bridgelux manufacturing use only. The image below shows which markings are for customer use and which ones are for Bridgelux internal use only. The Bridgelux internal manufacturing markings are subject to change without notice, however these will not impact the form, function or performance of the COB array.



Design Resources

Application Notes

Bridgelux has developed a comprehensive set of application notes and design resources to assist customers in successfully designing with the Vero product family of LED array products. For all available application notes visit www.bridgelux.com.

Optical Source Models

Optical source models and ray set files are available for all Bridgelux products. For a list of available formats, visit www.bridgelux.com.

3D CAD Models

Three dimensional CAD models depicting the product outline of all Bridgelux Vero LED arrays are available in both IGS and STEP formats. Please contact your Bridgelux sales representative for assistance.

LM80

LM80 testing has been completed and the LM80 report is now available. Please contact your Bridgelux sales representative for LM-80 report.

Precautions

CAUTION: CHEMICAL EXPOSURE HAZARD

Exposure to some chemicals commonly used in luminaire manufacturing and assembly can cause damage to the LED array. Please consult Bridgelux Application Note AN31 for additional information.

CAUTION: RISK OF BURN

Do not touch the Vero LED array during operation. Allow the array to cool for a sufficient period of time before handling. The Vero LED array may reach elevated temperatures such that could burn skin when touched.

CAUTION

CONTACT WITH LIGHT EMITTING SURFACE (LES)

Avoid any contact with the LES. Do not touch the LES of the LED array or apply stress to the LES (yellow phosphor resin area). Contact may cause damage to the LED array.

Optics and reflectors must not be mounted in contact with the LES (yellow phosphor resin area). Optical devices may be mounted on the top surface of the plastic housing of the Vero LED array. Use the mechanical features of the LED array housing, edges and/or mounting holes to locate and secure optical devices as needed.

Disclaimers

MINOR PRODUCT CHANGE POLICY

The rigorous qualification testing on products offered by Bridgelux provides performance assurance. Slight cosmetic changes that do not affect form, fit, or function may occur as Bridgelux continues product optimization.

STANDARD TEST CONDITIONS

Unless otherwise stated, array testing is performed at the nominal drive current.

About Bridgelux: Bridging Light and Life™

At Bridgelux, we help companies, industries and people experience the power and possibility of light. Since 2002, we've designed LED solutions that are high performing, energy efficient, cost effective and easy to integrate. Our focus is on light's impact on human behavior, delivering products that create better environments, experiences and returns—both experiential and financial. And our patented technology drives new platforms for commercial and industrial luminaires.

For more information about the company, please visit

bridgelux.com

twitter.com/Bridgelux

facebook.com/Bridgelux

linkedin.com/company/bridgelux-inc-_2

youtube.com/user/Bridgelux

WeChat ID: BridgeluxInChina



46410 Fremont Boulevard

Fremont, CA 94538 USA

Tel (925) 583-8400

www.bridgelux.com