



# Bridgelux® Gen 8 Vg HD F90 TS LED Array

Product Data Sheet DS1362



# Introduction

V Series HD



V Series™ HD LED array product, an ultra-high lumen density COB product line, is designed for high intensity spotlights used in commercial and retail settings. V Series HD arrays offer industry leading color over angle uniformity, and replace ceramic metal halide lamps by providing equal or greater center beam candle power at lower power and at greater lifetimes. Their tight beam control and exceptional quality of light is well suited for demanding directional spot applications.

The Vg HD F90 COB is a high efficacy product that uses narrow band red phosphor to significantly improve the spectrum efficacy. The improved spectrum efficacy results in the 90 CRI product of the F90 Series delivering better or equivalent efficacy as that of our traditional 80 CRI V Series product.

Lighting system designs incorporating these LED arrays deliver increased system level efficacy and longer service life. Typical applications include, but are not limited to, commercial and residential down lights, accent, spot and track lights.

## Features

- Efficacy of 137 lm/W typical for 3000K 90 CRI
- Compact high flux density light source
- Uniform high quality illumination
- Minimum 90 CRI options
- Streamlined thermal path
- ENERGY STAR® / ANSI compliant color binning structure with 3 SDCM options
- More energy efficient than incandescent, halogen and fluorescent lamps
- Low voltage DC operation
- Instant light with unlimited dimming
- V<sub>f</sub> bin code backside marking

## Benefits

- Enhanced optical control
- Clean white light without pixelation
- High quality true color reproduction
- Significantly reduced thermal resistance and increased operating temperatures
- Uniform consistent white light
- Lower operating costs
- Easy to use with daylight and motion detectors to enable increased energy savings
- Reduced maintenance costs
- Environmentally friendly, no disposal issue



# Contents

Product Feature Map	2
Product Nomenclature	2
Product Selection Guide	3
European Product Registry for Energy Labeling	5
Performance at Commonly Used Drive Currents	6
Electrical Characteristics	8
Eye Safety	9
Absolute Maximum Ratings	10
Performance Curves	11
Typical Radiation Pattern	13
Typical Color Spectrum	14
Mechanical Dimensions	15
Color Binning Information	16
Packaging and Labeling	17
Design Resources	19
Precautions	19
Disclaimers	19
About Bridgelux	20

# Product Feature Map

Bridgelux arrays are fully engineered devices that provide consistent thermal and optical performance on an engineered mechanical platform. The V Series HD arrays are the most compact chip-on-board devices across all of Bridgelux's LED Array products.

The arrays incorporate several features to simplify design integration and assembly. Please visit [www.bridgelux.com](http://www.bridgelux.com) for more information on the V Series HD family of products.

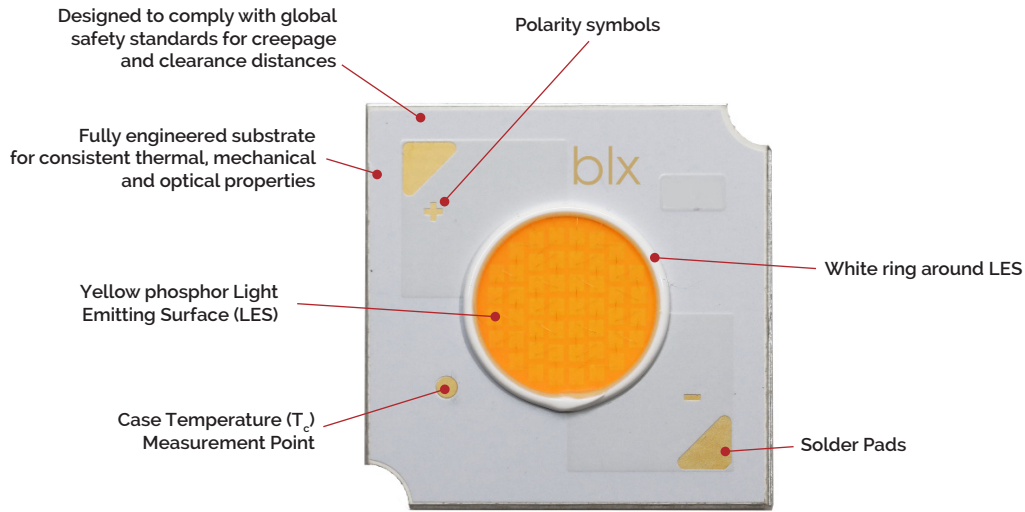

Note: Part number and lot codes are scribed on back of array

## Product Nomenclature

The part number designation for Bridgelux V Series HD LED arrays is explained as follows:

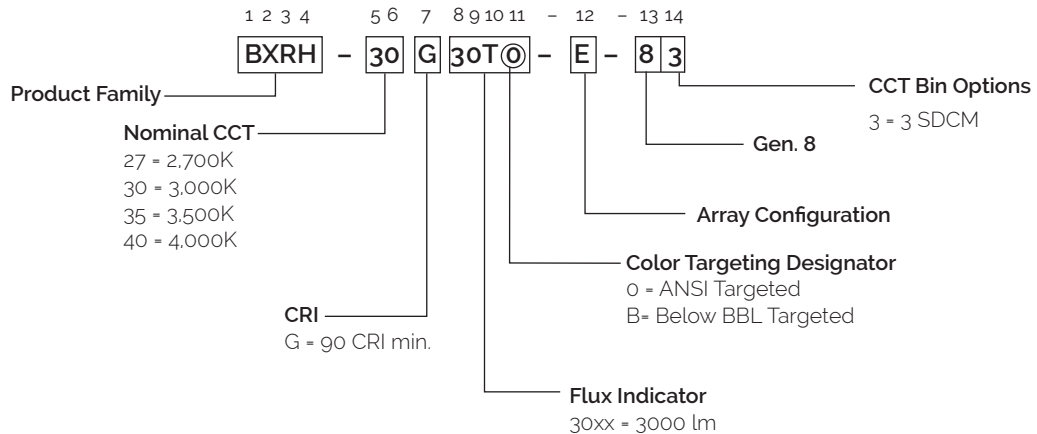

# Product Selection Guide

The following product configurations are available:

**Table 1:** Selection Guide, Pulsed Measurement Data ( $T_j = T_c = 25^\circ\text{C}$ )

Part Number	Nominal CCT <sup>1</sup> (K)	CRI <sup>2</sup>	Nominal Drive Current <sup>3</sup> (mA)	Typical Pulsed Flux <sup>4,5,6</sup> $T_c = 25^\circ\text{C}$ (lm)	Minimum Pulsed Flux <sup>6,7</sup> $T_c = 25^\circ\text{C}$ (lm)	Typical $V_f$ (V)	Typical Power (W)	Typical Efficacy (lm/W)
BXRH-27G30To-E-8x	2700	90	700	3110	2799	33.9	23.7	131
BXRH-27G30TB-E-8x	2700	90	700	3110	2799	33.9	23.7	131
BXRH-30G30To-E-8x	3000	90	700	3240	2916	33.9	23.7	137
BXRH-30G30TB-E-8x	3000	90	700	3159	2843	33.9	23.7	133
BXRH-35G30To-E-8x	3500	90	700	3272	2945	33.9	23.7	138
BXRH-35G30TB-E-8x	3500	90	700	3222	2900	33.9	23.7	136
BXRH-40G30To-E-8x	4000	90	700	3361	3025	33.9	23.7	142
BXRH-40G30TB-E-8x	4000	90	700	3332	2999	33.9	23.7	141

Notes for Table 1:

1. Nominal CCT as defined by ANSI C78.377-2011.
2. CRI values are minimums and tested at  $T_j = T_c = 85^\circ\text{C}$ . Minimum Rg value for 90 CRI products is 50. Bridgelux maintains a  $\pm 3$  tolerance on CRI and Rg values.
3. Drive current is referred to as nominal drive current.
4. Products tested under pulsed condition (10ms pulse width) at nominal drive current where  $T_j$  (junction temperature) =  $T_c$  (case temperature) =  $25^\circ\text{C}$ .
5. Typical performance values are provided as a reference only and are not a guarantee of performance.
6. Bridgelux maintains a  $\pm 7\%$  tolerance on flux measurements.
7. Minimum flux values at the nominal drive current are guaranteed by 100% test.

# Product Selection Guide

**Table 2:** Selection Guide, Stabilized DC Performance ( $T_c = 85^\circ\text{C}$ )

Part Number	Nominal CCT <sup>1</sup> (K)	CRI <sup>2</sup>	Nominal Drive Current <sup>3</sup> (mA)	Typical DC Flux <sup>4,5</sup> $T_c = 85^\circ\text{C}$ (lm)	Minimum DC Flux <sup>6</sup> $T_c = 85^\circ\text{C}$ (lm)	Typical $V_f$ (V)	Typical Power (W)	Typical Efficacy (lm/W)
BXRH-27G30To-E-8x	2700	90	700	2799	2519	33.1	23.2	121
BXRH-27G30TB-E-8x	2700	90	700	2799	2519	33.1	23.2	121
BXRH-30G30To-E-8x	3000	90	700	2916	2624	33.1	23.2	126
BXRH-30G30TB-E-8x	3000	90	700	2843	2559	33.1	23.2	123
BXRH-35G30To-E-8x	3500	90	700	2945	2650	33.1	23.2	127
BXRH-35G30TB-E-8x	3500	90	700	2900	2610	33.1	23.2	125
BXRH-40G30To-E-8x	4000	90	700	3025	2722	33.1	23.2	131
BXRH-40G30TB-E-8x	4000	90	700	2999	2699	33.1	23.2	129

Notes for Table 2:

- Nominal CCT as defined by ANSI C78.377-2011.
- CRI values are minimums and tested at  $T_j = T_c = 85^\circ\text{C}$ . Minimum Rg value for 90 CRI products is 50.
- Drive current is referred to as nominal drive current.
- Typical stabilized DC performance values are provided as reference only and are not a guarantee of performance.
- Typical performance is estimated based on operation under DC (direct current) with LED array mounted onto a heat sink with thermal interface material and the case temperature maintained at  $85^\circ\text{C}$ . Based on Bridgelux test setup, values may vary depending on the thermal design of the luminaire and/or the exposed environment to which the product is subjected.
- Minimum flux values at elevated temperatures are provided for reference only and are not guaranteed by 100% production testing. Based on Bridgelux test setup, values may vary depending on the thermal design of the luminaire and/or the exposed environment to which the product is subjected.

# European Product Registry for Energy Labeling

The European Product Registry for Energy Labeling (EPREL) is defined in the EU Regulation 2017/1369 to provide important energy efficiency information to consumers. Together with Energy Labeling Regulation ELR (EU) 2019/2015 which was amended by regulation (EU) 2021/340 for energy labelling of light sources, manufacturers are required to declare an energy class based on key technical specifications from each of their product and register it in an open data base managed by EPREL. It is now a legal requirement for a vendor of light sources to upload information about their products into the EPREL database before placing these products on the market in the EU.

Table 3 below provides a list of part numbers that are in compliance with ELR and are currently listed in the EPREL database.

At Bridgelux, we are fully committed to supplying products that are compliant with pertinent laws, rules, and obligation imposed by relevant government bodies including the European Energy Labeling regulation. Customers can use these products with full confidence for any projects that fall under the ELR.

**Table 3:** Part numbers registered in European Product Registry for Energy Labeling

PART NUMBER <sup>1</sup>	CCT (K)	CRI	Current <sup>2</sup> (mA)	Vf (V)	Useful flux <sup>3</sup> ( $\Phi_{use}$ ) at 85C (lm)	Power (W)	Efficacy (lm/W)	Energy efficiency class <sup>4</sup>	Registration No	URL to Product Information Sheet in EPREL Database
BXRH-27G30To-E-83	2700	90	1000	33.3	3718	33	112	F	1848637	<a href="https://eprelec.europa.eu/qr/1848637">https://eprelec.europa.eu/qr/1848637</a>
BXRH-27G30TB-E-83	2700	90	1000	33.3	3718	33	112	F	1848638	<a href="https://eprelec.europa.eu/qr/1848638">https://eprelec.europa.eu/qr/1848638</a>
BXRH-30G30To-E-83	3000	90	1000	33.3	3873	33	116	F	1848643	<a href="https://eprelec.europa.eu/qr/1848643">https://eprelec.europa.eu/qr/1848643</a>
BXRH-30G30TB-E-83	3000	90	1000	33.3	3776	33	114	F	1848644	<a href="https://eprelec.europa.eu/qr/1848644">https://eprelec.europa.eu/qr/1848644</a>
BXRH-35G30To-E-83	3500	90	1000	33.3	3911	33	118	F	1848649	<a href="https://eprelec.europa.eu/qr/1848649">https://eprelec.europa.eu/qr/1848649</a>
BXRH-35G30TB-E-83	3500	90	1000	33.3	3852	33	116	F	1848650	<a href="https://eprelec.europa.eu/qr/1848650">https://eprelec.europa.eu/qr/1848650</a>
BXRH-40G30To-E-83	4000	90	1000	33.3	4018	33	121	E	1848655	<a href="https://eprelec.europa.eu/qr/1848655">https://eprelec.europa.eu/qr/1848655</a>
BXRH-40G30TB-E-83	4000	90	1000	33.3	3983	33	120	E	1848656	<a href="https://eprelec.europa.eu/qr/1848656">https://eprelec.europa.eu/qr/1848656</a>

Notes for Table 3:

1. All device listed here must be disposed as e-waste upon its end of life according to local country guideline in each country.
2. For information on performance values at alternative drive conditions, please refer to the Product Selection Guide, Absolute Maximum Rating Table and Performance Curves in this data sheet.
3. For a definition of useful luminous flux ( $\Phi_{use}$ ), please see the ELR regulations at <https://tinyurl.com/4b6zvt4m>.
4. EPREL requires an arrow symbol containing the letter of the energy efficiency class to be displayed, on technical promotional material. Refer to this energy efficiency class column for specific energy efficiency class on each part number.

# Performance at Commonly Used Drive Currents

V Series HD LED arrays are tested to the specifications shown using the nominal drive currents in Table 1. V Series HD LED arrays may also be driven at other drive currents dependent on specific application design requirements. The performance at any drive current can be derived from the current vs. voltage characteristics shown in Figure 1 and the flux vs. current characteristics shown in Figure 2. The performance at commonly used drive currents is summarized in Table 3.

**Table 4:** Product Performance at Commonly Used Drive Currents

Part Number	CRI	Drive Current <sup>1</sup> (mA)	Typical $V_f$ $T_c = 25^\circ\text{C}$ (V)	Typical Power $T_c = 25^\circ\text{C}$ (W)	Typical Flux <sup>2</sup> $T_c = 25^\circ\text{C}$ (lm)	Typical DC Flux <sup>3</sup> $T_c = 85^\circ\text{C}$ (lm)	Typical Efficacy $T_c = 25^\circ\text{C}$ (lm/W)
BXRH-27G30To-E-8x	90	200	30.3	6.1	983	909	162
		300	31.1	9.3	1441	1330	155
		500	32.5	16.3	2309	2112	142
		<b>700</b>	<b>33.9</b>	<b>23.7</b>	<b>3110</b>	<b>2799</b>	<b>131</b>
		900	35.1	31.6	3845	3454	122
		1000	35.6	35.6	4187	3738	118
BXRH-27G30TB-E-8x	90	200	30.3	6.1	983	909	162
		300	31.1	9.3	1441	1330	155
		500	32.5	16.3	2309	2112	142
		<b>700</b>	<b>33.9</b>	<b>23.7</b>	<b>3110</b>	<b>2799</b>	<b>131</b>
		900	35.1	31.6	3845	3454	122
		1000	35.6	35.6	4187	3738	118
BXRH-30G30To-E-8x	90	200	30.3	6.1	1024	947	169
		300	31.1	9.3	1502	1385	161
		500	32.5	16.3	2405	2201	148
		<b>700</b>	<b>33.9</b>	<b>23.7</b>	<b>3240</b>	<b>2916</b>	<b>137</b>
		900	35.1	31.6	4005	3599	127
		1000	35.6	35.6	4362	3895	122
BXRH-30G30TB-E-8x	90	200	30.3	6.1	998	924	165
		300	31.1	9.3	1464	1351	157
		500	32.5	16.3	2345	2146	144
		<b>700</b>	<b>33.9</b>	<b>23.7</b>	<b>3159</b>	<b>2843</b>	<b>133</b>
		900	35.1	31.6	3905	3509	124
		1000	35.6	35.6	4253	3797	119
BXRH-35G30To-E-8x	90	200	30.3	6.1	1034	957	171
		300	31.1	9.3	1517	1399	163
		500	32.5	16.3	2429	2222	149
		<b>700</b>	<b>33.9</b>	<b>23.7</b>	<b>3272</b>	<b>2945</b>	<b>138</b>
		900	35.1	31.6	4045	3634	128
		1000	35.6	35.6	4405	3933	124
BXRH-35G30TB-E-8x	90	200	30.3	6.1	1018	942	168
		300	31.1	9.3	1493	1378	160
		500	32.5	16.3	2392	2188	147
		<b>700</b>	<b>33.9</b>	<b>23.7</b>	<b>3222</b>	<b>2900</b>	<b>136</b>
		900	35.1	31.6	3983	3579	126
		1000	35.6	35.6	4338	3873	122



# Performance at Commonly Used Drive Currents

**Table 4:** Product Performance at Commonly Used Drive Currents

Part Number	CRI	Drive Current <sup>1</sup> (mA)	Typical $V_f$ $T_c = 25^\circ\text{C}$ (V)	Typical Power $T_c = 25^\circ\text{C}$ (W)	Typical Flux <sup>2</sup> $T_c = 25^\circ\text{C}$ (lm)	Typical DC Flux <sup>3</sup> $T_c = 85^\circ\text{C}$ (lm)	Typical Efficacy $T_c = 25^\circ\text{C}$ (lm/W)
BXRH-40G30To-E-8x	90	200	30.3	6.1	1062	983	175
		300	31.1	9.3	1558	1437	167
		500	32.5	16.3	2495	2283	153
		<b>700</b>	<b>33.9</b>	<b>23.7</b>	<b>3361</b>	<b>3025</b>	<b>142</b>
		900	35.1	31.6	4155	3733	132
		1000	35.6	35.6	4525	4040	127
BXRH-40G30TB-E-8x	90	200	30.3	6.1	1053	974	174
		300	31.1	9.3	1544	1425	166
		500	32.5	16.3	2474	2263	152
		<b>700</b>	<b>33.9</b>	<b>23.7</b>	<b>3332</b>	<b>2999</b>	<b>141</b>
		900	35.1	31.6	4119	3701	131
		1000	35.6	35.6	4486	4005	126

Notes for Table 4:

1. Alternate drive currents are provided for reference only and are not a guarantee of performance.
2. Bridgelux maintains a  $\pm 7\%$  tolerance on flux measurements.
3. Typical stabilized DC performance values are provided as reference only and are not a guarantee of performance.

# Electrical Characteristics

**Table 5:** Electrical Characteristics

Part Number	Drive Current (mA)	Forward Voltage Pulsed, $T_c = 25^\circ\text{C}$ (V) <sup>1, 2, 3, 8</sup>			Typical Coefficient of Forward Voltage <sup>4</sup> $\Delta V_f / \Delta T_c$ (mV/ $^\circ\text{C}$ )	Typical Thermal Resistance Junction to Case <sup>5,6</sup> $R_{j-c}$ ( $^\circ\text{C}/\text{W}$ )	Driver Selection Voltages <sup>7</sup> (V)	
		Minimum	Typical	Maximum			$V_f$ Min. Hot $T_c = 105^\circ\text{C}$ (V)	$V_f$ Max. Cold $T_c = -40^\circ\text{C}$ (V)
BXRH-xxx30xx-E-8x	700	31.8	33.9	35.9	-10.8	0.55	31.1	36.6

Notes for Table 5:

- Parts are tested in pulsed conditions.  $T_c = 25^\circ\text{C}$ . Pulse width is 10ms.
- Voltage minimum and maximum are provided for reference only and are not a guarantee of performance.
- Bridgelux maintains a tester tolerance of  $\pm 0.10\text{V}$  on forward voltage measurements.
- Typical coefficient of forward voltage tolerance is  $\pm 0.1\text{mV}$  for nominal current.
- Thermal resistance values are based from test data of a 3000K 90 CRI product.
- Thermal resistance value was calculated using total electrical input power; optical power was not subtracted from input power. The thermal interface material used during testing is not included in the thermal resistance value.
- $V_f$  min hot and max cold values are provided as reference only and are not guaranteed by test. These values are provided to aid in driver design and selection over the operating range of the product.
- This product has been designed and manufactured per IEC 62031:2018. This product has passed dielectric withstand voltage testing at 500 V. The working voltage designated for the insulation is 50V d.c. The maximum allowable voltage across the array must be determined in the end product application.

# Eye Safety

**Table 6:** Eye Safety Risk Group (RG) Classifications

Part Number	Drive Current (mA)	CCT <sup>1,3</sup>	
		2700K/3000K <sup>2</sup>	4000K <sup>3</sup>
BXRH-xxx30xx-E-8x	700	RG1	RG2
	1000	RG2	RG2

Notes for Table 6:

1. Eye safety classification for the use of Bridgelux V Series HD LED arrays is in accordance with specification IEC/TR 62778: Application of IEC 62471 for the assessment of blue light hazard to light sources and luminaires.
2. For products classified as RG2 at 3000K,  $E_{thr} = 2670$  lx.
3. For products classified as RG2 at 4000K,  $E_{thr} = 1760$  lx.
4. Please contact your Bridgelux sales representative for  $E_{thr}$  values at specific drive currents and CCTs not listed.

# Absolute Maximum Ratings

**Table 7:** Maximum Ratings

Parameter	Maximum Rating
LED Junction Temperature (T <sub>j</sub> )	125°C
Storage Temperature <sup>1</sup>	-40°C to +85°C
Operating Case Temperature <sup>2</sup> (T <sub>c</sub> )	85°C
Soldering Temperature <sup>3</sup>	350°C or lower for a maximum of 6 seconds
	BXRH-xxx30xx-E-8x
Maximum Drive Current <sup>4</sup>	1000mA
Maximum Peak Pulsed Drive Current <sup>5</sup>	1200 mA
Maximum Reverse Voltage	-60V

Notes for Table 7:

1. The F90 product is robust enough to pass our internal humidity test but it is still more sensitive compared to regular LED array product. The product needs to be stored in a dry environment. It is not recommended to use the product in a damp environment that directly exposes it to moisture.
2. For IEC 62717 requirement, please consult your Bridgelux sales representative.
3. Refer to Bridgelux Application Note AN101: Handling and Assembly of Bridgelux V Series LED Arrays
4. Arrays may be driven at higher currents however lumen maintenance may be reduced and warranty will not apply.
5. Bridgelux recommends a maximum duty cycle of 10% and pulse width of 20 ms when operating LED Arrays at maximum peak pulsed current specified. Maximum peak pulsed currents indicate values where LED Arrays can be driven without catastrophic failures.

# Performance Curves

**Figure 1: VgE HD Drive Current vs. Voltage ( $T_j = T_c = 25^\circ\text{C}$ )<sup>1</sup>**

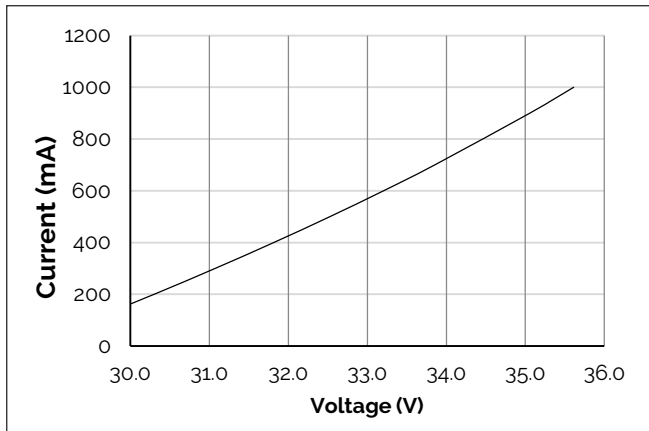

**Figure 2: VgE HD Typical Relative Flux vs. Drive Current ( $T_j = T_c = 25^\circ\text{C}$ )<sup>1</sup>**

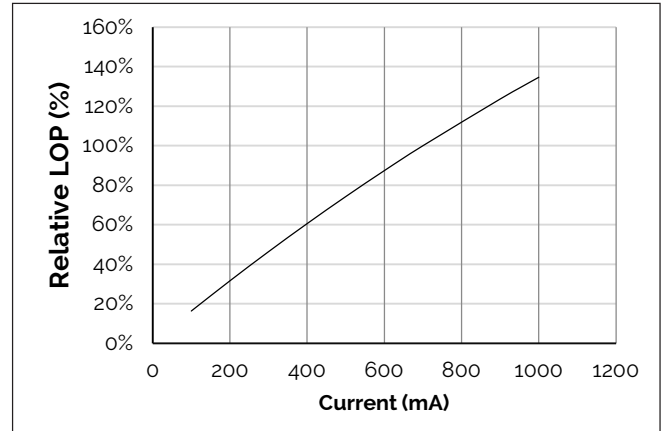

**Figure 3: Typical DC Flux vs. Case Temperature**

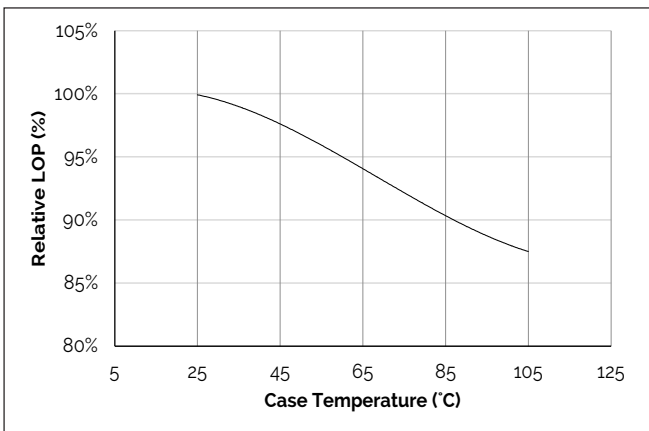

**Figure 4: Typical DC ccx Shift vs. Case Temperature**

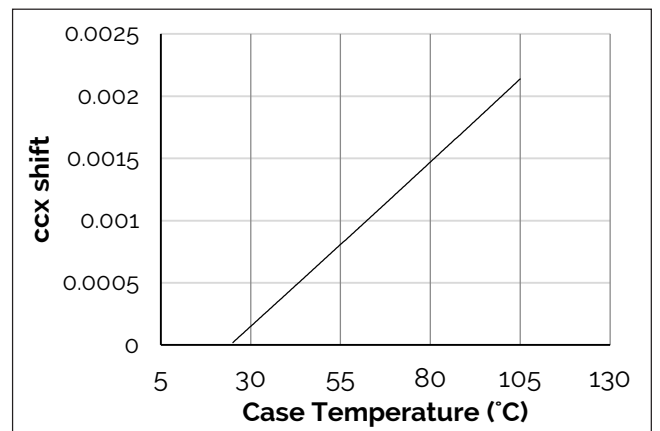

**Figure 5: Typical DC ccy Shift vs. Case Temperature**

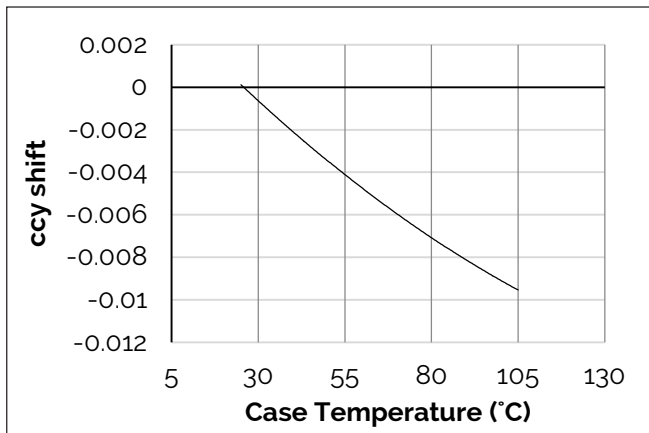

**Figure 6: VgE HD Drive Current vs. ccx Shift**

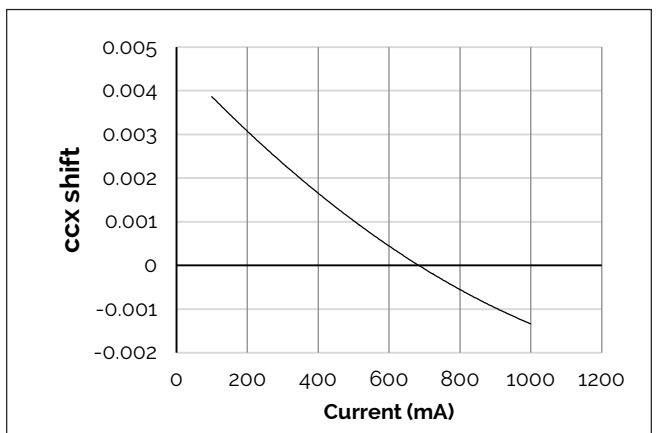

Notes for Figures 1 - 6:

1. Bridgelux does not recommend driving high power LEDs at low currents. Doing so may produce unpredictable results. Pulse width modulation (PWM) is recommended for dimming effects.
2. Characteristics shown for 3000K and 90 CRI.

# Performance Curves

Figure 7: VgE HD Drive Current vs. ccy Shift

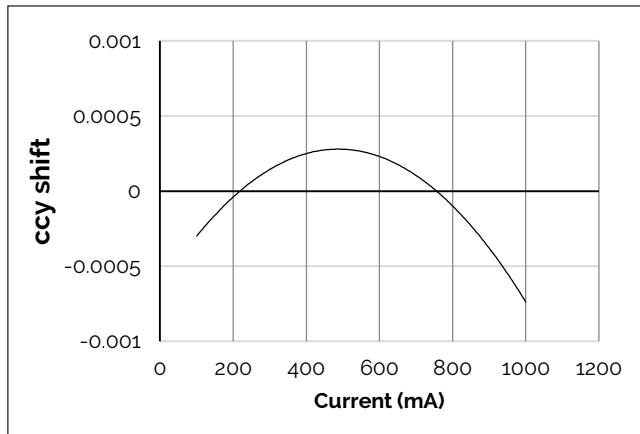

Notes for Figure 7:

1. Bridgelux does not recommend driving high power LEDs at low currents. Doing so may produce unpredictable results. Pulse width modulation (PWM) is recommended for dimming effects.
2. Characteristics shown for 3000K and 90 CRI.

# Typical Radiation Pattern

**Figure 8: Typical Spatial Radiation Pattern**

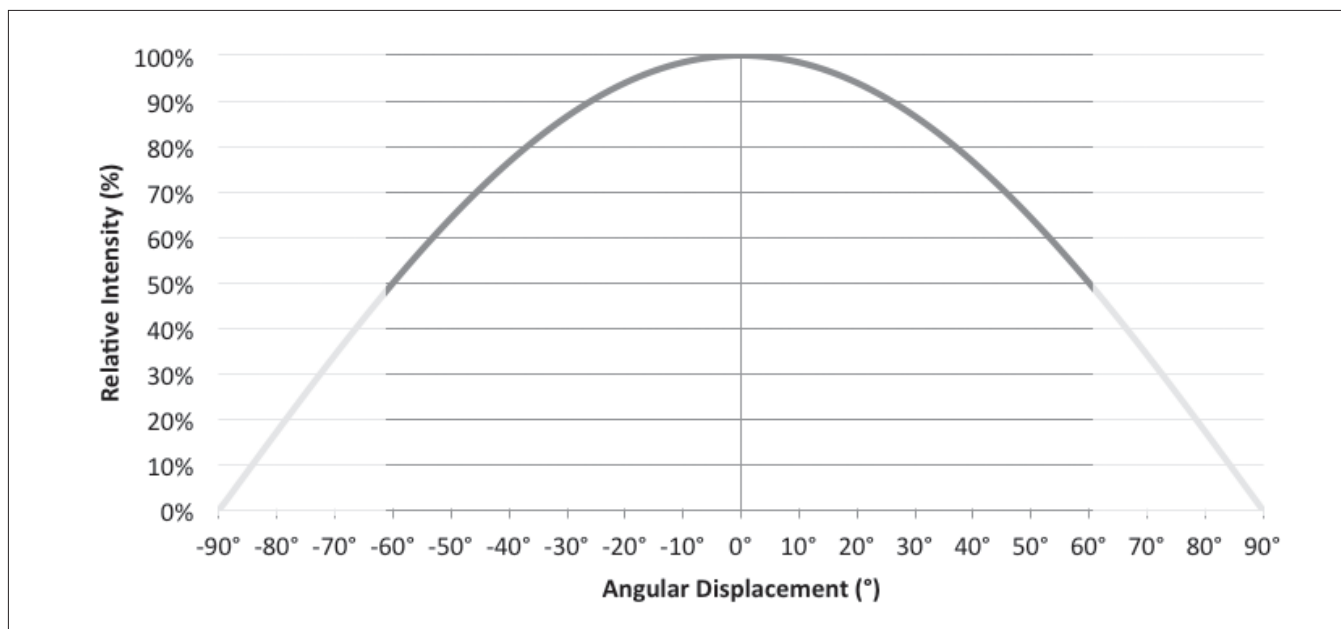

Notes for Figure 8:

1. Typical viewing angle is 120°.
2. The viewing angle is defined as the off axis angle from the centerline where intensity is ½ of the peak value.

**Figure 9: Typical Polar Radiation Pattern**

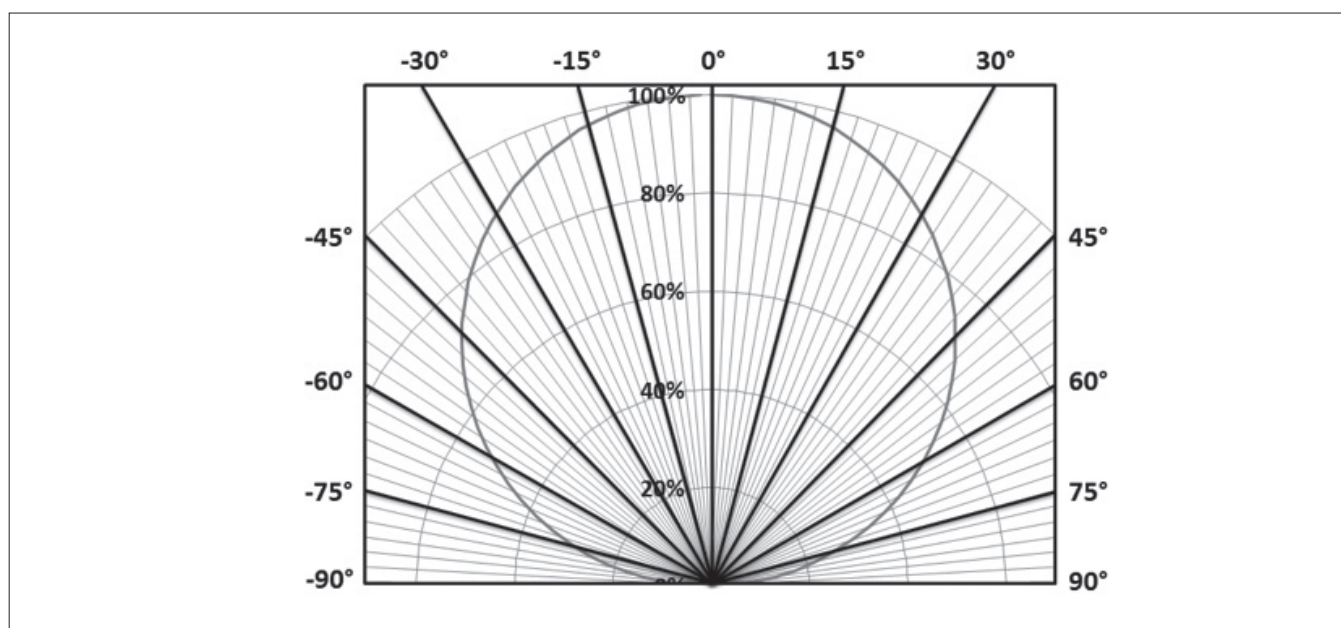

# Typical Color Spectrum

Figure 10: Typical Color Spectrum

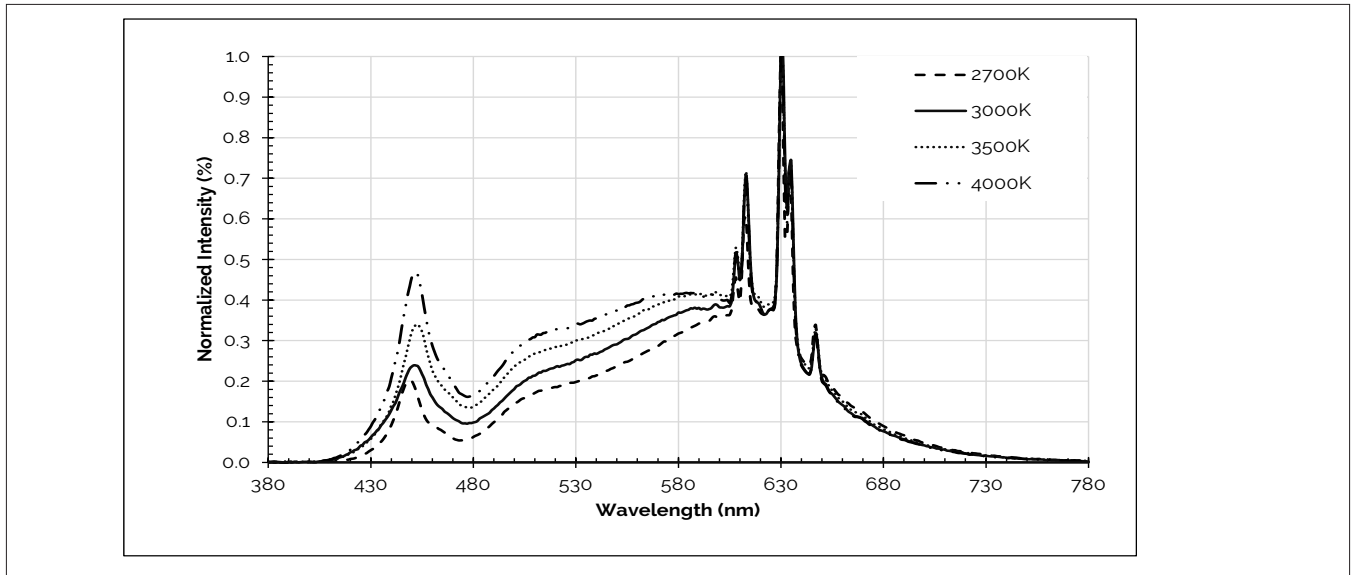

Notes for Figure 10:

1. Color spectra measured at nominal current for  $T_j = T_c = 85^\circ\text{C}$ .
2. Color spectra shown is 2700K and 90 CRI.
3. Color spectra shown is 3000K and 90 CRI.
4. Color spectra shown is 3500K and 90 CRI.
5. Color spectra shown is 4000K and 90 CRI.



# Mechanical Dimensions

**Figure 11: Drawing for Vg HD LED Array**

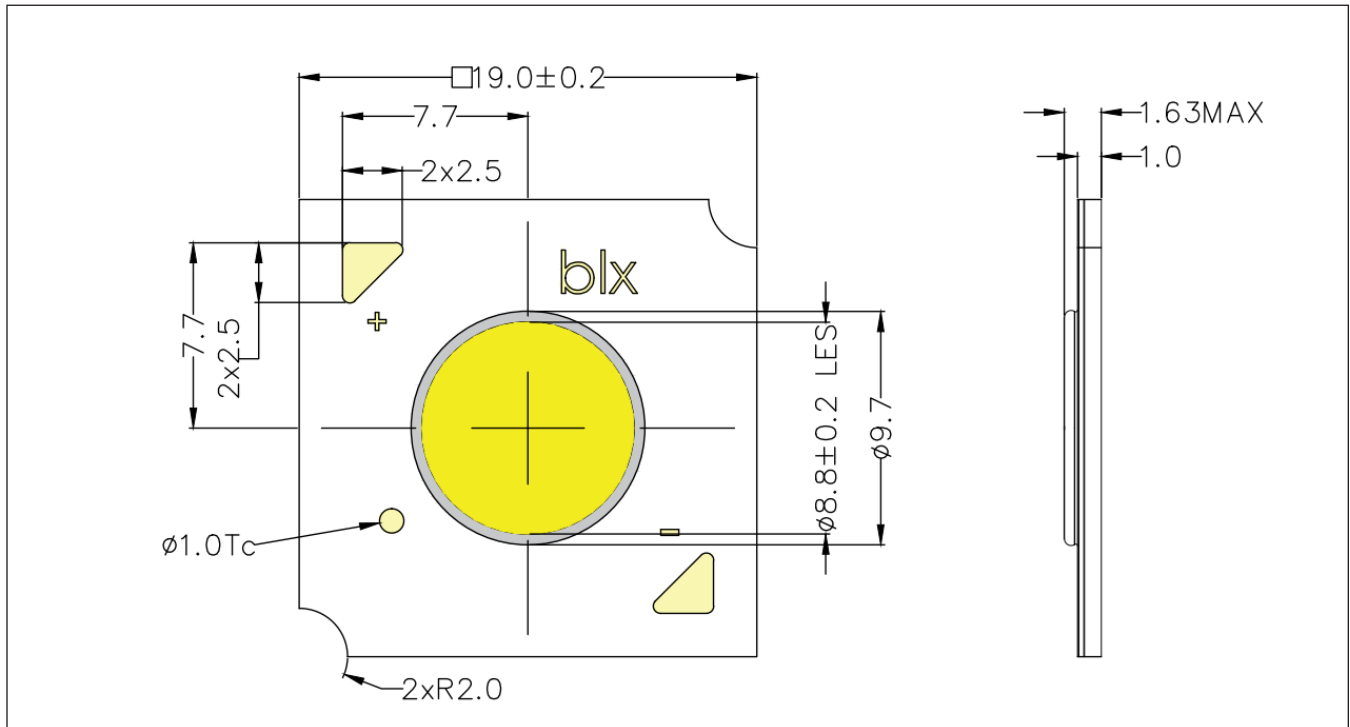

Notes for Figure 11:

1. Drawings are not to scale.
2. Drawing dimensions are in millimeters.
3. Solder pads are labeled "+" and "-" to denote positive and negative polarity, respectively.
4. Unless otherwise specified, tolerances are  $\pm 0.1$ mm.
5. Refer to Application Notes AN101 for product handling, mounting and heat sink recommendations.
6. The optical center of the LED Array is nominally defined by the mechanical center of the array to a tolerance of  $\pm 0.2$ mm.
7. Bridgelux maintains a flatness of  $0.10$ mm across the mounting surface of the array.

# Color Binning Information

**Figure 12: Warm and Neutral White Test Bins in xy Color Space**

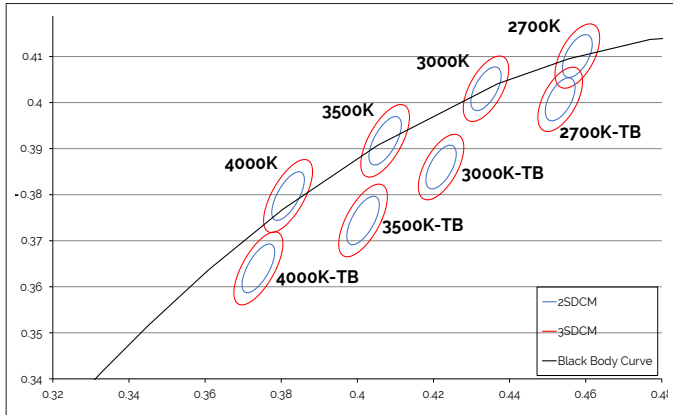

Note: Pulsed Test Conditions.  $T_c = 85^\circ\text{C}$

**Table 8: Warm and Neutral White xy Bin Coordinates and Associated Typical CCT**

Bin Code	2700K	2700K-TB	3000K	3000K-TB	3500K	3500K-TB	4000K	4000K-TB
ANSI Bin (for reference only)	(2580K - 2870K)	N/A	(2870K - 3220K)	N/A	(3220K - 3710K)	N/A	(3710K - 4260K)	N/A
83 (3 SDCM)	(2651K - 2794K)	(2645K - 2788K)	(2968K - 3136K)	(3025K - 3210K)	(3369K - 3586K)	(3333K - 3566K)	(3851K - 4130K)	(3936K - 4254K)
82 (2 SDCM)	(2674K - 2769K)	(2668K - 2764K)	(2995K - 3107K)	(3055K - 3178K)	(3404K - 3548K)	(3370K - 3526K)	(3895K - 4081K)	(3985K - 4197K)
Center Point (x,y)	(0.4578, 0.4101)	(0.4533, 0.4007)	(0.4338, 0.403)	(0.4220, 0.3860)	(0.4073, 0.3917)	(0.4015, 0.3744)	(0.3818, 0.3797)	(0.3740, 0.3640)

Note for Table 8:

1. Bridgelux maintains a tolerance of +/- 0.007 on x and y color coordinates in the CIE 1931 color Space.

# Packaging and Labeling

Figure 13: Vg HD Packaging Tube

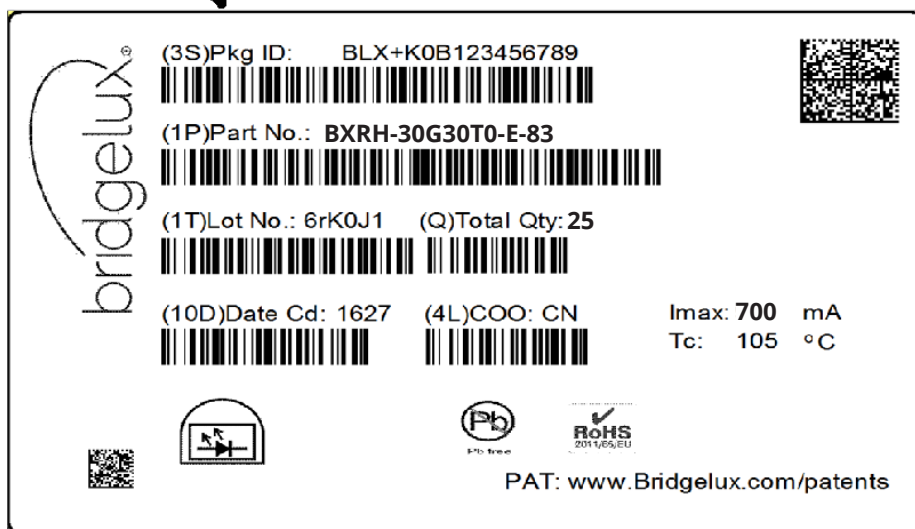

Box Label

Commercial Invoice  
and Packing list



Notes for Figure 13:

1. Each tube holds 25 VgHD COB arrays.
2. One tube is sealed in an anti-static bag. Four bags are placed in a shipping box. Depending on quantities ordered, a bigger shipping box, containing four boxes may be used to ship products.
3. Each bag and box is to be labeled as shown above.
4. Dimensions for each tube are 15.4 (W) x 8.3 (H) x 430 (L) mm. Dimensions for the anti-static bag are 75 (W) x 615 (L) x 0.075 (T) mm. Dimensions for the shipping box are 58.7 x 13.3 x 7.9 cm

# Packaging and Labeling

**Figure 14: V Series HD Product Labeling**

Bridgelux COB arrays have laser markings on the back side of the substrate to help with product identification. In addition to the product identification markings, Bridgelux COB arrays also contain markings for internal Bridgelux manufacturing use only. The image below shows which markings are for customer use and which ones are for Bridgelux internal use only. The Bridgelux internal manufacturing markings are subject to change without notice, however these will not impact the form, function or performance of the COB array.



# Design Resources

## Application Notes

Bridgelux has developed a comprehensive set of application notes and design resources to assist customers in successfully designing with the V Series product family of LED array products. For all available application notes visit [www.bridgelux.com](http://www.bridgelux.com).

## Optical Source Models

Optical source models and ray set files are available for all Bridgelux products. For a list of available formats, visit [www.bridgelux.com](http://www.bridgelux.com).

## 3D CAD Models

Three dimensional CAD models depicting the product outline of all Bridgelux V Series HD LED arrays are available in both IGS and STEP formats. Please contact your Bridgelux sales representative for assistance.

## LM80

LM80 testing has been completed and the LM80 report is now available. Please contact your Bridgelux sales representatives for LM-80 report.

# Precautions

## CAUTION: CHEMICAL EXPOSURE HAZARD

Exposure to some chemicals commonly used in luminaire manufacturing and assembly can cause damage to the LED array. Please consult Bridgelux Application Note AN101 for additional information.

## CAUTION: RISK OF BURN

Do not touch the V Series HD LED array during operation. Allow the array to cool for a sufficient period of time before handling. The V Series HD LED array may reach elevated temperatures such that could burn skin when touched.

## CAUTION

### CONTACT WITH LIGHT EMITTING SURFACE (LES)

Avoid any contact with the LES. Do not touch the LES of the LED array or apply stress to the LES (yellow phosphor resin area). Contact may cause damage to the LED array.

Optics and reflectors must not be mounted in contact with the LES (yellow phosphor resin area).

# Disclaimers

## MINOR PRODUCT CHANGE POLICY

The rigorous qualification testing on products offered by Bridgelux provides performance assurance. Slight cosmetic changes that do not affect form, fit, or function may occur as Bridgelux continues product optimization.

## STANDARD TEST CONDITIONS

Unless otherwise stated, array testing is performed at the nominal drive current.

# About Bridgelux: Bridging Light and Life™

At Bridgelux, we help companies, industries and people experience the power and possibility of light. Since 2002, we've designed LED solutions that are high performing, energy efficient, cost effective and easy to integrate. Our focus is on light's impact on human behavior, delivering products that create better environments, experiences and returns—both experiential and financial. And our patented technology drives new platforms for commercial and industrial luminaires.

**For more information about the company, please visit**  
**[bridgelux.com](http://bridgelux.com)**  
**[twitter.com/Bridgelux](https://twitter.com/Bridgelux)**  
**[facebook.com/Bridgelux](https://facebook.com/Bridgelux)**  
**[youtube.com/user/Bridgelux](https://youtube.com/user/Bridgelux)**  
**[linkedin.com/company/bridgelux-inc-\\_2](https://linkedin.com/company/bridgelux-inc-_2)**  
**WeChat ID: BridgeluxInChina**



46410 Fremont Boulevard  
Fremont, CA 94538 U.S.A.  
Tel (925) 583-8400  
**[www.bridgelux.com](http://www.bridgelux.com)**

© 2024 Bridgelux, Inc. All rights reserved. Product specifications are subject to change without notice. Bridgelux, the Bridgelux stylized logo design and Vero are registered trademarks. V Series and Decor Series are trademarks of Bridgelux, Inc. All other trademarks are the property of their respective owners.

**Bridgelux Gen 8 V9 HD F90 Array Series Product Data Sheet DS1362 Rev. A (03/2024)**