

# Bridgelux® Pallas-M Single Channel 24W (Multi-Dim) Brick Driver

Product Data Sheet DS1225

# Product Feature Map

Bridgelux Pallas-M (Multi-Dim) Single Channel 24W Driver provides dynamic constant current output for LED modules and arrays. This Driver interoperates with Phase-Cut (Leading-edge / Trailing-edge) and 0-10V dimming protocol, plus come with Universal Inputs (120/277V), which allows for simple integration of Bridgelux's and all major brands White Arrays and Linear modules. Please visit [www.bridgelux.com](http://www.bridgelux.com) for more information.

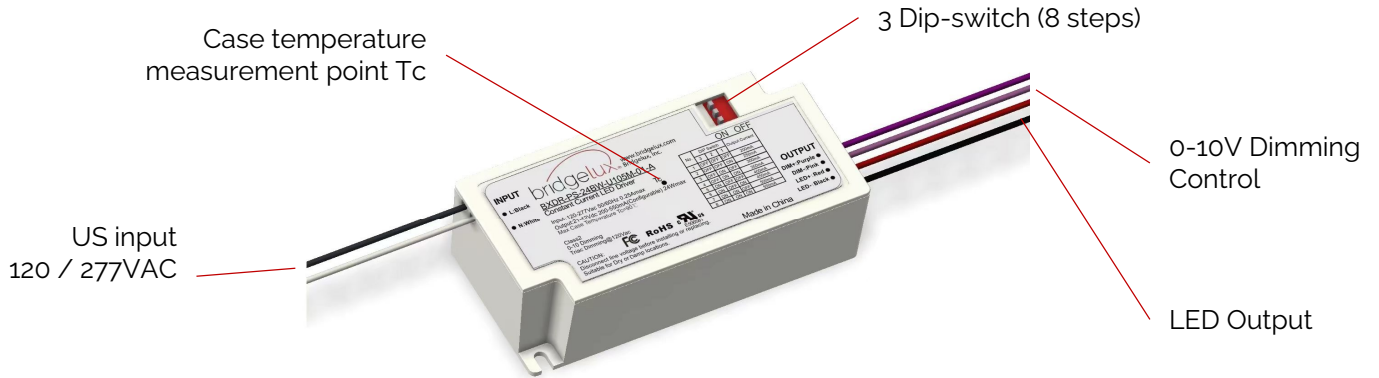

## Product Nomenclature

The part number designation for Bridgelux Pallas-M (Multi-Dim) Single Channel 24W Driver is explained as follows:

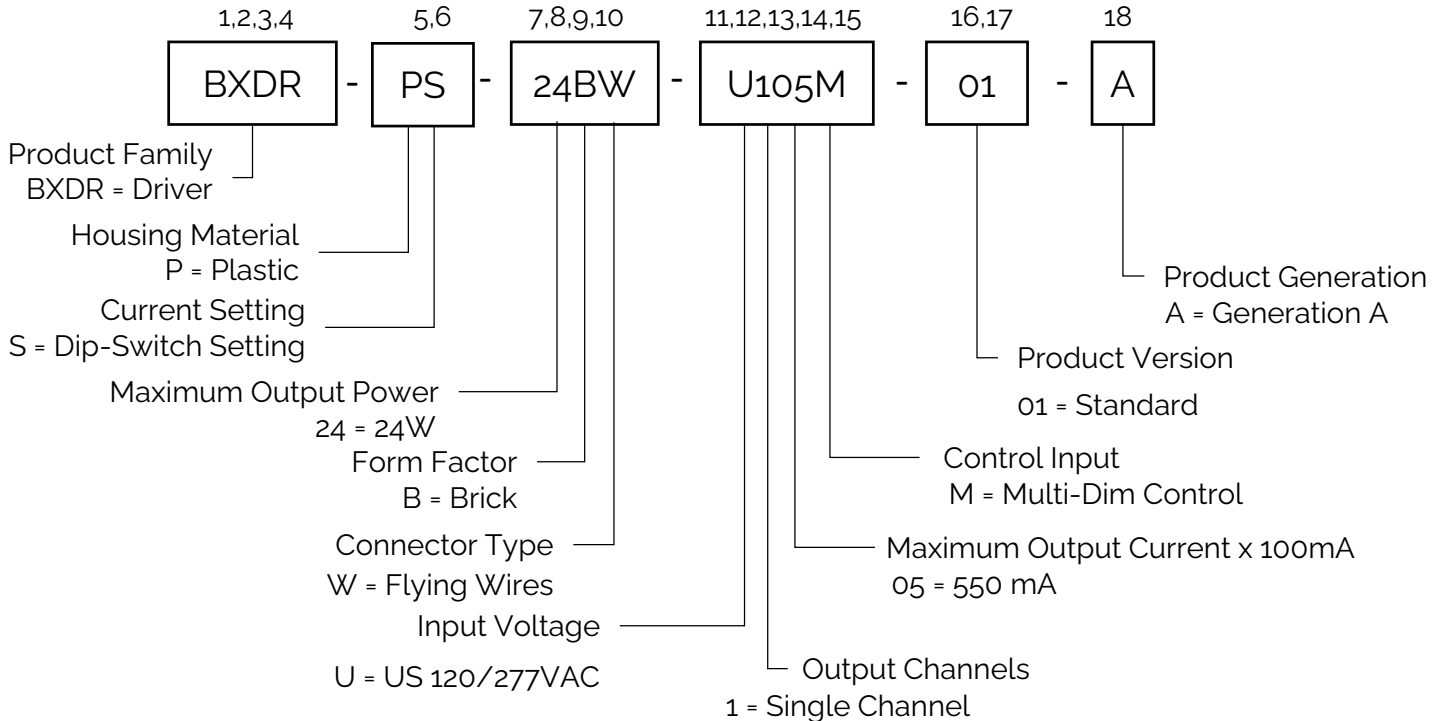

Table 1: Product Selection Guide

Part Number	Configuration
BXDR-PS-24BW-U105M-01-A	Brick with Flying Wires

# Electrical Characteristics

Table 2: Input Electrical Characteristics

Parameter	Unit	Specification
Nominal voltage	V	120 / 277 VAC
Nominal frequency	Hz	50 / 60 Hz
AC voltage range	V	108 – 305 VAC
Input current (max)	A	< 0.25 A (@ 120V) < 0.11 A (@ 277V)
THD (Full load)	%	< 20% (@ 120V) < 20% (@ 277V)
Power factor (Full load)	-	> 0.9 (@ 120V) > 0.9 (@ 277V)
Efficiency (Full load)	%	> 85% (@ 120V) > 82% (@ 277V)
NO load	W	≤ 0.5 W
Start-up Time	s	< 0.5 s

Table 3: Output Electrical Characteristics

Parameter	Unit	Specification							
Nominal voltage range	V	21-42V	21-42V	21-42V	21-42V	21-42V	21-42V	21-42V	21-42V
Maximum voltage(Open Circuit)	Vdc	≤ 59							
Nominal current	mA	200	250	300	350	400	450	500	550
Current accuracy	%	+/- 5							
Current ripple LF < 3KHz	%	≤ 10							
Pst LM	-	≤ 1							
SVM	-	≤ 0.4							
Maximum power	W	24							
Galvanic isolation:	-	SELV							
<b>SELV</b>	-								

# Dimming Characteristics

Table 4: Phase-Cut Dimming Control Characteristics

Parameter	Unit	Specification
Compatible Phase-Cut Dimming	-	Leading-edge Trailing-edge
Support Input Voltage		120Vac
Output Current Range	-	10 mA (min) to Current Setting (max)
Suggested Load Range	V	7 – 24W

Table 5: Compatible Phase-Cut Dimmer (120Vac only)

No.	Mfg.	Model	Remark	No.	Mfg.	Model	Remark
1	Lutron	MACL-153M		12	Leviton	1B34L1	
2	Lutron	LGCL-153PL		13	Leviton	IPL06	
3	Lutron	GLU12-F23622		14	Leviton	SureSlide 6633	
4	Leviton	111506		15	Leviton	IPE04	
5	Lutron	GLV-600		16	Leviton	IPL06-102	
6	Lutron	D-600P		17	Lutron	DVCL-153P	
7	Lutron	DVLV-600P		18	Legrand	LSLV603	
8	Lutron	MALV-600	Po>20W	19	Legrand	RHCL453P	
9	Lutron	NT-1000	Po>20W	20	Lutron	1K35O2	
10	Lutron	SLV-600P		21	Lutron	DV-600P	
11	Lutron	MA-600	Po>20W				

Table 6: 0-10V / 1-10V Dimming Control Characteristics

Parameter	Unit	Specification
Dim+, Dim-	-	The 0~10V or resistor dimming can be used to dim the output current via a standard commercial wall dimmer (0~10VDC) or an external control voltage source (0~10VDC) or external resistor.
Dimming Curve	-	Linear
Source Current on 0~10V Dimming Pin	-	50 – 150 $\mu$ A
Dimming Voltage for Full Bright	V	> 8V
Output Current Range		1 – 100%
External Resistor Value at Full Bright	$\Omega$	45 k $\Omega$

# Electrical Characteristics

Figure 1: Power Factor vs. Load

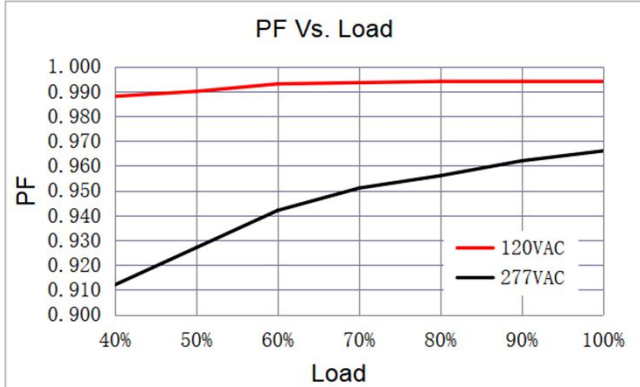

Figure 2: Total Harmonic Distortion vs. Load

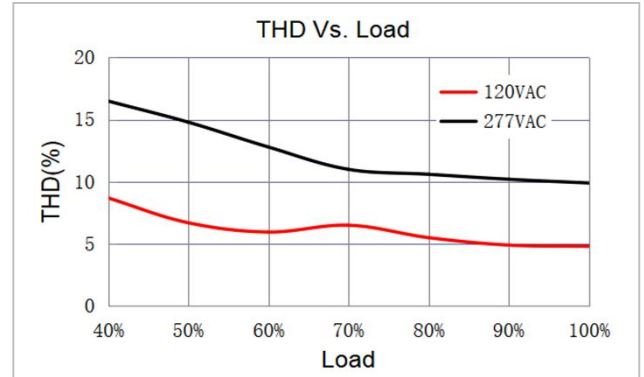

Figure 3: Efficiency vs. Load

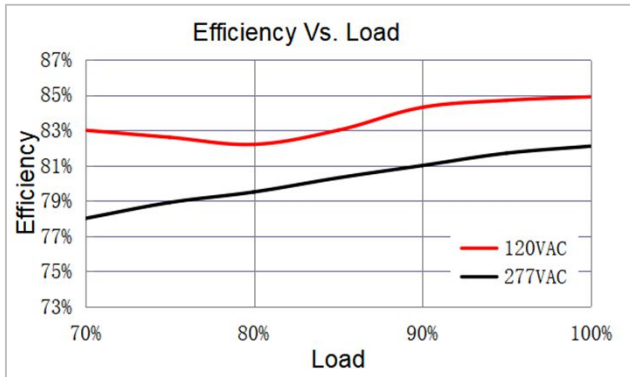

Figure 4: Expected Life Time

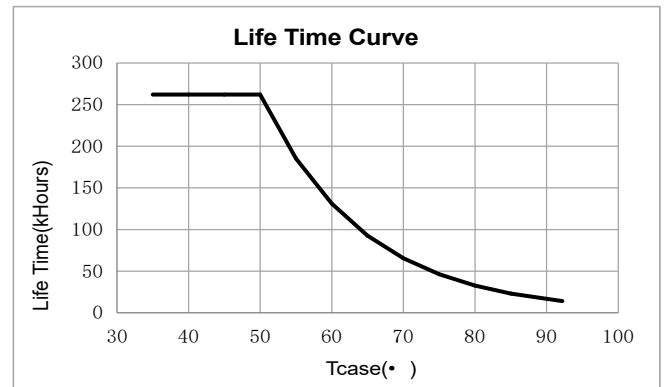

Figure 5: Operating Window

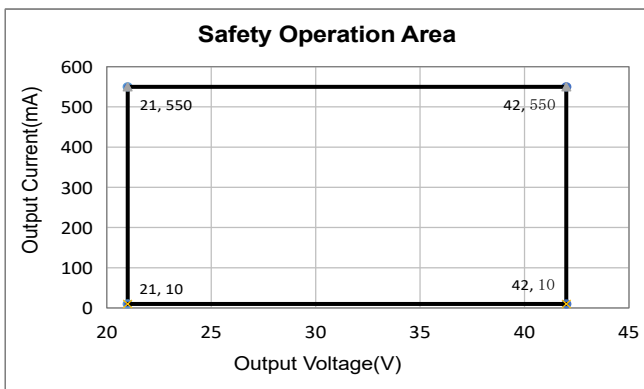
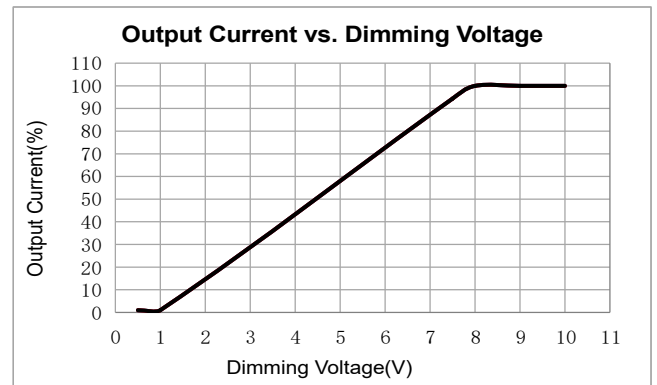

Figure 6: Output Current vs. Dimming Voltage



# Mechanical Characteristics

Table 7: Product Mechanical data

Characteristics	Specification
Dimensions	85.6 mm (L) x 41.6 mm (W) x 24.7 mm (H)
Enclosure Materials	PC Plastic
Weight	142 g
Ingress Protection	IP20

Figure 7: Mechanical Drawing

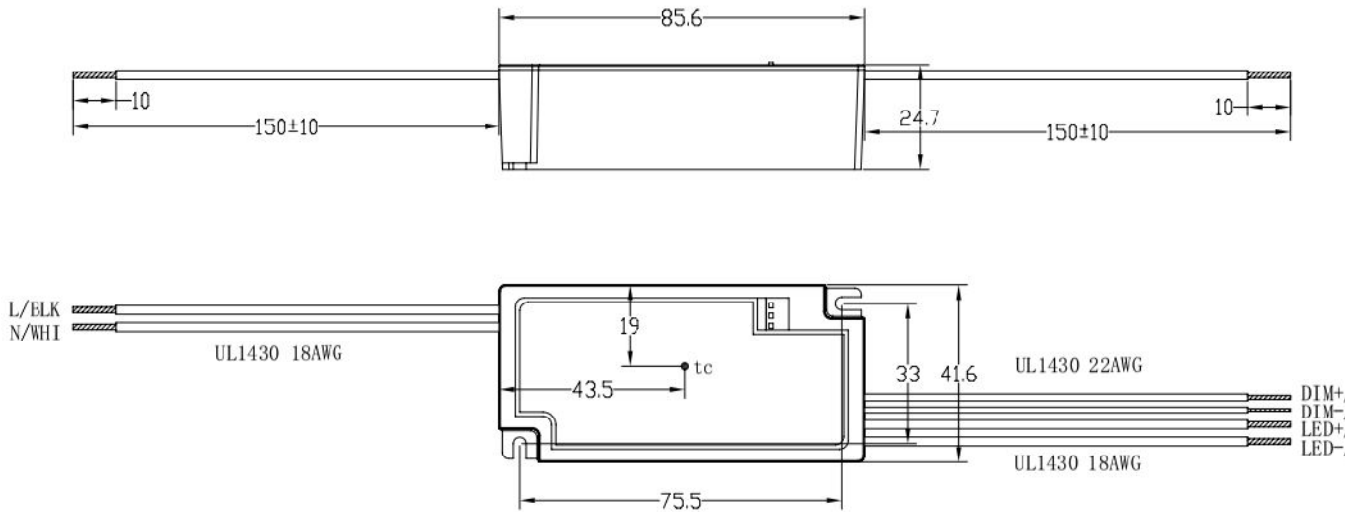

Notes for Figure 7:

1. Drawing dimensions are in millimeters
2. Unless otherwise specified, all linear tolerances are +/-1.0mm

# Wiring Diagram

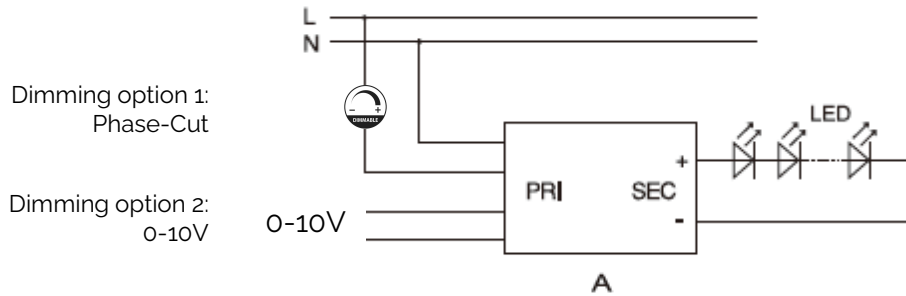

Table 8: **Wiring**

PRI		
PRI / SEC	Cable cross-section	0.75 mm <sup>2</sup> / AWG 18
	Cable Length	150 mm
0-10V Dim	Cable cross-section	0.35 mm <sup>2</sup> / AWG 22
	Cable Length	150 mm

Notes for Table 8:

- Hot plug-in or secondary switching of LEDs is not permitted and may cause a very high current to the LEDs.

# DIP-switch operation instructions & operating window

Table 9: **Dip-switch operation instructions & operating window**

Dip-switch setting			U <sub>out</sub>	I <sub>out</sub>
1	2	3		
OFF	OFF	OFF	21-42V	200 mA
OFF	OFF	ON	21-42V	250 mA
OFF	ON	OFF	21-42V	300 mA
OFF	ON	ON	21-42V	350 mA
ON	OFF	OFF	21-42V	400 mA
ON	OFF	ON	21-42V	450 mA
ON	ON	OFF	21-42V	500 mA
ON	ON	ON	21-42V	550 mA

# Environmental and Regulatory Standards

Table 10: Environmental Conditions

Parameter	Specification
Ambient Operating Temperature	-25°C to + 50°C
Max. Case Temperature Tc	+90°C (max)
Humidity Rating	Maximum 90% Relative Humidity, non condensing
Storage Temperature	-20°C to + 85°C
Expected Lifetime	50,000 hours (Tc < 70°C)

Table 11: Regulatory Approvals and Compliance

Specification	Reference Standard	Condition
Conducted and Radiated EMI	FCC Title 47 Part 15B	Class B at 120VAC, Class A at 277VAC
Voltage Fluctuations & Flicker	IEC 61000-3-3:2013+A1:2019	
ESD (Electrostatic Discharge)	IEC 61547:2009 Section 5.2 Test des.: IEC 61000-4-2	6 kV contact discharge, 8 kV air discharge, level 3
Electrical Fast Transient	IEC 61547 Section 5.5 Test des.: IEC 61000-4-4	± 2kV Direct couple to Line input, 5kHz repetition rate, 15mS duration, 300mS period. 7 coupling paths, 1 minute per path (14 total combinations)
Surge Protection	IEC 61547 Section 5.7 Test des.: IEC 61000-4-5 or ANSI/IEEE C62.41-2002	± 2kV Common and Differential Mode, test at 2 Ω, 5 strikes/1minute interval (40 total strikes)
	ANSI/IEEE C62.41.1-2002	2.5kV Ring Wave, test at 30Ω 7 Strikes/1 minute interval, Common and Differential mode, 56 total strikes
Voltage Dips	IEC 61547 Section 5.8, 5.9 Test des.: IEC 61000-4-11	>95% dip, .5 period; 30% dip, 25 periods; 95% reduction, 250 periods
Note: Unless otherwise specified, all the above parameters are measured at ambient temperature of 25°C and rated voltage.		



## Regulatory Standards (continued)

Table 12: Safety Agency Approvals

Specification	Reference Standard	Condition
UL / cUL	UL8750, CAN/CSA-C22.2 No. 250.13	UL Recognized, Class 2

Table 13: Protection

Specification	Specification
Output Over Voltage Protection (OVP)	> 50Vdc Yes / Auto Resume
Output Short-Circuit Protection (SCP)	Yes / Auto Resume



# Design Resources

## Application Notes

Please contact your Bridgelux sales representative for assistance on obtaining application support when designing with the Bridgelux Pallas-M Single Channel Driver. For a list of available resources, visit [www.bridgelux.com](http://www.bridgelux.com).

# Precautions

## CAUTION: PRODUCT HANDLING

Handle the Pallas-M Single Channel Driver with care to prevent any damage from mechanical shock. It is recommended to handle this driver in a static-free environment. Do not open or disassemble the product. To maintain product warranty, the installer is responsible for ensuring that the driver's operating conditions do not exceed the maximum conditions stated within this data sheet.

## CAUTION: PRODUCT INSTALLATION

Incorrect installation of the Pallas-M Single Channel Driver can cause irreparable damage to the driver, connected LEDs. Pay attention when connecting the LED load and observe the correct polarity of the output terminals as specified in this data sheet and on the driver label.

## CAUTION: ELECTRIC SHOCK

Be aware of the possibility of an electric shock hazard which can result in serious injury or death. Disconnect power before servicing or installing this device.

# Disclaimers

## MINOR PRODUCT CHANGE POLICY

The rigorous qualification testing on products offered by Bridgelux provides performance assurance. Slight cosmetic changes that do not affect form, fit, or function may occur as Bridgelux continues product optimization.

## About Bridgelux: Bridging Light and Life™

At Bridgelux, we help companies, industries and people experience the power and possibility of light. Since 2002, we've designed LED solutions that are high performing, energy efficient, cost effective and easy to integrate. Our focus is on light's impact on human behavior, delivering products that create better environments, experiences and returns—both experiential and financial. And our patented technology drives new platforms for commercial and industrial luminaires.

For more information about the company, please visit

[bridgelux.com](http://bridgelux.com)

[twitter.com/Bridgelux](https://twitter.com/Bridgelux)

[facebook.com/Bridgelux](https://facebook.com/Bridgelux)

[youtube.com/user/Bridgelux](https://youtube.com/user/Bridgelux)

[linkedin.com/company/bridgelux](https://linkedin.com/company/bridgelux)

WeChat ID: BridgeluxInChina



46410 Fremont Blvd

Fremont, CA 94538 USA

Tel (925) 583-8400

[www.bridgelux.com](http://www.bridgelux.com)