

# Bridgelux® EB Series™ Gen 3 F90 SE

Product Data Sheet DS141

Lengths: 140mm, 280mm, 560mm, 1120mm

CRI: 90

CCTs: 2700K, 3000K, 3500K, 4000K, 5000K



# Product Feature Map

Bridgelux EB Series Gen 3 modules are fully engineered devices that provide consistent thermal and optical performance on an engineered mechanical platform. The linear products incorporate several features to simplify design integration and assembly. Please visit [www.bridgelux.com](http://www.bridgelux.com) for more information on the EB Series family of products.

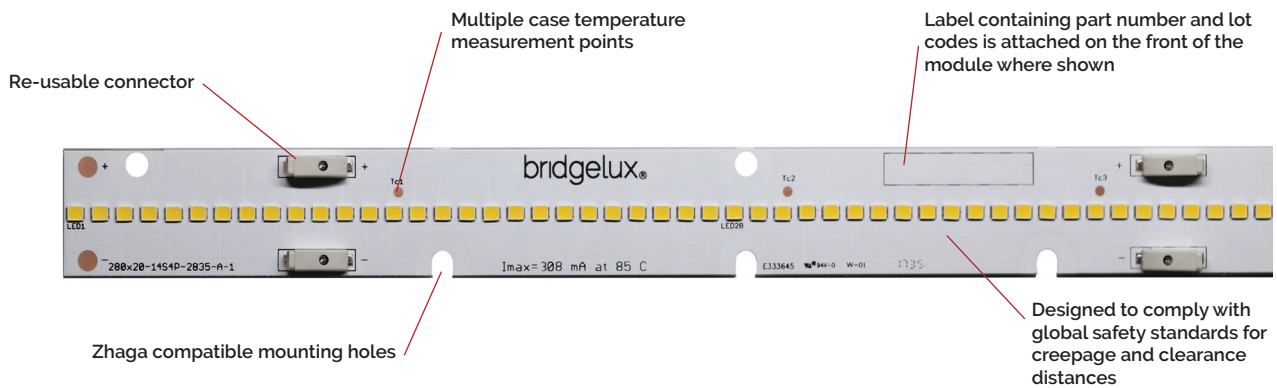

## Product Nomenclature

The part number designation for Bridgelux EB Series Gen 3 F90 is explained as follows:

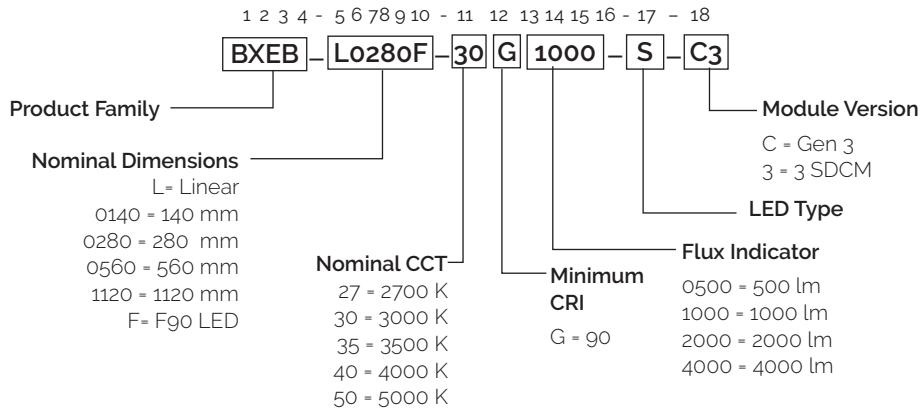

# Product Selection Guide

**Table 1: Product Performance ( $T_c = 25^\circ \text{C}$ )**

Part Number	Nominal CCT <sup>1</sup> (K)	CRI	Typical Flux <sup>2,3</sup> $T_c = 25^\circ \text{C}$ (lm)	Nominal Drive Current (mA)	Typical $V_f$ (V)	Typical Power (W)	Typical Efficacy (lm/W)
BXEB-L0140F-27G0500-S-C3	2700	90	495	77	38.5	3.0	165
BXEB-L0140F-30G0500-S-C3	3000	90	501				167
BXEB-L0140F-35G0500-S-C3	3500	90	504				168
BXEB-L0140F-40G0500-S-C3	4000	90	516				172
BXEB-L0140F-50G0500-S-C3	5000	90	516				172
BXEB-L0280F-27G1000-S-C3	2700	90	990	154		6.0	165
BXEB-L0280F-30G1000-S-C3	3000	90	1002				167
BXEB-L0280F-35G1000-S-C3	3500	90	1008				168
BXEB-L0280F-40G1000-S-C3	4000	90	1032				172
BXEB-L0280F-50G1000-S-C3	5000	90	1032				172
BXEB-L0560F-27G2000-S-C3	2700	90	1964	308		11.9	165
BXEB-L0560F-30G2000-S-C3	3000	90	1987				167
BXEB-L0560F-35G2000-S-C3	3500	90	1999				168
BXEB-L0560F-40G2000-S-C3	4000	90	2047				172
BXEB-L0560F-50G2000-S-C3	5000	90	2047				172
BXEB-L1120F-27G4000-S-C3	2700	90	3927	616		23.8	165
BXEB-L1120F-30G4000-S-C3	3000	90	3975				167
BXEB-L1120F-35G4000-S-C3	3500	90	3998				168
BXEB-L1120F-40G4000-S-C3	4000	90	4093				172
BXEB-L1120F-50G4000-S-C3	5000	90	4093				172

Notes for Table 1:

1. Nominal CCT as defined by ANSI C78.377-2011.
2. Data is at nominal test current where temperature of center case temperature point  $T_c = 25^\circ \text{C}$ .
3. Bridgelux maintains a  $\pm 7\%$  tolerance on flux data.

# Electrical Characteristics

**Table 2: Electrical Characteristics**

Part Number	Drive Current (mA)	Forward Voltage $T_{c2} = 25^{\circ} \text{C (V)}^{1,2,3}$		
		Minimum	Typical	Maximum
BXEB-L0140F-xxx0500-S-C3	77	38.0	38.5	39.0
BXEB-L0280F-xxx1000-S-C3	154	38.0	38.5	39.0
BXEB-L0560F-xxx2000-S-C3	308	38.0	38.5	39.0
BXEB-L1120F-xxx4000-S-C3	616	38.0	38.5	39.0

Notes for Table 2:

1. Voltage minimum and maximum are provided for reference only and are not a guarantee of performance.
2. Bridgelux maintains a tolerance of  $\pm 0.1 \text{ V}$  on forward voltage data.
3. This product has been designed and manufactured per IEC 62031:2018. The working voltage designated for the insulation is 60 V d.c. The maximum allowable voltage across the module must be determined in the end product application.

# Absolute Maximum Ratings

**Table 3: Maximum Ratings**

Parameter	Maximum Rating			
Storage Temperature	-40°C to +85°C			
Operating Case Temperature <sup>2</sup> (T <sub>c</sub> )	85°C			
Soldering Temperature	350°C or lower for a maximum of 5 seconds			
Maximum Reverse Voltage	Modules are not designed to be driven in reverse bias			
	BXEB-L0140F- xxx0500-S-C3	BXEB-L0280F- xxx1000-S-C3	BXEB-L0560F- xxx2000-S-C3	BXEB-L1140F- xxx4000-S-C3
Maximum Drive Current	154mA	308mA	616mA	1232mA

Notes for Table 3:

1. For IEC 62717 requirement, please consult your Bridgelux sales representative.
2. Lumen maintenance (L70) and lifetime predictions are valid for drive current and case temperature conditions used for LM-80 testing as included in the applicable LM-80 test report for the SMDs used in the modules. Contact your Bridgelux sales representatives for LM-80 report.

# Performance Curves

Figure 1: Relative Forward Current vs. Forward Voltage,  $T_c=25^\circ\text{C}$

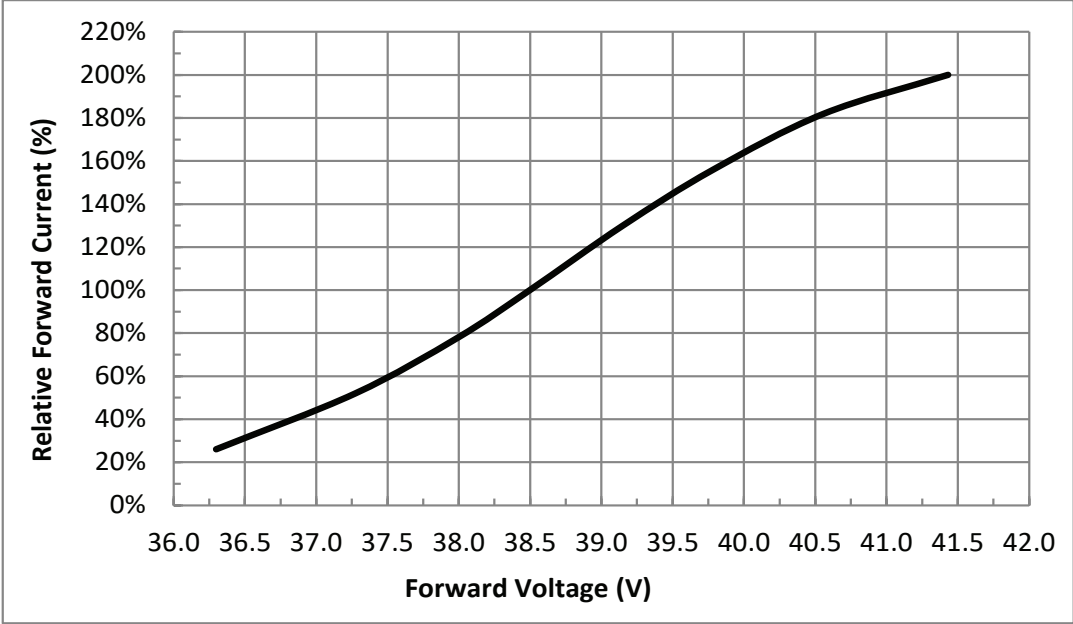
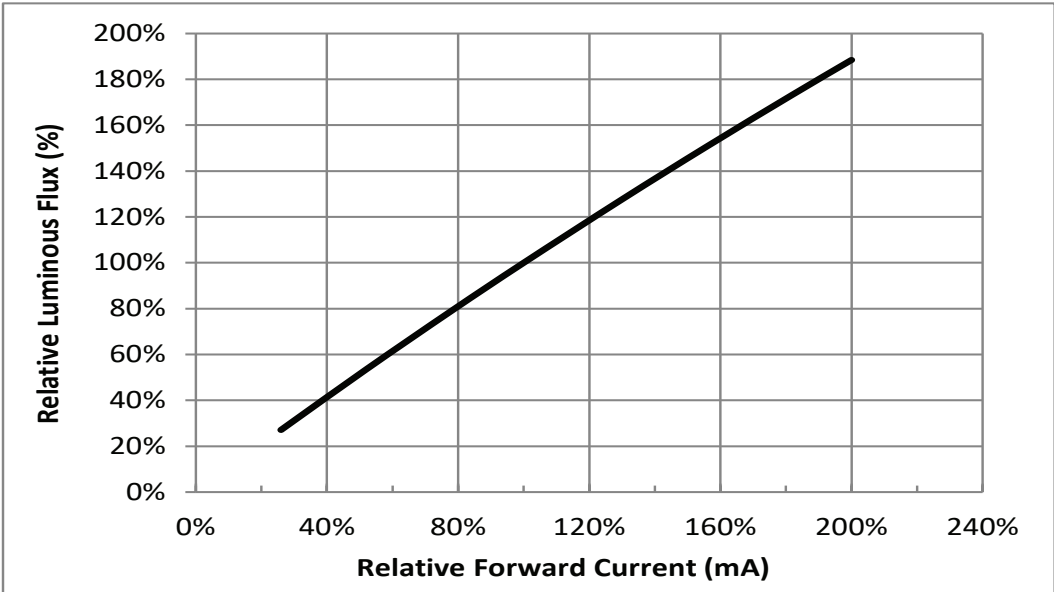

Figure 2: Relative Luminous Flux vs. Relative Forward Current,  $T_c=25^\circ\text{C}$



# Performance Curves

Figure 3: Relative Voltage vs. Case Temperature

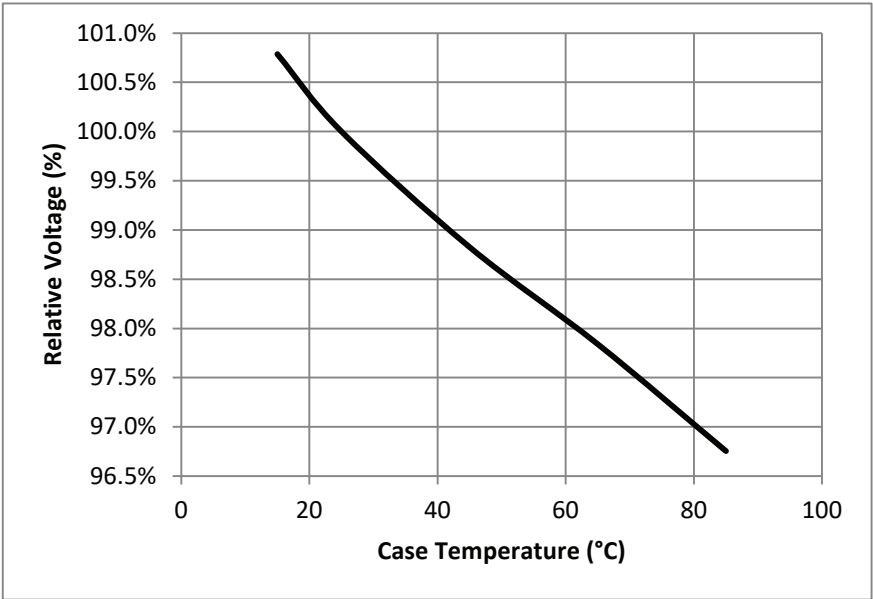
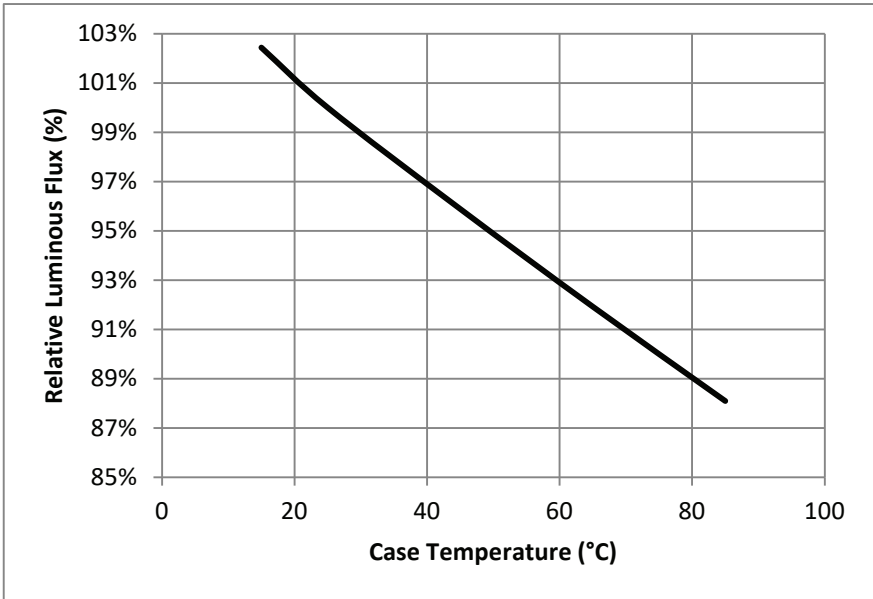
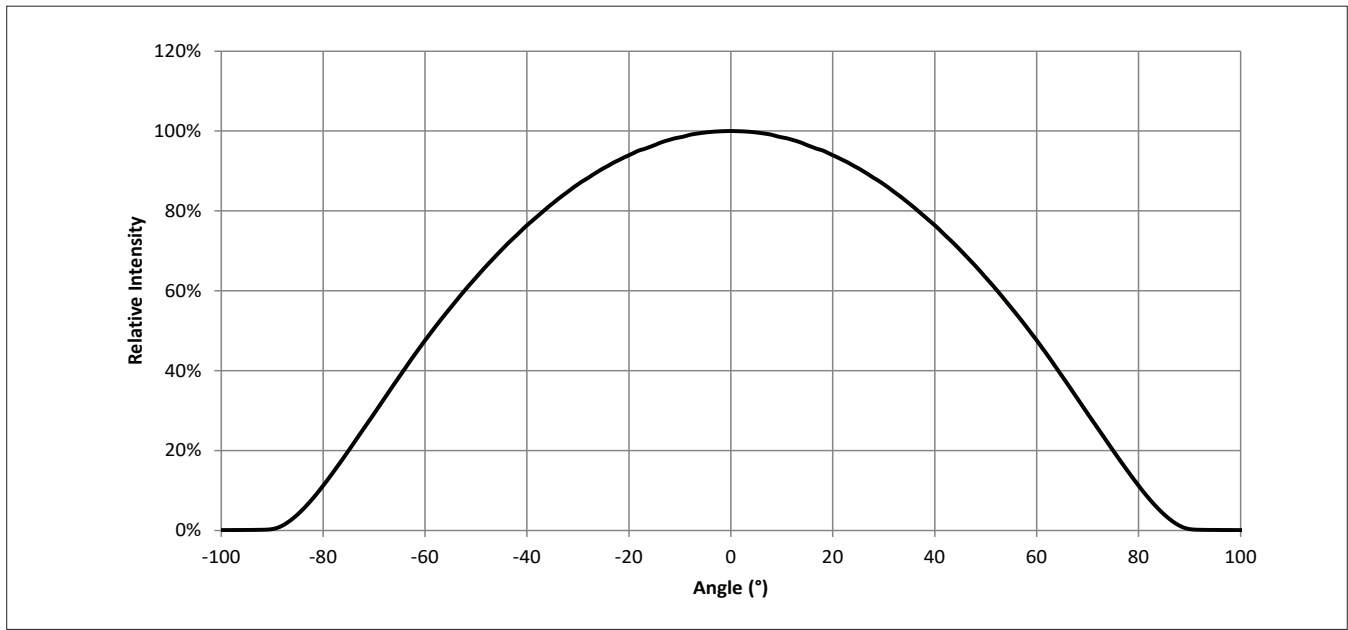

Figure 4: Relative Luminous Flux vs. Case Temperature



# Typical Radiation Pattern

**Figure 5: Typical Spatial Radiation Pattern**



Notes for Figure 5:

1. Typical viewing angle is 120°.
2. The viewing angle is defined as the off axis angle from the centerline where  $I_v$  is  $\frac{1}{2}$  of the peak value.



# Typical Color Spectrum

Figure 6: Typical Color Spectra, 90 CRI

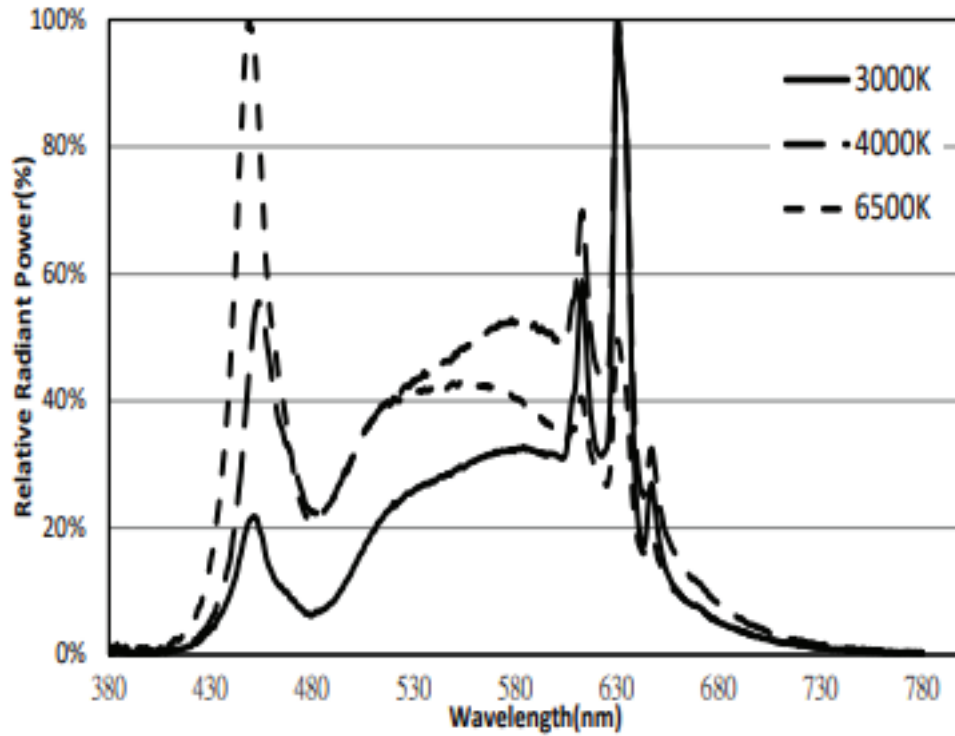

Note for Figures 6:

1. Color spectra measured at nominal current for  $T_c = 85^\circ\text{C}$

# Mechanical Dimensions

Figure 7: Drawing for EB Series Gen3 F90 140mm

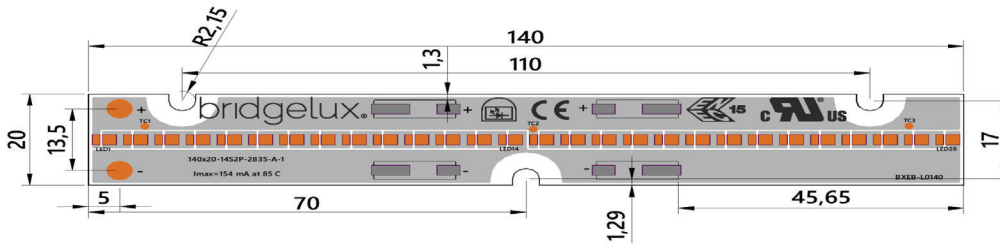

Table 4: Dimensions for 140mm

Parameter	Specification	Unit
Linear length	140	mm
Linear width	20	mm
Linear thickness	6.1	mm
PCB thickness	1.6	mm

Figure 8: Drawing for EB Series Gen3 F90 280mm

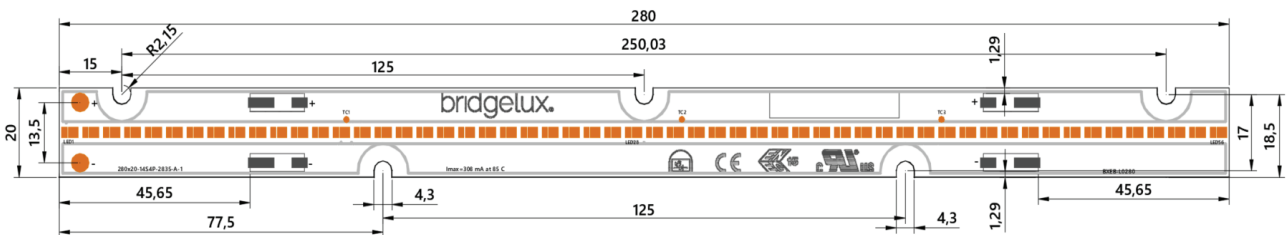

Table 5: Dimensions for 280mm

Parameter	Specification	Unit
Linear length	280	mm
Linear width	20	mm
Linear thickness	6.1	mm
PCB thickness	1.6	mm

# Mechanical Dimensions

Figure 9: Drawing for EB Series Gen3 F90 560mm

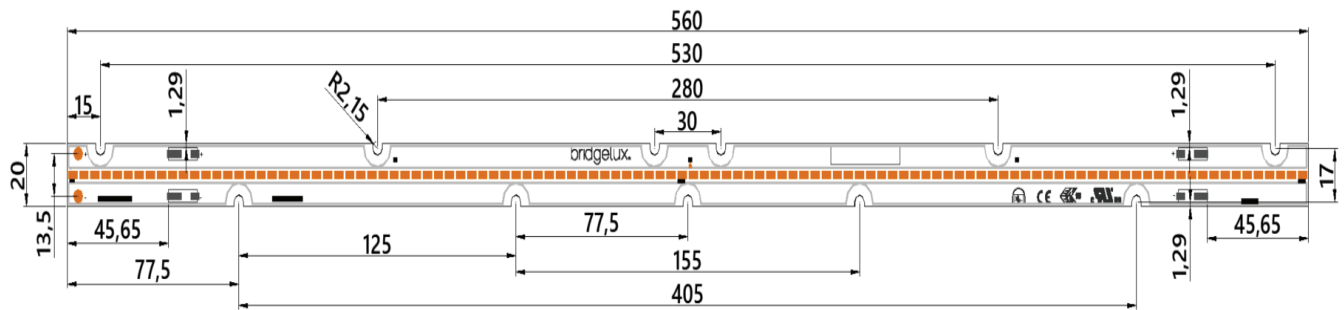
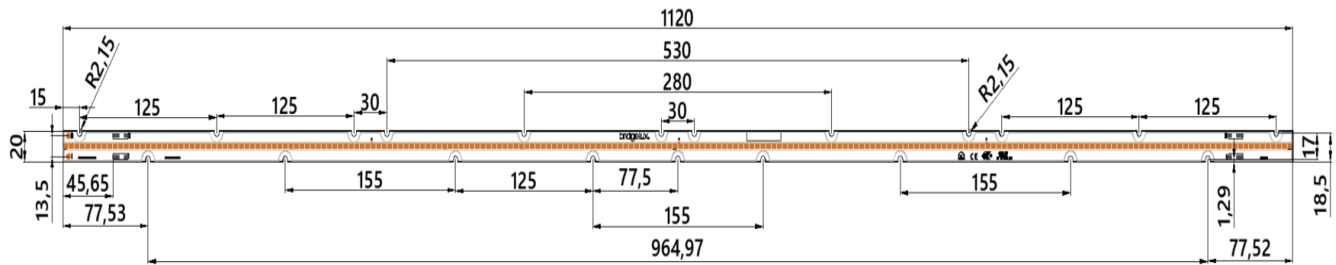

Table 6: Dimensions for 560mm

Parameter	Specification	Unit
Linear length	560	mm
Linear width	20	mm
Linear thickness	6.1	mm

# Mechanical Dimensions

Figure 10: Drawing for EB Series F90 Gen3 1120mm



Notes for Figures 7, 8, 9 & 10.

1. Solder pads are labeled "+" to denote positive polarity, and "-" to denote negative polarity.
2. Drawings are not to scale.
3. Drawing dimensions are in millimeters.

Table 7: Dimensions for 1120mm

Parameter	Specification	Unit
Linear length	1120	mm
Linear width	20	mm
Linear thickness	6.1	mm

Table 8: Connector and wiring

Parameter	Specification
Input wire cross-section	18-24 AWG
Wire strip length	7-9 mm

# Color Binning Information

**Figure 11: Graph of Warm and Neutral White Test Bins in xy Color Space**

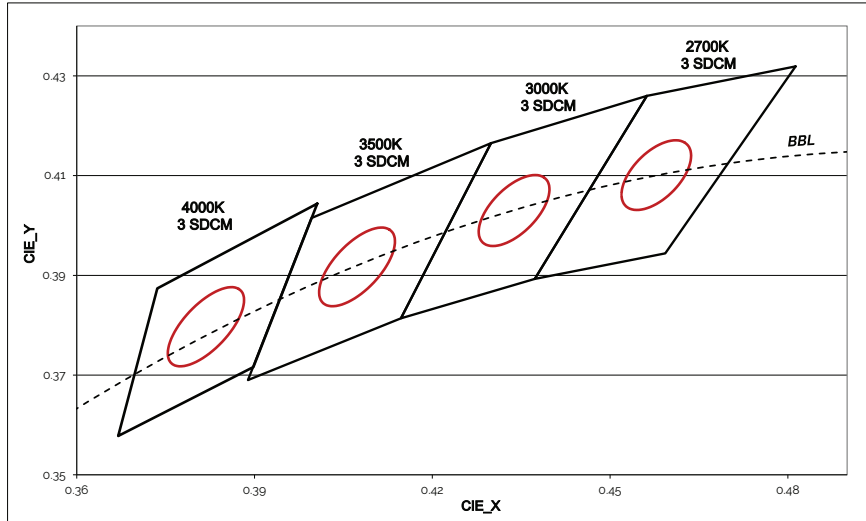

**Table 9: Warm and Neutral White xy Bin Coordinates and Associated Typical CCT**

Bin Code	2700K	3000K	3500 K	4000K
C3 (3 SDCM) CCT Range	2651K - 2794K	2968K - 3136K	3369K - 3586K	3851K - 4130K
Center Point (x, y)	(0.458, 0.410)	(0.434, 0.403)	(0.407, 0.392)	(0.382, 0.380)

**Figure 12: Graph of Cool White Test Bins in xy Color Space**

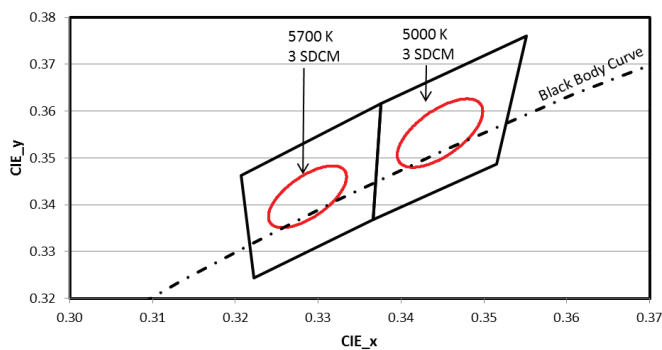

**Table 10: Cool White xy Bin Coordinates and Associated Typical**

Bin Code	5000K	5700K
C3 (3 SDCM) CCT Range	4835K - 5215K	5490K - 5820K
Center Point (x, y)	(0.3445, 0.355)	(0.329, 0.342)

Notes for Tables 9 and 10

1. Color binning at solder point temperature Tsp of SMDs at 85°C.
2. Bridgelux maintains a tolerance of ± 0.007 on x and y color coordinates in the CIE 1931 color space.

# Packaging and Labeling

**Figure 13: EB Series Packaging and Labeling**

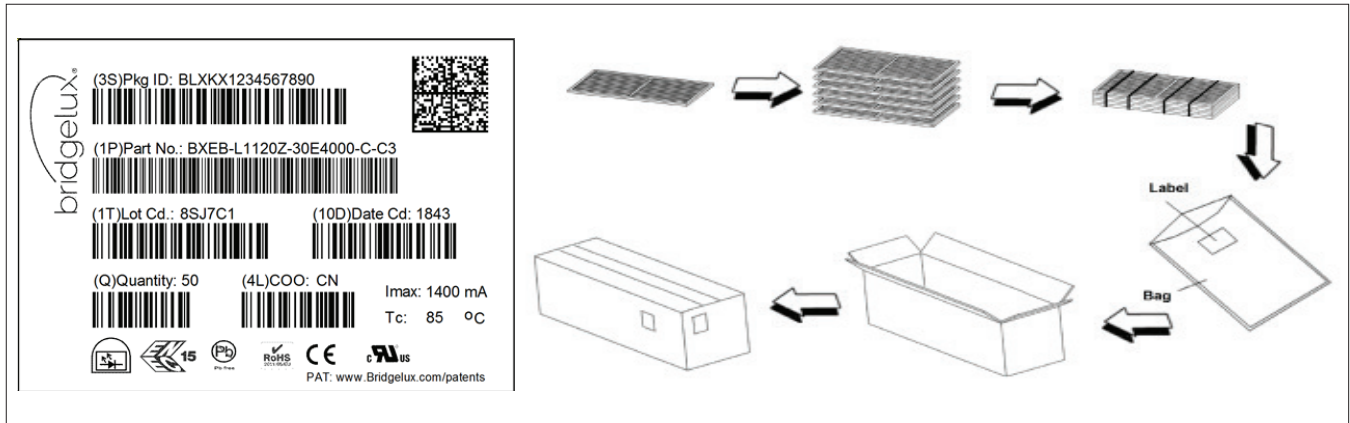

**Table 11: Packaging Structure**

L0140 modules	Tray	Box
Quantity	80	400
Dimension	63 cm x 39 cm x 2.4 cm	65.5 cm x 41.5 cm x 15.5 cm
L0280 modules	Tray	Box
Quantity	40	200
Dimension	63 cm x 39 cm x 2.4 cm	65.5 cm x 41.5 cm x 15.5 cm
L0560 modules	Tray	Box
Quantity	20	100
Dimension	63 cm x 39 cm x 2.4 cm	65.5 cm x 41.5 cm x 15.5 cm
L1120 modules	Tray	Box
Quantity	20	100
Dimension	119 cm x 39 cm x 2.4 cm	134 cm x 44 cm x 18.5 cm

**Figure 14: Product Labeling**

Bridgelux EB Series modules contain a label on the front to help with product identification. In addition to the product identification markings, Bridgelux EB Series modules also contain markings for internal Bridgelux manufacturing use only. The image below shows which markings are for customer use and which ones are for Bridgelux internal use only. The Bridgelux internal manufacturing markings are subject to change without notice, however these will not impact the form, function or performance of the module.



EB Series Gen3  
1ft 1000lm 350mA

Customer Use- 2D Barcode  
Scannable barcode provides  
product part number and other  
Bridgelux internal production  
information.

# Design Resources

## Application Notes

Bridgelux has developed a comprehensive set of application notes and design resources to assist customers in successfully designing with the EB Series product family. For a list of resources under development, visit [www.bridgelux.com](http://www.bridgelux.com).

## Optical Source Models

Optical source models and ray set files are available for all Bridgelux products. For a list of available formats, visit [www.bridgelux.com](http://www.bridgelux.com).

## 3D CAD Models

Three dimensional CAD models depicting the product outline of all Bridgelux EB Series LED linears are available in both IGES and STEP formats. Please contact your Bridgelux sales representative for assistance.

# Precautions

## CAUTION: CHEMICAL EXPOSURE HAZARD

Exposure to some chemicals commonly used in luminaire manufacturing and assembly can cause damage to the LED linear. Please consult Bridgelux Application Note for additional information.

## CAUTION: EYE SAFETY

Eye safety classification for the use of Bridgelux EB Series is in accordance with IEC/TR62778: Application of IEC 62471 for the assessment of blue light hazard to light sources and luminaires. EB Series linears are classified as Risk Group 1 when operated at or below the maximum drive current. Please use appropriate precautions. It is important that employees working with LEDs are trained to use them safely.

## CAUTION: RISK OF BURN

Do not touch the EB Series linears during operation. Allow the linear to cool for a sufficient period of time before handling. The EB Series linears may reach elevated temperatures such that could burn skin when touched.

## CAUTION

### CONTACT WITH LIGHT EMITTING SURFACE (LES)

Avoid any contact with the LES. Do not touch the LES of the linear or apply stress to the LES (yellow phosphor resin area). Contact may cause damage to the linear.

Optics and reflectors must not be mounted in contact with the LES (yellow phosphor resin area). Optical devices may be mounted on the top surface of the EB Series linear. Use the mechanical features of the linear housing, edges and/or mounting holes to locate and secure optical devices as needed.

# Disclaimers

## STANDARD TEST CONDITIONS

Unless otherwise stated, linear testing is performed at the nominal drive current.

## MINOR PRODUCT CHANGE POLICY

The rigorous qualification testing on products offered by Bridgelux provides performance assurance. Slight cosmetic changes that do not affect form, fit, or function may occur as Bridgelux continues product optimization.

# About Bridgelux: Bridging Light and Life™

At Bridgelux, we help companies, industries and people experience the power and possibility of light. Since 2002, we've designed LED solutions that are high performing, energy efficient, cost effective and easy to integrate. Our focus is on light's impact on human behavior, delivering products that create better environments, experiences and returns—both experiential and financial. And our patented technology drives new platforms for commercial and industrial luminaires.

**For more information about the company, please visit**

**[bridgelux.com](http://bridgelux.com)**

**[twitter.com/Bridgelux](https://twitter.com/Bridgelux)**

**[facebook.com/Bridgelux](https://facebook.com/Bridgelux)**

**[youtube.com/user/Bridgelux](https://youtube.com/user/Bridgelux)**

**[linkedin.com/company/bridgelux](https://linkedin.com/company/bridgelux)**

**WeChat ID: BridgeluxInChina**



46410 Fremont Blvd  
Fremont, CA 94538 USA  
Tel (925) 583-8400  
Fax (925) 583-8401  
**[www.bridgelux.com](http://www.bridgelux.com)**

© 2023 Bridgelux, Inc. All rights reserved. Product specifications are subject to change without notice. Bridgelux and the Bridgelux stylized logo design are registered trademarks of Bridgelux, Inc. EB Series and Bridging Light and Life are trademarks of Bridgelux, Inc. All other trademarks are the property of their respective owners.

**Bridgelux EB Series Gen3 F90 SE Data Sheet DS141 Rev. B (11/2023)**