



Bridgelux® Gen 7 Vero® 10 Array

Product Data Sheet DS90



Introduction

Vero® Series



Vero® Series is a revolutionary advancement in chip on board (COB) light source technology and innovation. Vero LED light sources simplify luminaire design and manufacturing processes. Vero Chip on Board (COB) LED arrays are available in four LES configurations, engineered to enable new degrees of flexibility and reliability over a broad range of electrical currents. Vero arrays deliver increased lumen density to enable improved beam control and precision lighting with 2 and 3 SDCM color control standard for clean and consistent uniform lighting.

Vero products include an onboard connector port that enables a solder-free electrical interconnect, and simple mounting features for plug-and-play installation.

Bridgelux Décor Series™ is our state-of-the-art color line designed specifically for premium applications, producing unmatched LED light quality with brilliant color-rendering options and pleasing lighting palettes. Bridgelux Décor Series color points are available on Vero® SE Series, Vero® Series, V Series™ and V Series™ HD.

Décor Series™ Class A is based on human response testing, providing color points with a combined GAI and CRI metric.

Décor Series™ Ultra products provide a high CRI of 97 and minimum R₉ value of 93, which emphasizes the reds and color tones to which the human eye is most receptive - perfect for the most luxurious retail shops and world renowned museums. Décor Series Ultra is designed as a replacement for halogen lamps.

Décor Series™ Street and Landmark is designed to be a direct replacement for high pressure sodium lamps.

Décor Series™ Showcase is the optimal solution for replacing ceramic metal halide lamps, incorporating the same pure white light with enhanced spectrum coverage and higher efficacy.

Features

- Efficacy of 167 lm/W typical
- Lumen output performance ranges from 520 to 4,100 lumens
- Broad range of CCT options from 2700K to 6500K
- CRI options include minimum 65, 70, 80, and 90
- 2 and 3 SDCM color control for 2700K-4000K CCT
- Reliable operation at up to 2X nominal drive current
- Radial die pattern and improved lumen density
- Thermally isolated solder pads
- On-board connector port
- Top side part number markings
- V_f bin code backside marking

Benefits

- Broad application coverage for interior and exterior lighting
- Flexibility for application driven lighting design requirements
- High quality true color reproduction
- Uniform consistent white light
- Flexibility in design optimization
- Enhanced ease of use and assembly
- Solderless connectivity enables plug & play installation and field upgradability
- Improved inventory management and quality control



Contents

Product Feature Map	2
Product Nomenclature	2
Product Selection Guide	3
European Product Registry for Energy Labeling	10
Performance at Commonly Used Drive Currents	13
Electrical Characteristics	22
Eye Safety	23
Absolute Maximum Ratings	24
Performance Curves	25
Typical Radiation Pattern	28
Typical Color Spectrum	29
Mechanical Dimensions	30
Color Binning Information	31
Packaging and Labeling	32
Design Resources	34
Precautions	34
Disclaimers	34
About Bridgelux	35

Product Feature Map

Vero 10 is the smallest form factor in the Vero family of next generation solid state light sources. In addition to delivering the performance and light quality required for many lighting applications, Vero incorporates several

features to simplify the design integration and manufacturing process, accelerate time to market and reduce system costs. Please visit www.bridgelux.com for more information on the Vero Series family of products.

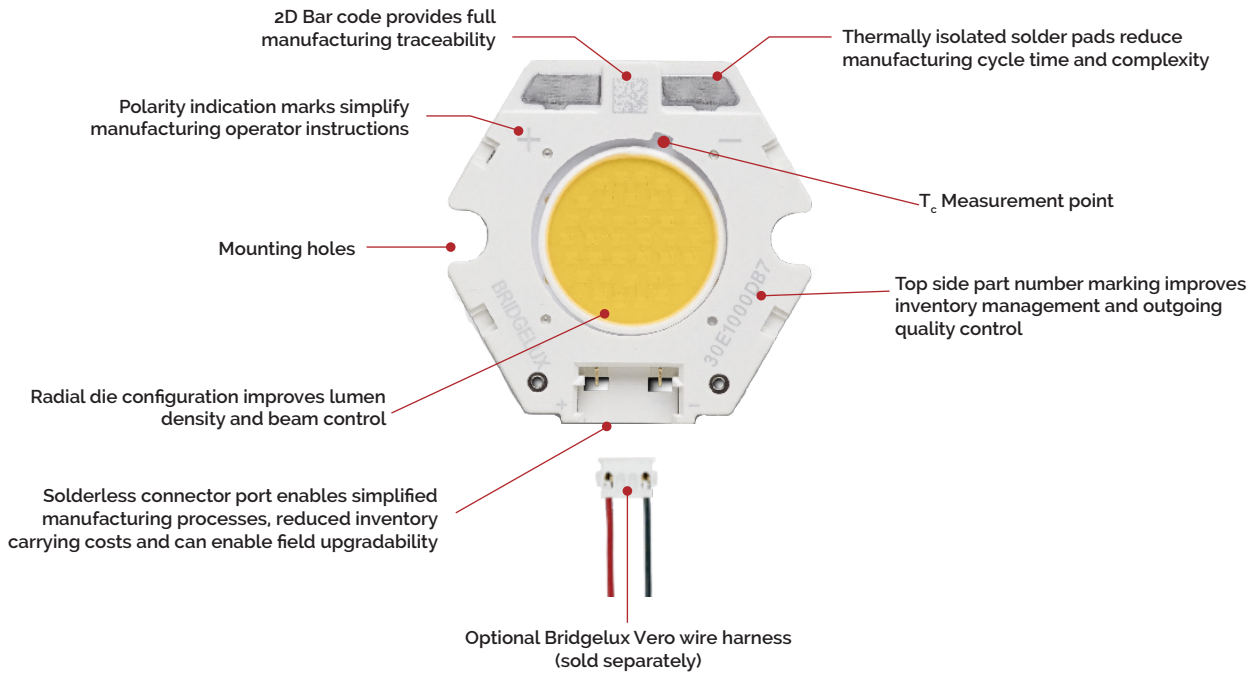

Product Nomenclature

The part number designation for Bridgelux Vero LED arrays is explained as follows:

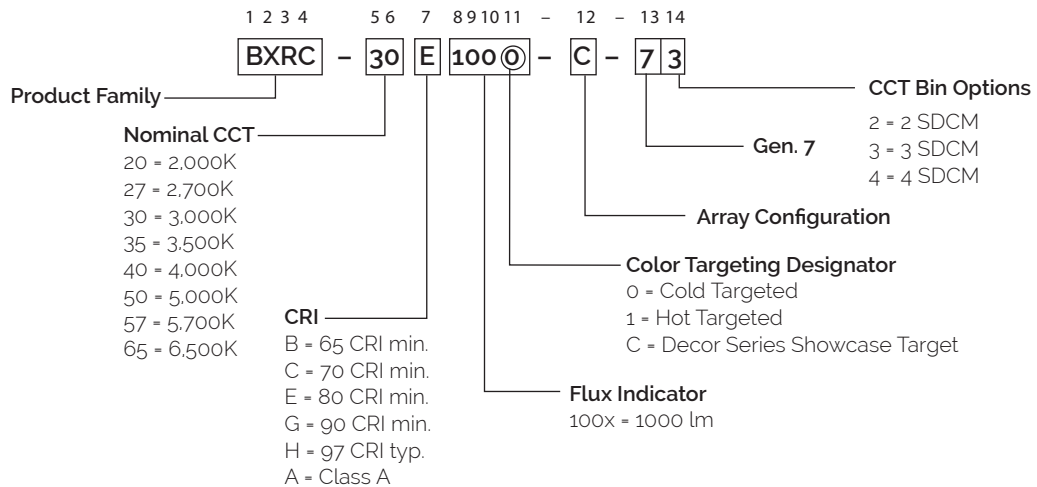

Product Selection Guide

The following product configurations are available:

Table 1: Selection Guide, Pulsed Measurement Data ($T_j = T_c = 25^\circ\text{C}$)

Part Number	Nominal CCT ¹ (K)	CRI ²	Nominal Drive Current ³ (mA)	Typical Pulsed Flux ^{4,5,6} $T_c = 25^\circ\text{C}$ (lm)	Minimum Pulsed Flux ^{6,7} $T_c = 25^\circ\text{C}$ (lm)	Typical V_f (V)	Typical Power (W)	Typical Efficacy (lm/W)
BXRC-20B1000-B-7x	2000	65	270	1431	1259	34.8	9.4	152
BXRC-20B1000-D-7x	2000	65	350	1386	1220	26.0	9.1	152
BXRC-27E1000-B-7x	2700	80	270	1458	1283	34.8	9.4	155
BXRC-27E1000-C-7x	2700	80	360	1944	1711	34.8	12.5	155
BXRC-27E1000-D-7x	2700	80	350	1412	1243	26.0	9.1	155
BXRC-27G10H0-B-7x	2700	90	270	1249	1099	34.8	9.4	133
BXRC-27G10H0-C-7x	2700	90	360	1665	1465	34.8	12.5	133
BXRC-27G10H0-D-7x	2700	90	350	1209	1064	26.0	9.1	133
BXRC-27G1000-B-7x	2700	90	270	1203	1059	34.8	9.4	128
BXRC-27G1000-C-7x	2700	90	360	1604	1412	34.8	12.5	128
BXRC-27G1000-D-7x	2700	90	350	1165	1025	26.0	9.1	128
BXRC-27H1000-B-7x	2700	97	270	1066	938	34.8	9.4	113
BXRC-27H1000-C-7x	2700	97	360	1422	1251	34.8	12.5	113
BXRC-27H1000-D-7x	2700	97	350	1033	909	26.0	9.1	113
BXRC-30C1001-B-7x	3000	70	270	1622	1428	34.8	9.4	173
BXRC-30C1001-C-7x	3000	70	360	2163	1904	34.8	12.5	173
BXRC-30C1001-D-7x	3000	70	350	1571	1383	26.0	9.1	173
BXRC-30E1000-B-7x	3000	80	270	1549	1363	34.8	9.4	165
BXRC-30E1000-C-7x	3000	80	360	2066	1818	34.8	12.5	165
BXRC-30E1000-D-7x	3000	80	350	1501	1321	26.0	9.1	165
BXRC-30G10H0-B-7x	3000	90	270	1312	1155	34.8	9.4	140
BXRC-30G10H0-C-7x	3000	90	360	1750	1540	34.8	12.5	140
BXRC-30G10H0-D-7x	3000	90	350	1271	1119	26.0	9.1	140
BXRC-30G1000-B-7x	3000	90	270	1258	1107	34.8	9.4	134
BXRC-30G1000-C-7x	3000	90	360	1677	1476	34.8	12.5	134
BXRC-30G1000-D-7x	3000	90	350	1218	1072	26.0	9.1	134
BXRC-30G100C-B-7x	3000	90	270	1212	1067	34.8	9.4	129
BXRC-30G100C-D-7x	3000	90	350	1174	1033	26.0	9.1	129
BXRC-30H1000-B-7x	3000	97	270	1139	1003	34.8	9.4	121
BXRC-30H1000-C-7x	3000	97	360	1519	1337	34.8	12.5	121
BXRC-30H1000-D-7x	3000	97	350	1103	971	26.0	9.1	121
BXRC-30A1001-B-7x ^{8,9}	3000	93	270	1130	995	34.8	9.4	120

Notes for Table 1:

- Nominal CCT as defined by ANSI C78.377-2011. Products with a CCT of 5000K-6500K are hot targeted to $T_c = 85^\circ\text{C}$.
- CRI values are typical for Decor Series Ultra, Decor Series Street and Landmark and Decor Series Class A products. CRI values are minimums for all other products. Minimum Rg value for 80 CRI products is 0, the minimum Rg value for 90 CRI products is 50, the minimum Rg value for 97 CRI products is 93 when 2700K and 3000K. Bridgelux maintains a ± 3 tolerance on CRI and Rg values.
- Drive current is referred to as nominal drive current.
- Products tested under pulsed condition (10ms pulse width) at nominal test current where T_j (junction temperature) - T_c (case temperature) = 25°C .
- Typical performance values are provided as a reference only and are not a guarantee of performance.
- Bridgelux maintains a $\pm 7\%$ tolerance on flux measurements.
- Minimum flux values at the nominal test current are guaranteed by 100% test.
- Nominal CCT is defined by the Lighting Research Center's Class A definition. The center of the Class A color bin is on the corresponding isothermal line.
- GAI value is 80. To help ensure optimal fixture level performance, GAI is measured at the fixture level, on axis, at a case temperature of 70°C . GAI may vary depending on fixture design and performance.

Product Selection Guide

Table 1: Selection Guide, Pulsed Measurement Data ($T_j = T_c = 25^\circ\text{C}$) (continued)

Part Number	Nominal CCT ¹ (K)	CRI ²	Nominal Drive Current ³ (mA)	Typical Pulsed Flux ^{4,5,6} $T_c = 25^\circ\text{C}$ (lm)	Minimum Pulsed Flux ^{6,7} $T_c = 25^\circ\text{C}$ (lm)	Typical V_f (V)	Typical Power (W)	Typical Efficacy (lm/W)
BXRC-30A1001-C-7x ^{8,9}	3000	93	360	1507	1326	34.8	12.5	120
BXRC-30A1001-D-7x ^{8,9}	3000	93	350	1095	963	26.0	9.1	120
BXRC-35E1000-B-7x	3500	80	270	1586	1396	34.8	9.4	169
BXRC-35E1000-C-7x	3500	80	360	2114	1861	34.8	12.5	169
BXRC-35E1000-D-7x	3500	80	350	1536	1352	26.0	9.1	169
BXRC-35G1000-B-7x	3500	90	270	1303	1147	34.8	9.4	139
BXRC-35G1000-C-7x	3500	90	360	1738	1529	34.8	12.5	139
BXRC-35G1000-D-7x	3500	90	350	1262	1111	26.0	9.1	139
BXRC-35A1001-B-7x ^{8,9}	3500	93	270	1203	1059	34.8	9.4	128
BXRC-35A1001-C-7x ^{8,9}	3500	93	360	1604	1412	34.8	12.5	128
BXRC-35A1001-D-7x ^{8,9}	3500	93	350	1165	1025	26.0	9.1	128
BXRC-40C1001-B-7x	4000	70	270	1668	1468	34.8	9.4	178
BXRC-40C1001-C-7x	4000	70	360	2224	1957	34.8	12.5	178
BXRC-40C1001-D-7x	4000	70	350	1615	1422	26.0	9.1	178
BXRC-40E1000-B-7x	4000	80	270	1595	1404	34.8	9.4	170
BXRC-40E1000-C-7x	4000	80	360	2127	1871	34.8	12.5	170
BXRC-40E1000-D-7x	4000	80	350	1545	1359	26.0	9.1	170
BXRC-40G1000-B-7x	4000	90	270	1331	1171	34.8	9.4	142
BXRC-40G1000-C-7x	4000	90	360	1774	1561	34.8	12.5	142
BXRC-40G1000-D-7x	4000	90	350	1289	1134	26.0	9.1	142
BXRC-40H1000-B-7x	4000	97	270	1203	1059	34.8	9.4	128
BXRC-40H1000-C-7x	4000	97	360	1604	1412	34.8	12.5	128
BXRC-40H1000-D-7x	4000	97	350	1165	1025	26.0	9.1	128
BXRC-40A1001-B-7x ^{8,9}	4000	93	270	1303	1147	34.8	9.4	139
BXRC-40A1001-C-7x ^{8,9}	4000	93	360	1738	1529	34.8	12.5	139
BXRC-40A1001-D-7x ^{8,9}	4000	93	350	1262	1111	26.0	9.1	139
BXRC-50C1001-B-7x	5000	70	270	1677	1476	34.8	9.4	178
BXRC-50C1001-C-7x	5000	70	360	2236	1968	34.8	12.5	178
BXRC-50C1001-D-7x	5000	70	350	1624	1429	26.0	9.1	178
BXRC-50E1001-B-7x	5000	80	270	1613	1420	34.8	9.4	172
BXRC-50E1001-C-7x	5000	80	360	2151	1893	34.8	12.5	172
BXRC-50E1001-D-7x	5000	80	350	1562	1375	26.0	9.1	172
BXRC-50G1001-B-7x	5000	90	270	1394	1227	34.8	9.4	148
BXRC-50G1001-C-7x	5000	90	360	1859	1636	34.8	12.5	148
BXRC-50G1001-D-7x	5000	90	350	1351	1188	26.0	9.1	148

Notes for Table 1:

- Nominal CCT as defined by ANSI C78.377-2011. Products with a CCT of 5000K-6500K are hot targeted to $T_c = 85^\circ\text{C}$.
- CRI values are typical for Decor Series Ultra, Decor Series Street and Landmark and Decor Series Class A products. CRI values are minimums for all other products. Minimum Rg value for 80 CRI products is 0, the minimum Rg value for 90 CRI products is 50, the minimum Rg value for 97 CRI products is 93 when 2700K and 3000K. Bridgelux maintains a ± 3 tolerance on CRI and Rg values.
- Drive current is referred to as nominal drive current.
- Products tested under pulsed condition (10ms pulse width) at nominal test current where T_j (junction temperature) = T_c (case temperature) = 25°C .
- Typical performance values are provided as a reference only and are not a guarantee of performance.
- Bridgelux maintains a $\pm 7\%$ tolerance on flux measurements.
- Minimum flux values at the nominal test current are guaranteed by 100% test.
- Nominal CCT is defined by the Lighting Research Center's Class A definition. The center of the Class A color bin is on the corresponding isothermal line.
- GAI value is 80. To help ensure optimal fixture level performance, GAI is measured at the fixture level, on axis, at a case temperature of 70°C . GAI may vary depending on fixture design and performance.

Product Selection Guide

Table 1: Selection Guide, Pulsed Measurement Data ($T_j = T_c = 25^\circ\text{C}$) (continued)

Part Number	Nominal CCT ¹ (K)	CRI ²	Nominal Drive Current ³ (mA)	Typical Pulsed Flux ^{4,5,6} $T_c = 25^\circ\text{C}$ (lm)	Minimum Pulsed Flux ^{6,7} $T_c = 25^\circ\text{C}$ (lm)	Typical V_f (V)	Typical Power (W)	Typical Efficacy (lm/W)
BXRC-57C1001-B-7x	5700	70	270	1631	1436	34.8	9.4	174
BXRC-57C1001-C-7x	5700	70	360	2175	1914	34.8	12.5	174
BXRC-57C1001-D-7x	5700	70	350	1580	1390	26.0	9.1	174
BXRC-57E1001-B-7x	5700	80	270	1549	1363	34.8	9.4	165
BXRC-57E1001-C-7x	5700	80	360	2066	1818	34.8	12.5	165
BXRC-57E1001-D-7x	5700	80	350	1501	1321	26.0	9.1	165
BXRC-65C1001-B-7x	6500	70	270	1631	1436	34.8	9.4	174
BXRC-65C1001-C-7x	6500	70	360	2175	1914	34.8	12.5	174
BXRC-65C1001-D-7x	6500	70	350	1580	1390	26.0	9.1	174
BXRC-65E1001-B-7x	6500	80	270	1568	1380	34.8	9.4	167
BXRC-65E1001-C-7x	6500	80	360	2090	1839	34.8	12.5	167
BXRC-65E1001-D-7x	6500	80	350	1518	1336	26.0	9.1	167

Notes for Table 1:

- Nominal CCT as defined by ANSI C78.377-2011. Products with a CCT of 5000K-6500K are hot targeted to $T_c = 85^\circ\text{C}$.
- CRI values are typical for Decor Series Ultra, Decor Series Street and Landmark and Decor Series Class A products. CRI values are minimums for all other products. Minimum Rg value for 80 CRI products is 0, the minimum Rg value for 90 CRI products is 50, the minimum Rg value for 97 CRI products is 93 when 2700K and 3000K. Bridgelux maintains a ± 3 tolerance on CRI and Rg values.
- Drive current is referred to as nominal drive current.
- Products tested under pulsed condition (10ms pulse width) at nominal test current where T_j (junction temperature) - T_c (case temperature) = 25°C .
- Typical performance values are provided as a reference only and are not a guarantee of performance.
- Bridgelux maintains a $\pm 7\%$ tolerance on flux measurements.
- Minimum flux values at the nominal test current are guaranteed by 100% test.
- Nominal CCT is defined by the Lighting Research Center's Class A definition. The center of the Class A color bin is on the corresponding isothermal line.
- GAI value is 80. To help ensure optimal fixture level performance, GAI is measured at the fixture level, on axis, at a case temperature of 70°C . GAI may vary depending on fixture design and performance.

Product Selection Guide

Table 2: Selection Guide. Stabilized DC Performance ($T_c = 70^\circ\text{C}$) ^{7,8}

Part Number	Nominal CCT ¹ (K)	GAI ²	CRI ³	Nominal Drive Current ⁴ (mA)	Typical DC Flux ^{5,6} $T_c = 70^\circ\text{C}$ (lm)	Minimum DC Flux ^{6,9} $T_c = 70^\circ\text{C}$ (lm)	Typical V_f (V)	Typical Power (W)	Typical Efficacy (lm/W)
BXRC-30A1001-B-7x	3000	80	93	270	1051	875	34.3	9.3	114
BXRC-30A1001-C-7x	3000	80	93	360	1401	1167	34.3	12.3	114
BXRC-30A1001-D-7x	3000	80	93	350	1018	848	25.5	8.9	114
BXRC-35A1001-B-7x	3500	80	93	270	1119	1228	34.3	9.3	121
BXRC-35A1001-C-7x	3500	80	93	360	1492	1637	34.3	12.3	121
BXRC-35A1001-D-7x	3500	80	93	350	1084	1189	25.5	8.9	122
BXRC-40A1001-B-7x	4000	80	93	270	1212	1009	34.3	9.3	131
BXRC-40A1001-C-7x	4000	80	93	360	1616	1346	34.3	12.3	131
BXRC-40A1001-D-7x	4000	80	93	350	1174	977	25.5	8.9	132

Notes for Table 2:

1. Nominal CCT is defined by the Lighting Research Center's Class A definition. The center of the Class A color bin is on the corresponding isothermal line.
2. To help ensure optimal fixture level performance, GAI is measured at the fixture level, on axis, at a case temperature of 70°C . GAI may vary depending on fixture design and performance.
3. CRI Values are specified as typical.
4. Drive current is referred to as nominal drive current.
5. Typical performance values are provided as a reference only and are not a guarantee of performance.
6. Bridgelux maintains a $\pm 7\%$ tolerance on flux measurements.
7. Typical stabilized DC performance values are provided as reference only and are not a guarantee of performance.
8. Typical performance is estimated based on operation under DC (direct current) with LED array mounted onto a heat sink with thermal interface material and the case temperature maintained at specified temperature. Based on Bridgelux test setup, values may vary depending on the thermal design of the luminaire and/or the exposed environment to which the product is subjected.
9. Minimum flux values at elevated temperatures are provided for reference only and are not guaranteed by 100% production testing. Based on Bridgelux test setup, values may vary depending on the thermal design of the luminaire and/or the exposed environment to which the product is subjected.

Product Selection Guide

Table 3: Selection Guide, Stabilized DC Performance ($T_c = 85^\circ\text{C}$)^{4,5}

Part Number	Nominal CCT ¹ (K)	CRI ²	Nominal Drive Current ³ (mA)	Typical DC Flux ^{4,5} $T_c = 85^\circ\text{C}$ (lm)	Minimum DC Flux ⁶ $T_c = 85^\circ\text{C}$ (lm)	Typical V_f (V)	Typical Power (W)	Typical Efficacy (lm/W)
BXRC-20B1000-B-7x	2000	65	270	1288	1133	33.8	9.1	141
BXRC-20B1000-D-7x	2000	65	350	1247	1098	25.3	8.9	141
BXRC-27E1000-B-7x	2700	80	270	1312	1155	33.8	9.1	144
BXRC-27E1000-C-7x	2700	80	360	1750	1540	33.8	12.2	144
BXRC-27E1000-D-7x	2700	80	350	1271	1119	25.3	8.9	144
BXRC-27G10H0-B-7x	2700	90	270	1124	989	33.8	9.1	123
BXRC-27G10H0-C-7x	2700	90	360	1498	1319	33.8	12.2	123
BXRC-27G10H0-D-7x	2700	90	350	1088	958	25.3	8.9	123
BXRC-27G1000-B-7x	2700	90	270	1083	953	33.8	9.1	119
BXRC-27G1000-C-7x	2700	90	360	1444	1270	33.8	12.2	119
BXRC-27G1000-D-7x	2700	90	350	1049	923	25.3	8.9	118
BXRC-27H1000-B-7x	2700	97	270	960	845	33.8	9.1	105
BXRC-27H1000-C-7x	2700	97	360	1280	1126	33.8	12.2	105
BXRC-27H1000-D-7x	2700	97	350	929	818	25.3	8.9	105
BXRC-30C1001-B-7x	3000	70	270	1460	1285	33.8	9.1	160
BXRC-30C1001-C-7x	3000	70	360	1947	1713	33.8	12.2	160
BXRC-30C1001-D-7x	3000	70	350	1414	1244	25.3	8.9	160
BXRC-30E1000-B-7x	3000	80	270	1394	1227	33.8	9.1	153
BXRC-30E1000-C-7x	3000	80	360	1859	1636	33.8	12.2	153
BXRC-30E1000-D-7x	3000	80	350	1351	1188	25.3	8.9	153
BXRC-30G10H0-B-7x	3000	90	270	1181	1039	33.8	9.1	129
BXRC-30G10H0-C-7x	3000	90	360	1575	1386	33.8	12.2	129
BXRC-30G10H0-D-7x	3000	90	350	1144	1007	25.3	8.9	129
BXRC-30G1000-B-7x	3000	90	270	1132	996	33.8	9.1	124
BXRC-30G1000-C-7x	3000	90	360	1509	1328	33.8	12.2	124
BXRC-30G1000-D-7x	3000	90	350	1096	965	25.3	8.9	124
BXRC-30G100C-B-7x	3000	90	270	1091	960	33.8	9.1	120
BXRC-30G100C-D-7x	3000	90	350	1057	930	25.3	8.9	119
BXRC-30H1000-B-7x	3000	97	270	1025	902	33.8	9.1	112
BXRC-30H1000-C-7x	3000	97	360	1367	1203	33.8	12.2	112
BXRC-30H1000-D-7x	3000	97	350	993	874	25.3	8.9	112
BXRC-30A1001-B-7x ^{7,8}	3000	93	270	1017	895	33.8	9.1	111
BXRC-30A1001-C-7x ^{7,8}	3000	93	360	1356	1193	33.8	12.2	111
BXRC-30A1001-D-7x ^{7,8}	3000	93	350	985	867	25.3	8.9	111
BXRC-35E1000-B-7x	3500	80	270	1427	1256	33.8	9.1	156

Notes for Table 3:

- Nominal CCT as defined by ANSI C78.377-2011. Products with a CCT of 5000K-6500K are hot targeted to $T_c = 85^\circ\text{C}$.
- All CRI values are measured at $T_s = T_c = 25^\circ\text{C}$. CRI values are typical for Decor Series Ultra, Decor Series Street and Landmark and Decor Series Class A products. CRI values are minimums for all other products. Minimum Rg value for 80 CRI products is 0, the minimum Rg value for 90 CRI products is 50, the minimum Rg value for 97 CRI products is 93 when 2700K and 3000K. Bridgelux maintains a ± 3 tolerance on CRI and Rg values.
- Drive current is referred to as nominal drive current.
- Typical stabilized DC performance values are provided as reference only and are not a guarantee of performance.
- Typical performance is estimated based on operation under DC (direct current) with LED array mounted onto a heat sink with thermal interface material and the case temperature maintained at 85°C . Based on Bridgelux test setup, values may vary depending on the thermal design of the luminaire and/or the exposed environment to which the product is subjected.
- Minimum flux values at elevated temperatures are provided for reference only and are not guaranteed by 100% production testing. Based on Bridgelux test setup, values may vary depending on the thermal design of the luminaire and/or the exposed environment to which the product is subjected.
- Nominal CCT is defined by the Lighting Research Center's Class A definition. The center of the Class A color bin is on the corresponding isothermal line.
- GAI value is 80. To help ensure optimal fixture level performance, GAI is measured at the fixture level, on axis, at a case temperature of 70°C . GAI may vary depending on fixture design and performance.

Product Selection Guide

Table 3: Selection Guide, Stabilized DC Performance ($T_c = 85^\circ\text{C}$)^{4,5} (continued)

Part Number	Nominal CCT ¹ (K)	CRI ²	Nominal Drive Current ³ (mA)	Typical DC Flux ^{4,5} $T_c = 85^\circ\text{C}$ (lm)	Minimum DC Flux ⁶ $T_c = 85^\circ\text{C}$ (lm)	Typical V_f (V)	Typical Power (W)	Typical Efficacy (lm/W)
BXRC-35E1000-C-7x	3500	80	360	1903	1675	33.8	12.2	156
BXRC-35E1000-D-7x	3500	80	350	1382	1216	25.3	8.9	156
BXRC-35G1000-B-7x	3500	90	270	1173	1032	33.8	9.1	128
BXRC-35G1000-C-7x	3500	90	360	1564	1376	33.8	12.2	128
BXRC-35G1000-D-7x	3500	90	350	1136	1000	25.3	8.9	128
BXRC-35A1001-B-7x ^{7,8}	3500	93	270	1083	953	33.8	9.1	119
BXRC-35A1001-C-7x ^{7,8}	3500	93	360	1444	1270	33.8	12.2	119
BXRC-35A1001-D-7x ^{7,8}	3500	93	350	1049	923	25.3	8.9	118
BXRC-40C1001-B-7x	4000	70	270	1501	1321	33.8	9.1	164
BXRC-40C1001-C-7x	4000	70	360	2001	1761	33.8	12.2	164
BXRC-40C1001-D-7x	4000	70	350	1454	1279	25.3	8.9	164
BXRC-40E1000-B-7x	4000	80	270	1435	1263	33.8	9.1	157
BXRC-40E1000-C-7x	4000	80	360	1914	1684	33.8	12.2	157
BXRC-40E1000-D-7x	4000	80	350	1390	1223	25.3	8.9	157
BXRC-40G1000-B-7x	4000	90	270	1198	1054	33.8	9.1	131
BXRC-40G1000-C-7x	4000	90	360	1597	1405	33.8	12.2	131
BXRC-40G1000-D-7x	4000	90	350	1160	1021	25.3	8.9	131
BXRC-40H1000-B-7x	4000	97	270	1083	953	33.8	9.1	119
BXRC-40H1000-C-7x	4000	97	360	1444	1270	33.8	12.2	119
BXRC-40H1000-D-7x	4000	97	350	1049	923	25.3	8.9	118
BXRC-40A1001-B-7x ^{7,8}	4000	93	270	1173	1032	33.8	9.1	128
BXRC-40A1001-C-7x ^{7,8}	4000	93	360	1564	1376	33.8	12.2	128
BXRC-40A1001-D-7x ^{7,8}	4000	93	350	1136	1000	25.3	8.9	128
BXRC-50C1001-B-7x	5000	70	270	1509	1328	33.8	9.1	165
BXRC-50C1001-C-7x	5000	70	360	2012	1771	33.8	12.2	165
BXRC-50C1001-D-7x	5000	70	350	1462	1286	25.3	8.9	165
BXRC-50E1001-B-7x	5000	80	270	1452	1278	33.8	9.1	159
BXRC-50E1001-C-7x	5000	80	360	1936	1704	33.8	12.2	159
BXRC-50E1001-D-7x	5000	80	350	1406	1237	25.3	8.9	159
BXRC-50G1001-B-7x	5000	90	270	1255	1104	33.8	9.1	137
BXRC-50G1001-C-7x	5000	90	360	1673	1473	33.8	12.2	137
BXRC-50G1001-D-7x	5000	90	350	1215	1070	25.3	8.9	137

Notes for Table 3:

- Nominal CCT as defined by ANSI C78.377-2011. Products with a CCT of 5000K-6500K are hot targeted to $T_c = 85^\circ\text{C}$.
- All CRI values are measured at $T_c = 25^\circ\text{C}$. CRI values are typical for Decor Series Ultra, Decor Series Street and Landmark and Decor Series Class A products. CRI values are minimums for all other products. Minimum Rg value for 80 CRI products is 0, the minimum Rg value for 90 CRI products is 50, the minimum Rg value for 97 CRI products is 93 when 2700K and 3000K. Bridgelux maintains a ± 3 tolerance on CRI and Rg values.
- Drive current is referred to as nominal drive current.
- Typical stabilized DC performance values are provided as reference only and are not a guarantee of performance.
- Typical performance is estimated based on operation under DC (direct current) with LED array mounted onto a heat sink with thermal interface material and the case temperature maintained at 85°C . Based on Bridgelux test setup, values may vary depending on the thermal design of the luminaire and/or the exposed environment to which the product is subjected.
- Minimum flux values at elevated temperatures are provided for reference only and are not guaranteed by 100% production testing. Based on Bridgelux test setup, values may vary depending on the thermal design of the luminaire and/or the exposed environment to which the product is subjected.
- Nominal CCT is defined by the Lighting Research Center's Class A definition. The center of the Class A color bin is on the corresponding isothermal line.
- GAI value is 80. To help ensure optimal fixture level performance, GAI is measured at the fixture level, on axis, at a case temperature of 70°C . GAI may vary depending on fixture design and performance.

Product Selection Guide

Table 3: Selection Guide, Stabilized DC Performance ($T_c = 85^\circ\text{C}$)^{4,5}(continued)

Part Number	Nominal CCT ¹ (K)	CRI ²	Nominal Drive Current ³ (mA)	Typical DC Flux ^{4,5} $T_c = 85^\circ\text{C}$ (lm)	Minimum DC Flux ⁶ $T_c = 85^\circ\text{C}$ (lm)	Typical V_f (V)	Typical Power (W)	Typical Efficacy (lm/W)
BXRC-57C1001-B-7x	5700	70	270	1468	1292	33.8	9.1	161
BXRC-57C1001-C-7x	5700	70	360	1958	1723	33.8	12.2	161
BXRC-57C1001-D-7x	5700	70	350	1422	1251	25.3	8.9	161
BXRC-57E1001-B-7x	5700	80	270	1394	1227	33.8	9.1	153
BXRC-57E1001-C-7x	5700	80	360	1859	1636	33.8	12.2	153
BXRC-57E1001-D-7x	5700	80	350	1351	1188	25.3	8.9	153
BXRC-65C1001-B-7x	6500	70	270	1468	1292	33.8	9.1	161
BXRC-65C1001-C-7x	6500	70	360	1958	1723	33.8	12.2	161
BXRC-65C1001-D-7x	6500	70	350	1422	1251	25.3	8.9	161
BXRC-65E1001-B-7x	6500	80	270	1411	1242	33.8	9.1	154
BXRC-65E1001-C-7x	6500	80	360	1881	1655	33.8	12.2	154
BXRC-65E1001-D-7x	6500	80	350	1366	1202	25.3	8.9	154

Notes for Table 3:

- Nominal CCT as defined by ANSI C78.377-2011. Products with a CCT of 5000K-6500K are hot targeted to $T_c = 85^\circ\text{C}$.
- All CRI values are measured at $T_1 = T_c = 25^\circ\text{C}$. CRI values are typical for Decor Series Ultra, Decor Series Street and Landmark and Decor Series Class A products. CRI values are minimums for all other products. Minimum Rg value for 80 CRI products is 0, the minimum Rg value for 90 CRI products is 50, the minimum Rg value for 97 CRI products is 93 when 2700K and 3000K. Bridgelux maintains a ± 3 tolerance on CRI and Rg values.
- Drive current is referred to as nominal drive current.
- Typical stabilized DC performance values are provided as reference only and are not a guarantee of performance.
- Typical performance is estimated based on operation under DC (direct current) with LED array mounted onto a heat sink with thermal interface material and the case temperature maintained at 85°C . Based on Bridgelux test setup, values may vary depending on the thermal design of the luminaire and/or the exposed environment to which the product is subjected.
- Minimum flux values at elevated temperatures are provided for reference only and are not guaranteed by 100% production testing. Based on Bridgelux test setup, values may vary depending on the thermal design of the luminaire and/or the exposed environment to which the product is subjected.
- Nominal CCT is defined by the Lighting Research Center's Class A definition. The center of the Class A color bin is on the corresponding isothermal line.
- GAI value is 80. To help ensure optimal fixture level performance, GAI is measured at the fixture level, on axis, at a case temperature of 70°C . GAI may vary depending on fixture design and performance.

European Product Registry for Energy Labeling

The European Product Registry for Energy Labeling (EPREL) is defined in the EU Regulation 2017/1369 to provide important energy efficiency information to consumers. Together with Energy Labeling Regulation ELR (EU) 2019/2015 which was amended by regulation (EU) 2021/340 for energy labelling of light sources, manufacturers are required to declare an energy class based on key technical specifications from each of their product and register it in an open data base managed by EPREL. It is now a legal requirement for a vendor of light sources to upload information about their products into the EPREL database before placing these products on the market in the EU.

Table 4 below provides a list of part numbers that are in compliance with ELR and are currently listed in the EPREL database.

At Bridgelux, we are fully committed to supplying products that are compliant with pertinent laws, rules, and obligation imposed by relevant government bodies including the European Energy Labeling regulation. Customers can use these products with full confidence for any projects that fall under the ELR.

Table 4: Part numbers registered in European Product Registry for Energy Labeling

PART NUMBER ¹	CCT (K)	CRI	Current ² (mA)	Vf (V)	Useful flux ³ (Φ_{use}) at 85C (lm)	Power (W)	Efficacy (lm/W)	Energy efficiency class ⁴	Registration No	URL to Product Information Sheet in EPREL Database
BXRC-27E1000-B-7x	2700	80	540	35.1	2392	19.0	126	E	871000	https://eprelec.europa.eu/qr/871000
BXRC-27E1000-C-7x	2700	80	720	35.1	3186	25.3	126	E	871005	https://eprelec.europa.eu/qr/871005
BXRC-27E1000-D-7x	2700	80	700	27.7	2342	19.4	121	E	871010	https://eprelec.europa.eu/qr/871010
BXRC-27G10H0-B-7x	2700	90	540	35.1	2048	19.0	108	F	871083	https://eprelec.europa.eu/qr/871083
BXRC-27G10H0-C-7x	2700	90	720	35.1	2728	25.3	108	F	871087	https://eprelec.europa.eu/qr/871087
BXRC-27G10H0-D-7x	2700	90	680	27.6	1957	18.8	104	F	871091	https://eprelec.europa.eu/qr/871091
BXRC-27G1000-B-7x	2700	90	540	35.1	1973	19.0	104	F	871069	https://eprelec.europa.eu/qr/871069
BXRC-27G1000-C-7x	2700	90	670	34.8	2477	23.3	106	F	871074	https://eprelec.europa.eu/qr/871074
BXRC-27G1000-D-7x	2700	90	620	27.2	1749	16.9	104	F	871079	https://eprelec.europa.eu/qr/871079
BXRC-27H1000-B-7x	2700	95	430	34.1	1446	14.6	99	F	871185	https://eprelec.europa.eu/qr/871185
BXRC-27H1000-C-7x	2700	95	520	33.7	1769	17.5	101	F	871189	https://eprelec.europa.eu/qr/871189
BXRC-27H1000-D-7x	2700	95	500	26.5	1288	13.3	97	F	871193	https://eprelec.europa.eu/qr/871193
BXRC-30C1001-B-7x	3000	70	540	35.1	2661	19.0	140	E	871256	https://eprelec.europa.eu/qr/871256
BXRC-30C1001-C-7x	3000	70	720	35.1	3544	25.3	140	E	871262	https://eprelec.europa.eu/qr/871262
BXRC-30C1001-D-7x	3000	70	700	27.7	2606	19.4	134	E	871268	https://eprelec.europa.eu/qr/871268
BXRC-30E1000-B-7x	3000	80	540	35.1	2542	19.0	134	E	871330	https://eprelec.europa.eu/qr/871330
BXRC-30E1000-C-7x	3000	80	720	35.1	3385	25.3	134	E	871335	https://eprelec.europa.eu/qr/871335
BXRC-30E1000-D-7x	3000	80	700	27.7	2489	19.4	128	E	871340	https://eprelec.europa.eu/qr/871340

Notes for Table 4:

1. All device listed here must be disposed as e-waste upon its end of life according to local country guideline in each country.
2. For information on performance values at alternative drive conditions, please refer to the Product Selection Guide, Absolute Maximum Rating Table and Performance Curves in this data sheet.
3. For a definition of useful luminous flux (Φ_{use}), please see the ELR regulations at <https://tinyurl.com/4b6zvt4m>.
4. EPREL requires an arrow symbol containing the letter of the energy efficiency class to be displayed, on technical promotional material. Refer to this energy efficiency class column for specific energy efficiency class on each part number.

European Product Registry for Energy Labeling

Table 4: Part numbers registered in European Product Registry for Energy Labeling (Continued)

PART NUMBER ¹	CCT (K)	CRI	Current ² (mA)	Vf (V)	Useful flux ³ (Φ_{use}) at 85°C (lm)	Power (W)	Efficacy (lm/W)	Energy efficiency class ⁴	Registration No	URL to Product Information Sheet in EPREL Database
BXRC-30G10H0-B-7x	3000	90	540	35.1	2153	19.0	113	F	871421	https://eprelec.europa.eu/qr/871421
BXRC-30G10H0-C-7x	3000	90	720	35.1	2867	25.3	113	F	871425	https://eprelec.europa.eu/qr/871425
BXRC-30G10H0-D-7x	3000	90	700	27.7	2108	19.4	109	F	871429	https://eprelec.europa.eu/qr/871429
BXRC-30G1000-B-7x	3000	90	540	35.1	2063	19.0	109	F	871399	https://eprelec.europa.eu/qr/871399
BXRC-30G1000-C-7x	3000	90	720	35.1	2748	25.3	109	F	871404	https://eprelec.europa.eu/qr/871404
BXRC-30G1000-D-7x	3000	90	700	27.7	2020	19.4	104	F	871409	https://eprelec.europa.eu/qr/871409
BXRC-30G100C-B-7x	3000	90	540	35.1	2063	19.0	109	F	871413	https://eprelec.europa.eu/qr/871413
BXRC-30G100C-D-7x	3000	90	700	27.7	2020	19.4	104	F	871415	https://eprelec.europa.eu/qr/871415
BXRC-30H1000-B-7x	3000	95	500	34.7	1754	17.4	101	F	871531	https://eprelec.europa.eu/qr/871531
BXRC-30H1000-C-7x	3000	95	630	34.5	2229	21.7	103	F	871535	https://eprelec.europa.eu/qr/871535
BXRC-30H1000-D-7x	3000	95	590	27.0	1588	16.0	100	F	871539	https://eprelec.europa.eu/qr/871539
BXRC-30A1001-B-7x	3000	90	460	34.4	1624	15.8	103	F	871239	https://eprelec.europa.eu/qr/871239
BXRC-30A1001-C-7x	3000	90	570	34.0	2031	19.4	105	F	871240	https://eprelec.europa.eu/qr/871240
BXRC-30A1001-D-7x	3000	90	530	26.7	1437	14.1	102	F	871241	https://eprelec.europa.eu/qr/871241
BXRC-35E1000-B-7x	3500	80	540	35.1	2601	19.0	137	E	871604	https://eprelec.europa.eu/qr/871604
BXRC-35E1000-C-7x	3500	80	720	35.1	3464	25.3	137	E	871609	https://eprelec.europa.eu/qr/871609
BXRC-35E1000-D-7x	3500	80	700	27.7	2547	19.4	131	E	871614	https://eprelec.europa.eu/qr/871614
BXRC-35G1000-B-7x	3500	90	540	35.1	2138	19.0	113	F	871672	https://eprelec.europa.eu/qr/871672
BXRC-35G1000-C-7x	3500	90	720	35.1	2847	25.3	113	F	871677	https://eprelec.europa.eu/qr/871677
BXRC-35G1000-D-7x	3500	90	700	27.7	2094	19.4	108	F	871682	https://eprelec.europa.eu/qr/871682
BXRC-35A1001-B-7x	3500	90	540	35.1	1973	19.0	104	F	871585	https://eprelec.europa.eu/qr/871585
BXRC-35A1001-C-7x	3500	90	670	34.8	2477	23.3	106	F	871586	https://eprelec.europa.eu/qr/871586
BXRC-35A1001-D-7x	3500	90	620	27.2	1749	16.9	104	F	871587	https://eprelec.europa.eu/qr/871587
BXRC-40C1001-B-7x	4000	70	540	35.1	2736	19.0	144	E	871758	https://eprelec.europa.eu/qr/871758
BXRC-40C1001-C-7x	4000	70	720	35.1	3644	25.3	144	E	871764	https://eprelec.europa.eu/qr/871764
BXRC-40C1001-D-7x	4000	70	700	27.7	2679	19.4	138	E	871770	https://eprelec.europa.eu/qr/871770
BXRC-40E1000-B-7x	4000	80	540	35.1	2616	19.0	138	E	871836	https://eprelec.europa.eu/qr/871836
BXRC-40E1000-C-7x	4000	80	720	35.1	3484	25.3	138	E	871841	https://eprelec.europa.eu/qr/871841
BXRC-40E1000-D-7x	4000	80	700	27.7	2562	19.4	132	E	871846	https://eprelec.europa.eu/qr/871846
BXRC-40G1000-B-7x	4000	90	540	35.1	2183	19.0	115	F	871905	https://eprelec.europa.eu/qr/871905
BXRC-40G1000-C-7x	4000	90	720	35.1	2907	25.3	115	F	871910	https://eprelec.europa.eu/qr/871910
BXRC-40G1000-D-7x	4000	90	700	27.7	2137	19.4	110	F	871915	https://eprelec.europa.eu/qr/871915
BXRC-40H1000-B-7x	4000	95	540	35.1	1973	19.0	104	F	871970	https://eprelec.europa.eu/qr/871970
BXRC-40H1000-C-7x	4000	95	720	35.1	2628	25.3	104	F	871972	https://eprelec.europa.eu/qr/871972
BXRC-40H1000-D-7x	4000	95	670	27.5	1863	18.4	101	F	871974	https://eprelec.europa.eu/qr/871974

Notes for Table 4:

1. All device listed here must be disposed as e-waste upon its end of life according to local country guideline in each country.
2. For information on performance values at alternative drive conditions, please refer to the Product Selection Guide, Absolute Maximum Rating Table and Performance Curves in this data sheet.
3. For a definition of useful luminous flux (Φ_{use}), please see the ELR regulations at <https://tinyurl.com/4b6zvt4m>.
4. EPREL requires an arrow symbol containing the letter of the energy efficiency class to be displayed, on technical promotional material. Refer to this energy efficiency class column for specific energy efficiency class on each part number.

European Product Registry for Energy Labeling

Table 4: Part numbers registered in European Product Registry for Energy Labeling (Continued)

PART NUMBER ¹	CCT (K)	CRI	Current ² (mA)	V _f (V)	Useful flux ³ (Φ_{use}) at 85C (lm)	Power (W)	Efficacy (lm/W)	Energy efficiency class ⁴ 	Registration No	URL to Product Information Sheet in EPREL Database
BXRC-40A1001-B-7x	4000	90	540	35.1	2138	19.0	113	F	871740	https://eprelec.europa.eu/qr/871740
BXRC-40A1001-C-7x	4000	90	720	35.1	2847	25.3	113	F	871741	https://eprelec.europa.eu/qr/871741
BXRC-40A1001-D-7x	4000	90	700	27.7	2094	19.4	108	F	871742	https://eprelec.europa.eu/qr/871742
BXRC-50C1001-B-7x	5000	70	540	35.1	2751	19.0	145	E	871994	https://eprelec.europa.eu/qr/871994
BXRC-50C1001-C-7x	5000	70	720	35.1	3664	25.3	145	E	871998	https://eprelec.europa.eu/qr/871998
BXRC-50C1001-D-7x	5000	70	700	27.7	2694	19.4	139	E	872002	https://eprelec.europa.eu/qr/872002
BXRC-50E1001-B-7x	5000	80	540	35.1	2646	19.0	139	E	872046	https://eprelec.europa.eu/qr/872046
BXRC-50E1001-C-7x	5000	80	720	35.1	3524	25.3	139	E	872050	https://eprelec.europa.eu/qr/872050
BXRC-50E1001-D-7x	5000	80	700	27.7	2591	19.4	134	E	872054	https://eprelec.europa.eu/qr/872054
BXRC-50G1001-B-7x	5000	90	540	35.1	2287	19.0	121	E	872098	https://eprelec.europa.eu/qr/872098
BXRC-50G1001-C-7x	5000	90	720	35.1	3046	25.3	120	E	872102	https://eprelec.europa.eu/qr/872102
BXRC-50G1001-D-7x	5000	90	700	27.7	2240	19.4	116	F	872106	https://eprelec.europa.eu/qr/872106
BXRC-57C1001-B-7x	5700	70	540	35.1	2676	19.0	141	E	872204	https://eprelec.europa.eu/qr/872204
BXRC-57C1001-C-7x	5700	70	720	35.1	3564	25.3	141	E	872208	https://eprelec.europa.eu/qr/872208
BXRC-57C1001-D-7x	5700	70	700	27.7	2621	19.4	135	E	872212	https://eprelec.europa.eu/qr/872212
BXRC-57E1001-B-7x	5700	80	540	35.1	2542	19.0	134	E	872253	https://eprelec.europa.eu/qr/872253
BXRC-57E1001-C-7x	5700	80	720	35.1	3385	25.3	134	E	872257	https://eprelec.europa.eu/qr/872257
BXRC-57E1001-D-7x	5700	80	700	27.7	2489	19.4	128	E	872261	https://eprelec.europa.eu/qr/872261
BXRC-65C1001-B-7x	6500	70	540	35.1	2676	19.0	141	E	872301	https://eprelec.europa.eu/qr/872301
BXRC-65C1001-C-7x	6500	70	720	35.1	3564	25.3	141	E	872305	https://eprelec.europa.eu/qr/872305
BXRC-65C1001-D-7x	6500	70	700	27.7	2621	19.4	135	E	872309	https://eprelec.europa.eu/qr/872309
BXRC-65E1001-B-7x	6500	80	540	35.1	2572	19.0	136	E	872351	https://eprelec.europa.eu/qr/872351
BXRC-65E1001-C-7x	6500	80	720	35.1	3425	25.3	135	E	872355	https://eprelec.europa.eu/qr/872355
BXRC-65E1001-D-7x	6500	80	700	27.7	2518	19.4	130	E	872359	https://eprelec.europa.eu/qr/872359

Notes for Table 4:

1. All device listed here must be disposed as e-waste upon its end of life according to local country guideline in each country.
2. For information on performance values at alternative drive conditions, please refer to the Product Selection Guide, Absolute Maximum Rating Table and Performance Curves in this data sheet.
3. For a definition of useful luminous flux (Φ_{use}), please see the ELR regulations at <https://tinyurl.com/4b6zvt4m>.
4. EPREL requires an arrow symbol containing the letter of the energy efficiency class to be displayed, on technical promotional material. Refer to this energy efficiency class column for specific energy efficiency class on each part number.

Performance at Commonly Used Drive Currents

Vero LED arrays are tested to the specifications shown using the nominal drive currents in Table 1. Vero may also be driven at other drive currents dependent on specific application design requirements. The performance at any drive current can be derived from the current vs. voltage characteristics shown in Figures 1, 2 & 3 and the flux vs. current characteristics shown in Figures 4, 5 & 6. The performance at commonly used drive currents is summarized in Table 5.

Table 5: Product Performance at Commonly Used Drive Currents

Part Number	CRI	Drive Current ¹ (mA)	Typical V _f T _c = 25°C (V)	Typical Power T _c = 25°C (W)	Typical Flux ² T _c = 25°C (lm)	Typical DC Flux ³ T _c = 85°C (lm)	Typical Efficacy T _c = 25°C (lm/W)
BXRC-20B1001-B-7x	65	135	33.2	4.5	762	685	170
		180	34.0	6.1	1000	897	163
		270	34.8	9.4	1431	1288	152
		405	35.6	14.4	2099	1867	145
		540	36.1	19.5	2689	2380	138
BXRC-20B1001-D-7x	65	175	24.9	4.4	740	673	170
		233	25.4	5.9	971	873	164
		350	26.0	9.1	1386	1247	152
		525	27.4	14.4	2040	1759	142
		700	28.4	19.9	2613	2201	131
BXRC-27E1000-B-7x	80	135	33.2	4.5	777	698	173
		180	34.0	6.1	1019	914	166
		270	34.8	9.4	1458	1312	155
		405	35.6	14.4	2139	1903	148
		540	36.1	19.5	2741	2426	140
BXRC-27E1000-C-7x	80	180	33.2	6.0	1034	922	173
		240	34.0	8.2	1354	1203	166
		360	34.8	12.5	1944	1750	155
		540	35.6	19.2	2831	2460	147
		720	36.1	26.0	3617	3096	139
BXRC-27E1000-D-7x	80	175	24.9	4.4	754	686	173
		233	25.4	5.9	989	889	167
		350	26.0	9.1	1412	1271	155
		525	27.4	14.4	2079	1793	145
		700	28.4	19.9	2663	2243	134
BXRC-27G10H0-B-7x	90	135	33.2	4.5	665	598	148
		180	34.0	6.1	872	783	143
		270	34.8	9.4	1249	1124	133
		405	35.6	14.4	1832	1630	127
		540	36.1	19.5	2347	2077	120
BXRC-27G10H0-C-7x	90	180	33.2	6.0	885	790	148
		240	34.0	8.2	1160	1030	142
		360	34.8	12.5	1665	1498	133
		540	35.6	19.2	2424	2106	126
		720	36.1	26.0	3097	2651	119
BXRC-27G10H0-D-7x	90	175	24.9	4.4	646	587	148
		233	25.4	5.9	847	762	143
		350	26.0	9.1	1209	1088	133
		525	27.4	14.4	1780	1535	124
		700	28.4	19.9	2280	1920	115

Notes for Table 5:

1. Alternate drive currents are provided for reference only and are not a guarantee of performance.
2. Bridgelux maintains a ± 7% tolerance on flux measurements.
3. Typical stabilized DC performance values are provided as reference only and are not a guarantee of performance.

Performance at Commonly Used Drive Currents

Table 5: Product Performance at Commonly Used Drive Currents (Continued)

Part Number	CRI	Drive Current ¹ (mA)	Typical V _f T _c = 25°C (V)	Typical Power T _c = 25°C (W)	Typical Flux ² T _c = 25°C (lm)	Typical DC Flux ³ T _c = 85°C (lm)	Typical Efficacy T _c = 25°C (lm/W)
BXRC-27G1000-B-7x	90	135	33.2	4.5	641	576	143
		180	34.0	6.1	841	754	137
		270	34.8	9.4	1203	1083	128
		405	35.6	14.4	1765	1570	122
		540	36.1	19.5	2261	2001	116
BXRC-27G1000-C-7x	90	180	33.2	6.0	853	761	143
		240	34.0	8.2	1117	993	137
		360	34.8	12.5	1604	1444	128
		540	35.6	19.2	2336	2029	121
		720	36.1	26.0	2984	2554	115
BXRC-27G1000-D-7x	90	175	24.9	4.4	622	566	143
		233	25.4	5.9	816	734	138
		350	26.0	9.1	1165	1049	128
		525	27.4	14.4	1715	1479	119
		700	28.4	19.9	2197	1850	110
BXRC-27H1000-B-7x	97	135	33.2	4.5	568	511	127
		180	34.0	6.1	745	668	122
		270	34.8	9.4	1066	960	113
		405	35.6	14.4	1564	1392	108
		540	36.1	19.5	2004	1774	103
BXRC-27H1000-C-7x	97	180	33.2	6.0	756	675	126
		240	34.0	8.2	990	880	121
		360	34.8	12.5	1422	1280	113
		540	35.6	19.2	2070	1799	108
		720	36.1	26.0	2645	2264	102
BXRC-27H1000-D-7x	97	175	24.9	4.4	551	501	126
		233	25.4	5.9	723	650	122
		350	26.0	9.1	1033	929	113
		525	27.4	14.4	1520	1311	106
		700	28.4	19.9	1948	1640	98
BXRC-30C1001-B-7x	70	135	33.2	4.5	864	777	193
		180	34.0	6.1	1134	1017	185
		270	34.8	9.4	1622	1460	173
		405	35.6	14.4	2380	2117	165
		540	36.1	19.5	3049	2699	156
BXRC-30C1001-C-7x	70	180	33.2	6.0	1150	1026	192
		240	34.0	8.2	1507	1338	185
		360	34.8	12.5	2163	1947	173
		540	35.6	19.2	3150	2736	164
		720	36.1	26.0	4023	3444	155
BXRC-30C1001-D-7x	70	175	24.9	4.4	839	763	192
		233	25.4	5.9	1101	990	186
		350	26.0	9.1	1571	1414	173
		525	27.4	14.4	2313	1995	161
		700	28.4	19.9	2963	2495	149

Notes for Table 5:

1. Alternate drive currents are provided for reference only and are not a guarantee of performance.
2. Bridgelux maintains a ± 7% tolerance on flux measurements.
3. Typical stabilized DC performance values are provided as reference only and are not a guarantee of performance.

Performance at Commonly Used Drive Currents

Table 5: Product Performance at Commonly Used Drive Currents (Continued)

Part Number	CRI	Drive Current ¹ (mA)	Typical V _f T _c = 25°C (V)	Typical Power T _c = 25°C (W)	Typical Flux ² T _c = 25°C (lm)	Typical DC Flux ³ T _c = 85°C (lm)	Typical Efficacy T _c = 25°C (lm/W)
BXRC-30E1000-B-7x	80	135	33.2	4.5	826	742	184
		180	34.0	6.1	1083	971	177
		270	34.8	9.4	1549	1394	165
		405	35.6	14.4	2273	2022	157
		540	36.1	19.5	2912	2577	149
BXRC-30E1000-C-7x	80	180	33.2	6.0	1098	980	184
		240	34.0	8.2	1439	1278	176
		360	34.8	12.5	2066	1859	165
		540	35.6	19.2	3008	2613	156
BXRC-30E1000-D-7x	80	720	36.1	26.0	3843	3289	148
		175	24.9	4.4	801	729	184
		233	25.4	5.9	1051	945	178
		350	26.0	9.1	1501	1351	165
BXRC-30E1000-D-7x	80	525	27.4	14.4	2209	1905	154
		700	28.4	19.9	2830	2383	142
		135	33.2	4.5	699	628	156
		180	34.0	6.1	917	823	150
BXRC-30G10H0-B-7x	90	270	34.8	9.4	1312	1181	140
		405	35.6	14.4	1925	1713	133
		540	36.1	19.5	2467	2183	126
		180	33.2	6.0	930	830	156
BXRC-30G10H0-C-7x	90	240	34.0	8.2	1219	1083	149
		360	34.8	12.5	1750	1575	140
		540	35.6	19.2	2548	2214	132
		720	36.1	26.0	3255	2786	125
BXRC-30G10H0-D-7x	90	175	24.9	4.4	679	617	156
		233	25.4	5.9	890	801	150
		350	26.0	9.1	1271	1144	140
		525	27.4	14.4	1871	1614	130
BXRC-30G10H0-D-7x	90	700	28.4	19.9	2397	2018	121
		135	33.2	4.5	670	602	149
		180	34.0	6.1	879	788	144
		270	34.8	9.4	1258	1132	134
BXRC-30G1000-B-7x	90	405	35.6	14.4	1845	1641	128
		540	36.1	19.5	2364	2092	121
		180	33.2	6.0	892	796	149
		240	34.0	8.2	1168	1038	143
BXRC-30G1000-C-7x	90	360	34.8	12.5	1677	1509	134
		540	35.6	19.2	2442	2121	127
		720	36.1	26.0	3119	2670	120
		175	24.9	4.4	650	591	149
BXRC-30G1000-D-7x	90	233	25.4	5.9	853	767	144
		350	26.0	9.1	1218	1096	134
		525	27.4	14.4	1793	1546	125
		700	28.4	19.9	2297	1934	115

Notes for Table 5:

1. Alternate drive currents are provided for reference only and are not a guarantee of performance.
2. Bridgelux maintains a ± 7% tolerance on flux measurements.
3. Typical stabilized DC performance values are provided as reference only and are not a guarantee of performance.

Performance at Commonly Used Drive Currents

Table 5: Product Performance at Commonly Used Drive Currents (Continued)

Part Number	CRI	Drive Current ¹ (mA)	Typical V_f $T_c = 25^\circ\text{C}$ (V)	Typical Power $T_c = 25^\circ\text{C}$ (W)	Typical Flux ² $T_c = 25^\circ\text{C}$ (lm)	Typical DC Flux ³ $T_c = 85^\circ\text{C}$ (lm)	Typical Efficacy $T_c = 25^\circ\text{C}$ (lm/W)
BXRC-30G100C-B-7x	90	135	33.2	4.5	646	580	144
		180	34.0	6.1	847	760	138
		270	34.8	9.4	1212	1091	129
		405	35.6	14.4	1778	1582	123
		540	36.1	19.5	2278	2016	117
BXRC-30G100C-D-7x	90	175	24.9	4.4	627	570	144
		233	25.4	5.9	822	739	139
		350	26.0	9.1	1174	1057	129
		525	27.4	14.4	1728	1490	120
		700	28.4	19.9	2214	1864	111
BXRC-30H1000-B-7x	97	135	33.2	4.5	607	546	135
		180	34.0	6.1	796	714	130
		270	34.8	9.4	1139	1025	121
		405	35.6	14.4	1671	1487	116
		540	36.1	19.5	2141	1895	110
BXRC-30H1000-C-7x	97	180	33.2	6.0	808	721	135
		240	34.0	8.2	1058	940	130
		360	34.8	12.5	1519	1367	121
		540	35.6	19.2	2212	1922	115
		720	36.1	26.0	2825	2419	109
BXRC-30H1000-D-7x	97	175	24.9	4.4	589	536	135
		233	25.4	5.9	773	695	131
		350	26.0	9.1	1103	993	121
		525	27.4	14.4	1624	1401	113
		700	28.4	19.9	2081	1752	105
BXRC-30A1001-B-7x	93	135	33.2	4.5	602	541	134
		180	34.0	6.1	790	708	129
		270	34.8	9.4	1130	1017	120
		405	35.6	14.4	1658	1475	115
		540	36.1	19.5	2124	1880	109
BXRC-30A1001-C-7x	93	180	33.2	6.0	801	715	134
		240	34.0	8.2	1050	932	129
		360	34.8	12.5	1507	1356	120
		540	35.6	19.2	2194	1906	114
		720	36.1	26.0	2803	2399	108
BXRC-30A1001-D-7x	93	175	24.9	4.4	584	531	134
		233	25.4	5.9	767	689	130
		350	26.0	9.1	1095	985	120
		525	27.4	14.4	1611	1390	112
		700	28.4	19.9	2064	1738	104
BXRC-35E1000-B-7x	80	135	33.2	4.5	845	759	188
		180	34.0	6.1	1108	994	181
		270	34.8	9.4	1586	1427	169
		405	35.6	14.4	2327	2070	161
		540	36.1	19.5	2981	2638	153

Notes for Table 5:

1. Alternate drive currents are provided for reference only and are not a guarantee of performance.
2. Bridgelux maintains a $\pm 7\%$ tolerance on flux measurements.
3. Typical stabilized DC performance values are provided as reference only and are not a guarantee of performance.

Performance at Commonly Used Drive Currents

Table 5: Product Performance at Commonly Used Drive Currents (Continued)

Part Number	CRI	Drive Current ¹ (mA)	Typical V_f $T_c = 25^\circ\text{C}$ (V)	Typical Power $T_c = 25^\circ\text{C}$ (W)	Typical Flux ² $T_c = 25^\circ\text{C}$ (lm)	Typical DC Flux ³ $T_c = 85^\circ\text{C}$ (lm)	Typical Efficacy $T_c = 25^\circ\text{C}$ (lm/W)
BXRC-35E1000-C-7x	80	180	33.2	6.0	1124	1003	188
		240	34.0	8.2	1473	1308	180
		360	34.8	12.5	2114	1903	169
		540	35.6	19.2	3079	2675	160
BXRC-35E1000-D-7x	80	720	36.1	26.0	3933	3367	151
		175	24.9	4.4	820	746	188
		233	25.4	5.9	1076	967	182
		350	26.0	9.1	1536	1382	169
BXRC-35G1000-B-7x	90	525	27.4	14.4	2261	1950	157
		700	28.4	19.9	2896	2439	146
		135	33.2	4.5	695	624	155
		180	34.0	6.1	911	817	149
BXRC-35G1000-C-7x	90	270	34.8	9.4	1303	1173	139
		405	35.6	14.4	1912	1701	132
		540	36.1	19.5	2450	2168	126
		180	33.2	6.0	924	824	155
BXRC-35G1000-D-7x	90	240	34.0	8.2	1210	1075	148
		350	26.0	9.1	1262	1136	139
		525	27.4	14.4	1858	1602	129
		700	28.4	19.9	2380	2004	120
BXRC-35A1001-B-7x	93	135	33.2	4.5	641	576	143
		180	34.0	6.1	841	754	137
		270	34.8	9.4	1203	1083	128
		405	35.6	14.4	1765	1570	122
BXRC-35A1001-C-7x	93	540	36.1	19.5	2261	2001	116
		180	33.2	6.0	853	761	143
		240	34.0	8.2	1117	993	137
		360	34.8	12.5	1604	1444	128
BXRC-35A1001-D-7x	93	540	35.6	19.2	2336	2029	121
		720	36.1	26.0	2984	2554	115
		175	24.9	4.4	622	566	143
		233	25.4	5.9	816	734	138
BXRC-40C1001-B-7x	70	350	26.0	9.1	1165	1049	128
		525	27.4	14.4	1715	1479	119
		700	28.4	19.9	2197	1850	110
		135	33.2	4.5	889	799	198
BXRC-40C1001-B-7x	70	180	34.0	6.1	1165	1045	190
		270	34.8	9.4	1668	1501	178
		405	35.6	14.4	2447	2177	170
		540	36.1	19.5	3135	2775	161

Notes for Table 5:

1. Alternate drive currents are provided for reference only and are not a guarantee of performance.
2. Bridgelux maintains a $\pm 7\%$ tolerance on flux measurements.
3. Typical stabilized DC performance values are provided as reference only and are not a guarantee of performance.

Performance at Commonly Used Drive Currents

Table 5: Product Performance at Commonly Used Drive Currents (Continued)

Part Number	CRI	Drive Current ¹ (mA)	Typical V _f T _c = 25°C (V)	Typical Power T _c = 25°C (W)	Typical Flux ² T _c = 25°C (lm)	Typical DC Flux ³ T _c = 85°C (lm)	Typical Efficacy T _c = 25°C (lm/W)
BXRC-40C1001-C-7x	70	180	33.2	6.0	1182	1055	198
		240	34.0	8.2	1549	1376	190
		360	34.8	12.5	2224	2001	178
		540	35.6	19.2	3238	2813	168
BXRC-40C1001-D-7x	70	720	36.1	26.0	4136	3541	159
		175	24.9	4.4	862	784	198
		233	25.4	5.9	1131	1017	191
		350	26.0	9.1	1615	1454	178
BXRC-40E1000-B-7x	80	525	27.4	14.4	2378	2051	165
		700	28.4	19.9	3046	2565	153
		135	33.2	4.5	850	764	190
		180	34.0	6.1	1114	1000	182
BXRC-40E1000-C-7x	80	270	34.8	9.4	1595	1435	170
		405	35.6	14.4	2340	2082	162
		540	36.1	19.5	2998	2653	154
		180	33.2	6.0	1131	1009	189
BXRC-40E1000-D-7x	80	240	34.0	8.2	1481	1316	181
		350	26.0	9.1	1545	1390	170
		525	27.4	14.4	2274	1961	158
		700	28.4	19.9	2913	2453	146
BXRC-40G1000-B-7x	90	135	33.2	4.5	709	637	158
		180	34.0	6.1	930	834	152
		270	34.8	9.4	1331	1198	142
		405	35.6	14.4	1952	1737	135
BXRC-40G1000-C-7x	90	540	36.1	19.5	2501	2214	128
		180	33.2	6.0	943	842	158
		240	34.0	8.2	1236	1098	151
		360	34.8	12.5	1774	1597	142
BXRC-40G1000-D-7x	90	540	35.6	19.2	2584	2244	134
		720	36.1	26.0	3300	2825	127
		175	24.9	4.4	688	626	158
		233	25.4	5.9	903	812	153
BXRC-40H1000-B-7x	97	350	26.0	9.1	1289	1160	142
		525	27.4	14.4	1897	1636	132
		700	28.4	19.9	2430	2047	122
		135	33.2	4.5	641	576	143
BXRC-40H1000-C-7x	97	180	34.0	6.1	841	754	137
		270	34.8	9.4	1203	1083	128
		405	35.6	14.4	1765	1570	122
		540	36.1	19.5	2261	2001	116

Notes for Table 5:

1. Alternate drive currents are provided for reference only and are not a guarantee of performance.
2. Bridgelux maintains a ± 7% tolerance on flux measurements.
3. Typical stabilized DC performance values are provided as reference only and are not a guarantee of performance.

Performance at Commonly Used Drive Currents

Table 5: Product Performance at Commonly Used Drive Currents (Continued)

Part Number	CRI	Drive Current ¹ (mA)	Typical V_f $T_c = 25^\circ\text{C}$ (V)	Typical Power $T_c = 25^\circ\text{C}$ (W)	Typical Flux ² $T_c = 25^\circ\text{C}$ (lm)	Typical DC Flux ³ $T_c = 85^\circ\text{C}$ (lm)	Typical Efficacy $T_c = 25^\circ\text{C}$ (lm/W)
BXRC-40H1000-C-7x	97	180	33.2	6.0	853	761	143
		240	34.0	8.2	1117	993	137
		360	34.8	12.5	1604	1444	128
		540	35.6	19.2	2336	2029	121
BXRC-40H1000-D-7x	97	720	36.1	26.0	2984	2554	115
		175	24.9	4.4	622	566	143
		233	25.4	5.9	816	734	138
		350	26.0	9.1	1165	1049	128
BXRC-40A1001-B-7x	93	525	27.4	14.4	1715	1479	119
		700	28.4	19.9	2197	1850	110
		135	33.2	4.5	695	624	155
		180	34.0	6.1	911	817	149
BXRC-40A1001-C-7x	93	270	34.8	9.4	1303	1173	139
		405	35.6	14.4	1912	1701	132
		540	36.1	19.5	2450	2168	126
		180	33.2	6.0	924	824	155
BXRC-40A1001-D-7x	93	240	34.0	8.2	1210	1075	148
		350	26.0	9.1	1262	1136	139
		525	27.4	14.4	1858	1602	129
		700	28.4	19.9	2380	2004	120
BXRC-50C1001-B-7x	70	135	33.2	4.5	894	803	199
		180	34.0	6.1	1172	1051	191
		270	34.8	9.4	1677	1509	178
		405	35.6	14.4	2460	2189	170
BXRC-50C1001-C-7x	70	540	36.1	19.5	3152	2790	161
		180	33.2	6.0	1189	1061	199
		240	34.0	8.2	1557	1384	191
		360	34.8	12.5	2236	2012	178
BXRC-50C1001-D-7x	70	540	35.6	19.2	3256	2828	169
		720	36.1	26.0	4159	3560	160
		175	24.9	4.4	867	789	199
		233	25.4	5.9	1138	1023	192
BXRC-50E1001-B-7x	80	350	26.0	9.1	1624	1462	178
		525	27.4	14.4	2391	2062	166
		700	28.4	19.9	3063	2579	154
		135	33.2	4.5	860	773	192
BXRC-50E1001-C-7x	80	180	34.0	6.1	1127	1011	184
		270	34.8	9.4	1613	1452	172
		405	35.6	14.4	2367	2105	164
		540	36.1	19.5	3032	2684	155

Notes for Table 5:

1. Alternate drive currents are provided for reference only and are not a guarantee of performance.
2. Bridgelux maintains a $\pm 7\%$ tolerance on flux measurements.
3. Typical stabilized DC performance values are provided as reference only and are not a guarantee of performance.

Performance at Commonly Used Drive Currents

Table 5: Product Performance at Commonly Used Drive Currents (Continued)

Part Number	CRI	Drive Current ¹ (mA)	Typical V _f T _c = 25°C (V)	Typical Power T _c = 25°C (W)	Typical Flux ² T _c = 25°C (lm)	Typical DC Flux ³ T _c = 85°C (lm)	Typical Efficacy T _c = 25°C (lm/W)
BXRC-50E1001-C-7x	80	180	33.2	6.0	1144	1020	191
		240	34.0	8.2	1498	1331	184
		360	34.8	12.5	2151	1936	172
		540	35.6	19.2	3132	2721	163
		720	36.1	26.0	4001	3425	154
BXRC-50E1001-D-7x	80	175	24.9	4.4	834	759	191
		233	25.4	5.9	1094	984	185
		350	26.0	9.1	1562	1406	172
		525	27.4	14.4	2300	1983	160
		700	28.4	19.9	2946	2481	148
BXRC-50G1001-B-7x	90	135	33.2	4.5	743	668	166
		180	34.0	6.1	974	874	159
		270	34.8	9.4	1394	1255	148
		405	35.6	14.4	2046	1820	142
		540	36.1	19.5	2621	2320	134
BXRC-50G1001-C-7x	90	180	33.2	6.0	989	882	165
		240	34.0	8.2	1295	1150	159
		360	34.8	12.5	1859	1673	148
		540	35.6	19.2	2707	2352	141
		720	36.1	26.0	3458	2960	133
BXRC-50G1001-D-7x	90	175	24.9	4.4	721	656	165
		233	25.4	5.9	946	851	160
		350	26.0	9.1	1351	1215	148
		525	27.4	14.4	1988	1714	138
		700	28.4	19.9	2547	2145	128
BXRC-57C1001-B-7x	70	135	33.2	4.5	869	781	194
		180	34.0	6.1	1140	1022	186
		270	34.8	9.4	1631	1468	174
		405	35.6	14.4	2393	2129	166
		540	36.1	19.5	3066	2714	157
BXRC-57C1001-C-7x	70	180	33.2	6.0	1156	1032	193
		240	34.0	8.2	1515	1346	186
		360	34.8	12.5	2175	1958	174
		540	35.6	19.2	3167	2752	165
		720	36.1	26.0	4046	3463	155
BXRC-57C1001-D-7x	70	175	24.9	4.4	844	767	193
		233	25.4	5.9	1107	995	187
		350	26.0	9.1	1580	1422	174
		525	27.4	14.4	2326	2006	162
		700	28.4	19.9	2980	2509	150
BXRC-57E1001-B-7x	80	135	33.2	4.5	826	742	184
		180	34.0	6.1	1083	971	177
		270	34.8	9.4	1549	1394	165
		405	35.6	14.4	2273	2022	157
		540	36.1	19.5	2912	2577	149

Notes for Table 5:

1. Alternate drive currents are provided for reference only and are not a guarantee of performance.
2. Bridgelux maintains a ± 7% tolerance on flux measurements.
3. Typical stabilized DC performance values are provided as reference only and are not a guarantee of performance.

Performance at Commonly Used Drive Currents

Table 5: Product Performance at Commonly Used Drive Currents (Continued)

Part Number	CRI	Drive Current ¹ (mA)	Typical V_f $T_c = 25^\circ\text{C}$ (V)	Typical Power $T_c = 25^\circ\text{C}$ (W)	Typical Flux ² $T_c = 25^\circ\text{C}$ (lm)	Typical DC Flux ³ $T_c = 85^\circ\text{C}$ (lm)	Typical Efficacy $T_c = 25^\circ\text{C}$ (lm/W)
BXRC-57E1001-C-7x	80	180	33.2	6.0	1098	980	184
		240	34.0	8.2	1439	1278	176
		360	34.8	12.5	2066	1859	165
		540	35.6	19.2	3008	2613	156
BXRC-57E1001-D-7x	80	720	36.1	26.0	3843	3289	148
		175	24.9	4.4	801	729	184
		233	25.4	5.9	1051	945	178
		350	26.0	9.1	1501	1351	165
BXRC-65C1001-B-7x	70	525	27.4	14.4	2209	1905	154
		700	28.4	19.9	2830	2383	142
		135	33.2	4.5	869	781	194
		180	34.0	6.1	1140	1022	186
BXRC-65C1001-C-7x	70	270	34.8	9.4	1631	1468	174
		405	35.6	14.4	2393	2129	166
		540	36.1	19.5	3066	2714	157
		180	33.2	6.0	1156	1032	193
BXRC-65C1001-D-7x	70	240	34.0	8.2	1515	1346	186
		350	26.0	9.1	1580	1422	174
		525	27.4	14.4	2326	2006	162
		700	28.4	19.9	2980	2509	150
BXRC-65E1001-B-7x	80	135	33.2	4.5	835	751	186
		180	34.0	6.1	1095	982	179
		270	34.8	9.4	1568	1411	167
		405	35.6	14.4	2300	2046	159
BXRC-65E1001-C-7x	80	540	36.1	19.5	2946	2608	151
		180	33.2	6.0	1111	992	186
		240	34.0	8.2	1456	1293	178
		360	34.8	12.5	2090	1881	167
BXRC-65E1001-D-7x	80	540	35.6	19.2	3044	2644	158
		720	36.1	26.0	3888	3328	149
		175	24.9	4.4	811	737	186
		233	25.4	5.9	1063	956	180
BXRC-65E1001-D-7x	80	350	26.0	9.1	1518	1366	167
		525	27.4	14.4	2235	1927	155
		700	28.4	19.9	2863	2411	144

Notes for Table 5:

1. Alternate drive currents are provided for reference only and are not a guarantee of performance.
2. Bridgelux maintains a $\pm 7\%$ tolerance on flux measurements.
3. Typical stabilized DC performance values are provided as reference only and are not a guarantee of performance.

Electrical Characteristics

Table 6: Electrical Characteristics

Part Number	Drive Current (mA)	Forward Voltage Pulsed, $T_c = 25^\circ\text{C}$ (V) ^{1, 2, 3, 8}			Typical Coefficient of Forward Voltage ⁴ $\Delta V_f / \Delta T_c$ (mV/ $^\circ\text{C}$)	Typical Thermal Resistance Junction to Case ^{5,6} R_{j-c} ($^\circ\text{C}/\text{W}$)	Driver Selection Voltages ⁷ (V)	
		Minimum	Typical	Maximum			V_f Min. Hot $T_c = 105^\circ\text{C}$ (V)	V_f Max. Cold $T_c = -40^\circ\text{C}$ (V)
BXRC-xxx100x-B-7x	270	32.2	34.8	37.4	-16.1	0.49	30.9	38.5
	540	33.4	36.1	38.8	-16.1	0.56	32.1	39.9
BXRC-xxx100x-C-7x	360	32.2	34.8	37.4	-16.1	0.37	30.9	38.5
	720	33.4	36.1	38.8	-16.1	0.45	32.1	39.9
BXRC-xxx100x-D-7x	350	24.1	26.0	28.0	-11.8	0.49	23.1	28.7
	700	26.3	28.4	30.5	-11.8	0.57	25.3	31.3

Notes for Table 6:

- Parts are tested in pulsed conditions, $T_c = 25^\circ\text{C}$. Pulse width is 10ms.
- Voltage minimum and maximum are provided for reference only and are not a guarantee of performance.
- Bridgelux maintains a tester tolerance of $\pm 0.10\text{V}$ on forward voltage measurements.
- Typical coefficient of forward voltage tolerance is $\pm 0.1\text{mV}$ for nominal current.
- Thermal resistance values are based from test data of a 3000K 80 CRI product.
- Thermal resistance value was calculated using total electrical input power; optical power was not subtracted from input power. The thermal interface material used during testing is not included in the thermal resistance value.
- V_f min hot and max cold values are provided as reference only and are not guaranteed by test. These values are provided to aid in driver design and selection over the operating range of the product.
- This product has been designed and manufactured per IEC 62031:2018. This product has passed dielectric withstand voltage testing at 1160 V. The working voltage designated for the insulation is 80V d.c. The maximum allowable voltage across the array must be determined in the end product application.

Eye Safety

Table 7: Eye Safety Risk Group (RG) Classifications

Part Number	Drive Current ⁵ (mA)	CCT ^{1,5}			
		2700K/3000K	4000K ²	5000K ³	6500K ⁴
BXRC-xxx100x-B-7x	270	RG1	RG1	RG1	RG1
	405	RG1	RG1	RG1	RG2
	540	RG1	RG1	RG2	RG2
BXRC-xxx100x-C-7x	360	RG1	RG1	RG1	RG2
	540	RG1	RG1	RG2	RG2
	720	RG1	RG2	RG2	RG2
BXRC-xxx100x-D-7x	350	RG1	RG1	RG1	RG1
	525	RG1	RG1	RG1	RG2
	700	RG1	RG1	RG2	RG2

Notes for Table 7:

1. Eye safety classification for the use of Bridgelux Vero Series LED arrays is in accordance with specification IEC/TR 62778: Application of IEC 62471 for the assessment of blue light hazard to light sources and luminaires.
2. For products classified as RG2 at 4000K, $E_{thr} = 1847.5$ lx.
3. For products classified as RG2 at 5000K $E_{thr} = 1315.8$ lx.
4. For products classified as RG2 at 6500K, $E_{thr} = 1124.5$ lx.
5. Please contact your Bridgelux sales representative for E_{thr} values at specific drive currents and CCTs not listed.

Absolute Maximum Ratings

Table 8: Maximum Ratings

Parameter	Maximum Rating		
LED Junction Temperature (T_j)	150°C		
Storage Temperature	-40°C to +105°C		
Operating Case Temperature ¹ (T_c)	105°C		
Soldering Temperature ²	300°C or lower for a maximum of 6 seconds		
	BXRC-xxx100x-B-7x	BXRC-xxx100x-C-7x	BXRC-xxx100x-D-7x
Maximum Drive Current ³	540mA	720mA	700mA
Maximum Peak Pulsed Drive Current ⁴	770mA	1030mA	1000mA
Maximum Reverse Voltage ⁵	-60V	-60V	-45V

Notes for Table 8:

1. For IEC 62717 requirement, please consult your Bridgelux sales representative.
2. Refer to Bridgelux Application Note AN31: Assembly Considerations for Bridgelux Vero LED Arrays.
3. Arrays may be driven at higher currents however lumen maintenance may be reduced.
4. Bridgelux recommends a maximum duty cycle of 10% and pulse width of 20 ms when operating LED Arrays at maximum peak pulsed current specified. Maximum peak pulsed currents indicate values where LED Arrays can be driven without catastrophic failures.
5. Light emitting diodes are not designed to be driven in reverse voltage and will not produce light under this condition. Maximum rating provided for reference only.

Performance Curves

Figure 1: Vero 10B Drive Current vs. Voltage

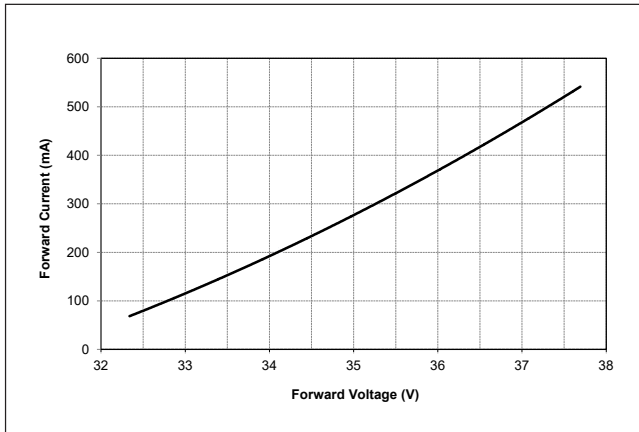

Figure 2: Vero 10C Drive Current vs. Voltage

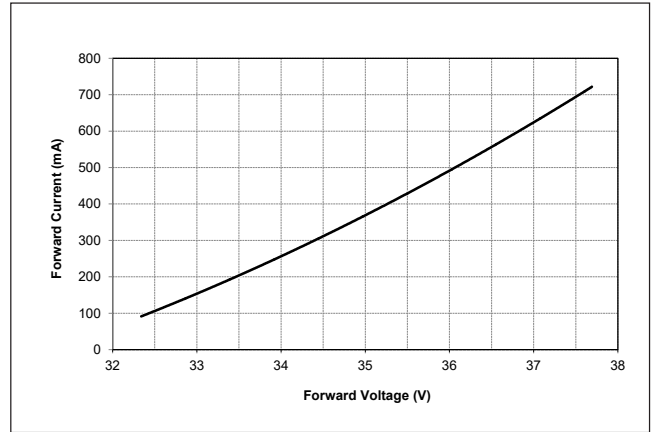

Figure 3: Vero 10D Drive Current vs. Voltage

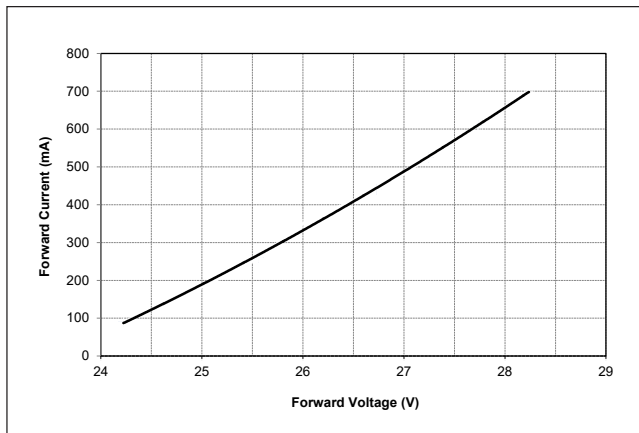

Figure 4: Vero 10B Typical Relative Flux vs. Current

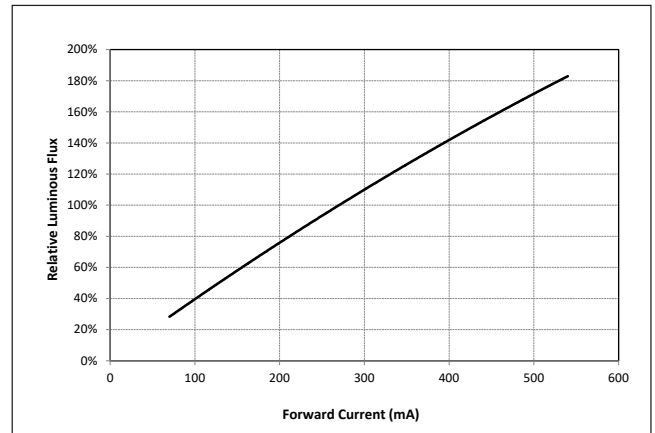

Figure 5: Vero 10C Typical Relative Flux vs. Current

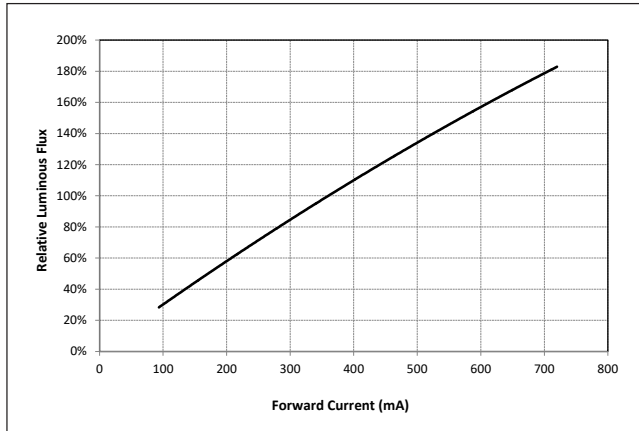
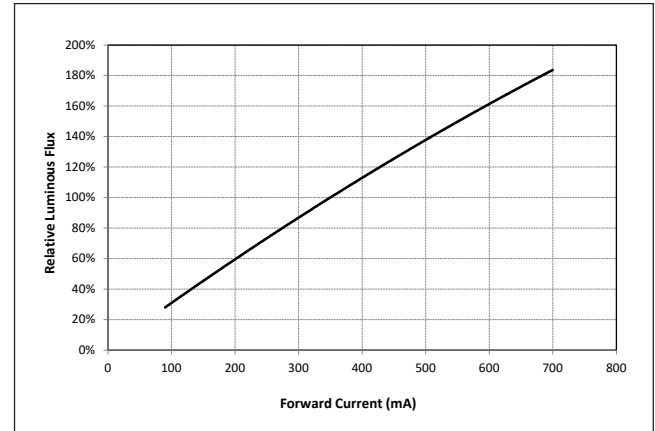

Figure 6: Vero 10D Typical Relative Flux vs. Current



Notes for Figures 1-6:

1. Bridgelux does not recommend driving high power LEDs at low currents. Doing so may produce unpredictable results. Pulse width modulation (PWM) is recommended for dimming effects.
2. Products tested under pulsed condition (10ms pulse width) at nominal test current where T_j (junction temperature) = T_c (case temperature) = 25°C.

Performance Curves

Figure 7: Typical DC Flux vs. Case Temperature

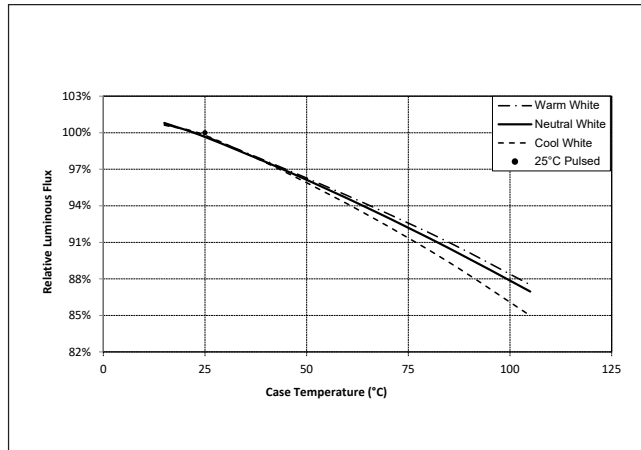

Figure 8: Typical DC ccy Shift vs. Case Temperature

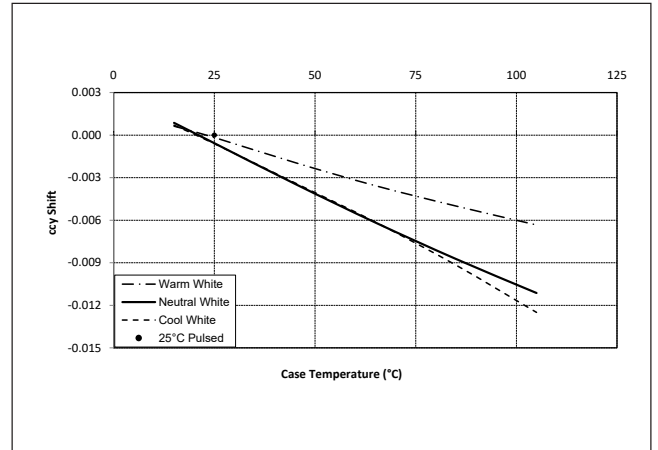

Figure 9: Typical DC ccx Shift vs. Case Temperature

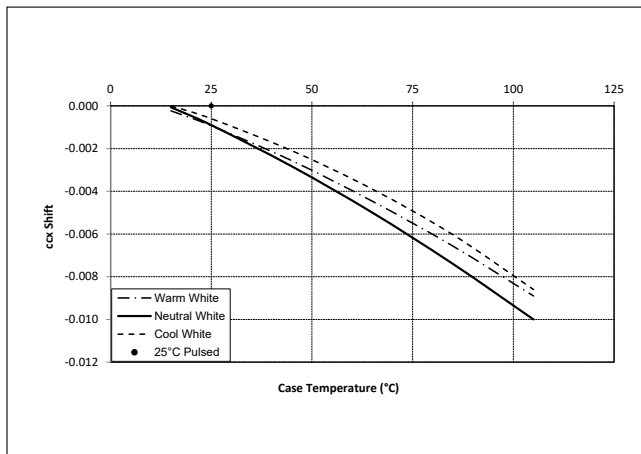
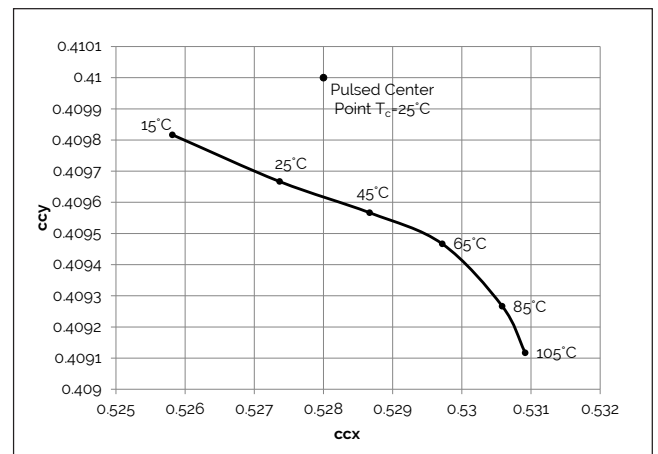

Figure 10: 2000K, 65 CRI Color Shift vs. Case Temperature



Notes for Figures 7 - 9:

1. Characteristics shown for warm white based on 3000K and 80 CRI.
2. Characteristics shown for neutral white based on 4000K and 80 CRI.
3. Characteristics shown for cool white based on 5000K and 70 CRI.
4. For other color SKUs, the shift in color will vary. Please contact your Bridgelux Sales Representative for more information.

Performance Curves

Figure 11: 2700K, 97 CRI Color Shift vs. Case Temperature¹

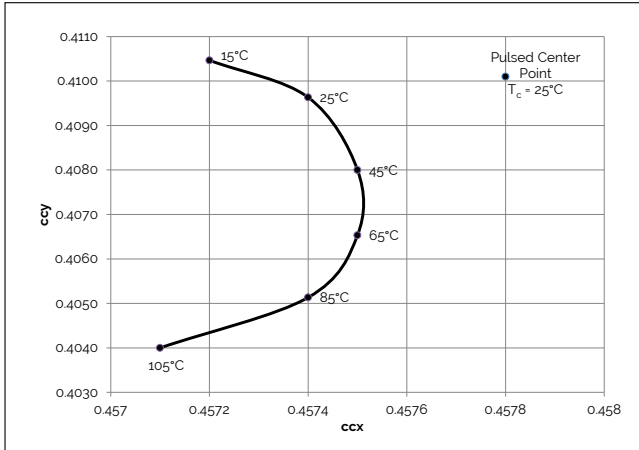

Figure 12: 3000K, 97 CRI Color Shift vs. Case Temperature¹

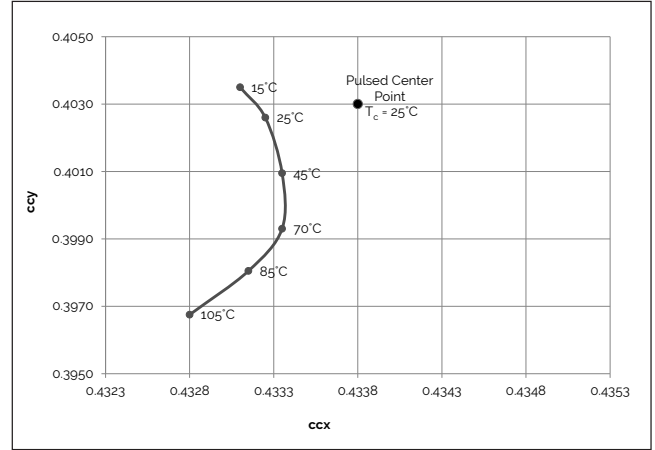

Figure 13: 3000K, 90 CRI Color Shift vs. Case Temperature³

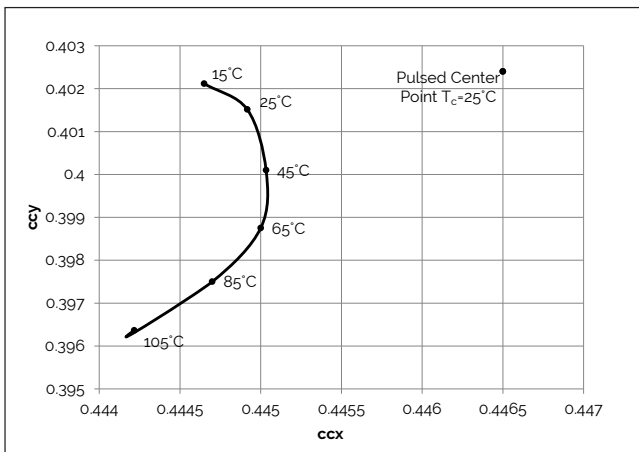

Figure 14: 3000K Class A Color Shift vs. Case Temperature¹

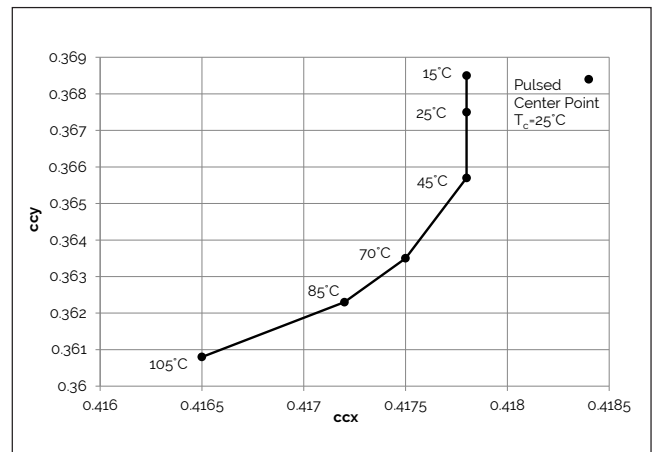

Figure 15: 3500K Class A Color Shift vs. Case Temperature¹

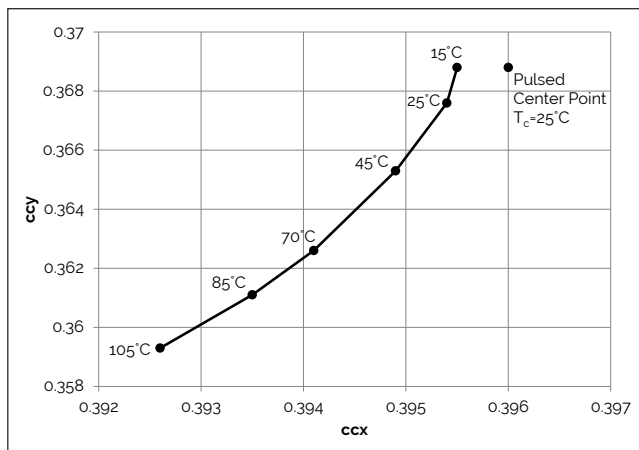
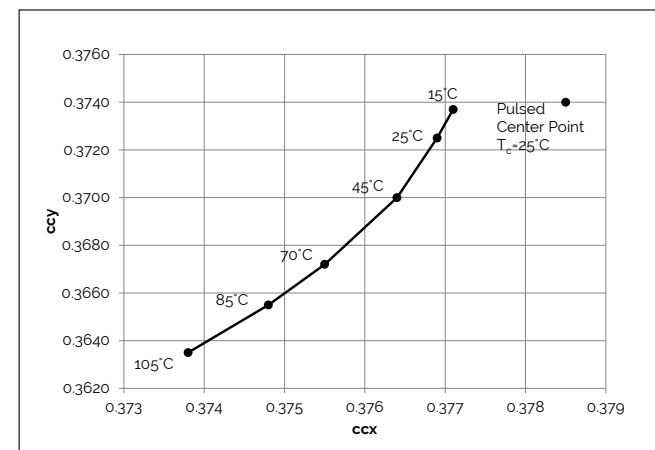

Figure 16: 4000K Class A Color Shift vs. Case Temperature¹



Notes for Figures 10-16:

1. Measurements made under DC test conditions at the nominal drive current.
2. Typical color shift is shown with a tolerance of ± 0.002 .
3. Characteristics shown for Decor Series Showcase products, BXRC-30G100C-x-73

Typical Radiation Pattern

Figure 17: Typical Spatial Radiation Pattern

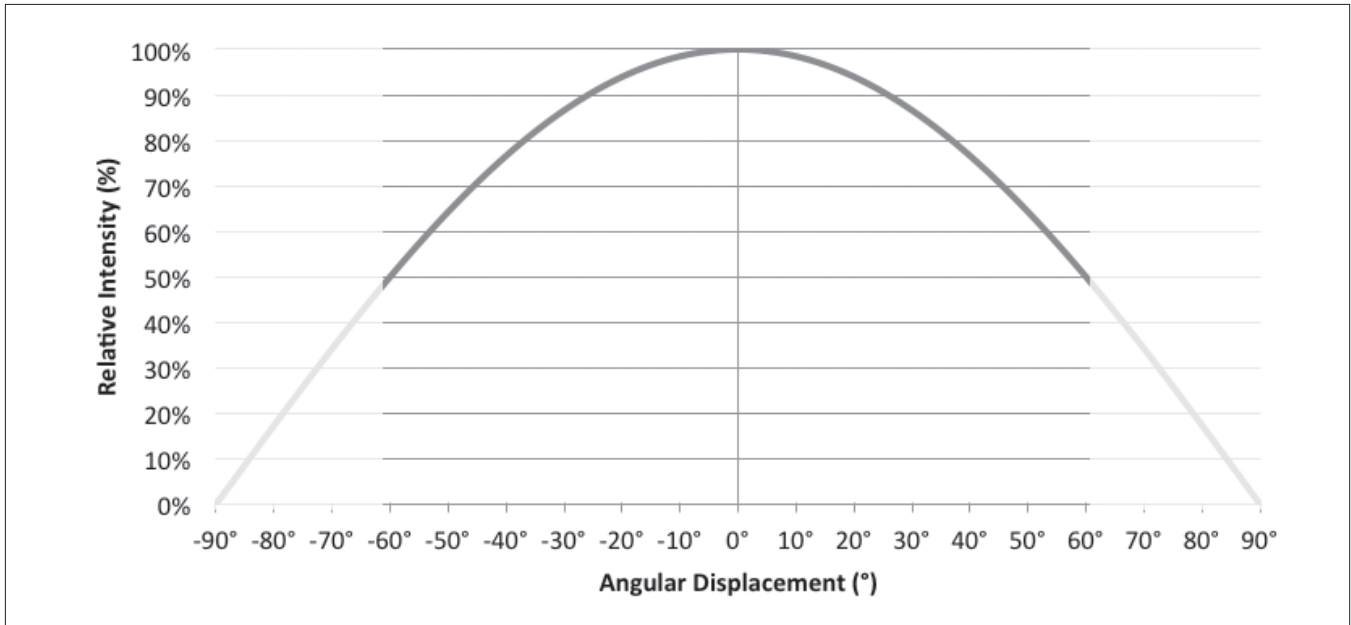

Notes for Figure 17:

1. Typical viewing angle is 120°.
2. The viewing angle is defined as the off axis angle from the centerline where intensity is ½ of the peak value.

Figure 18: Typical Polar Radiation Pattern

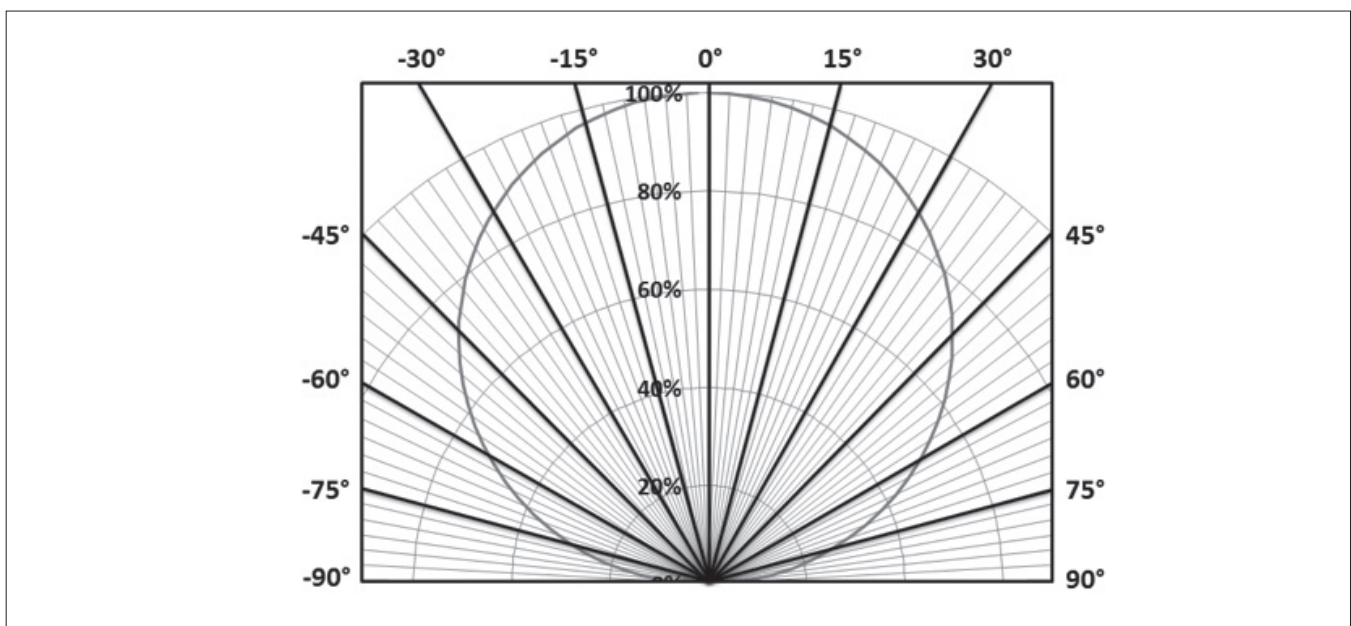

Typical Color Spectrum

Figure 19: Typical Color Spectrum

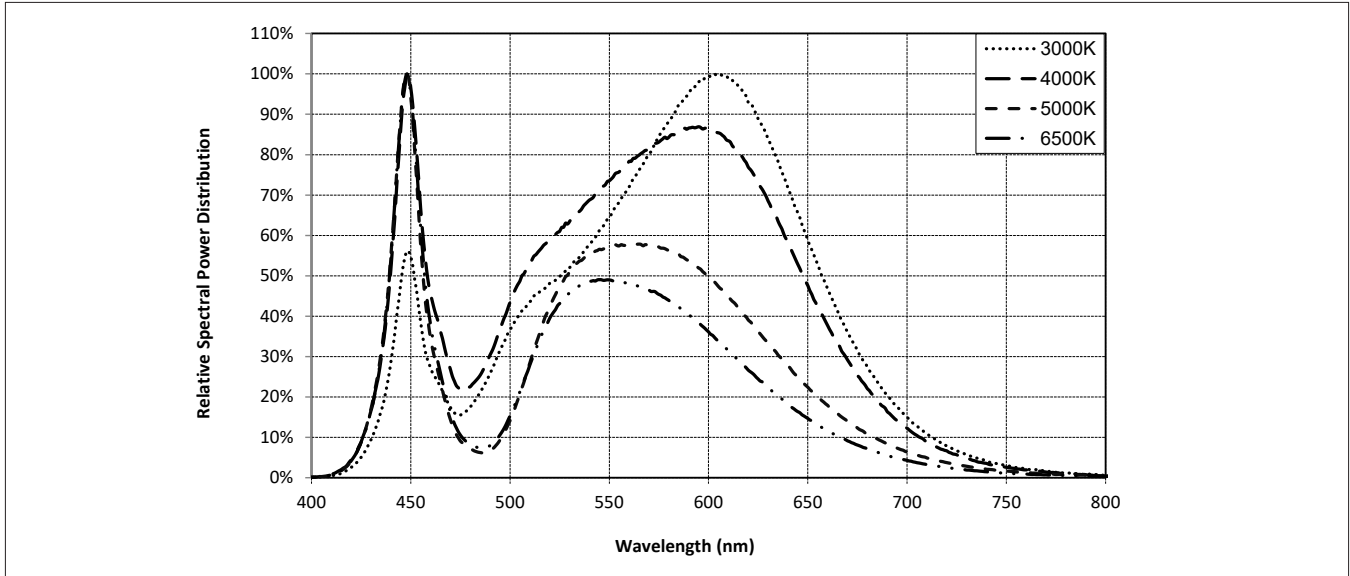

Notes for Figure 19:

1. Color spectra measured at nominal current for $T_j = T_c = 25^\circ\text{C}$.
2. Color spectra shown is 3000K and 80 CRI.
3. Color spectra shown is 4000K and 80 CRI.
4. Color spectra shown is 5000K and 70 CRI.
4. Color spectra shown is 6500K and 70 CRI.

Figure 20: Typical Color Spectrum for Vero 10 with Décor Series

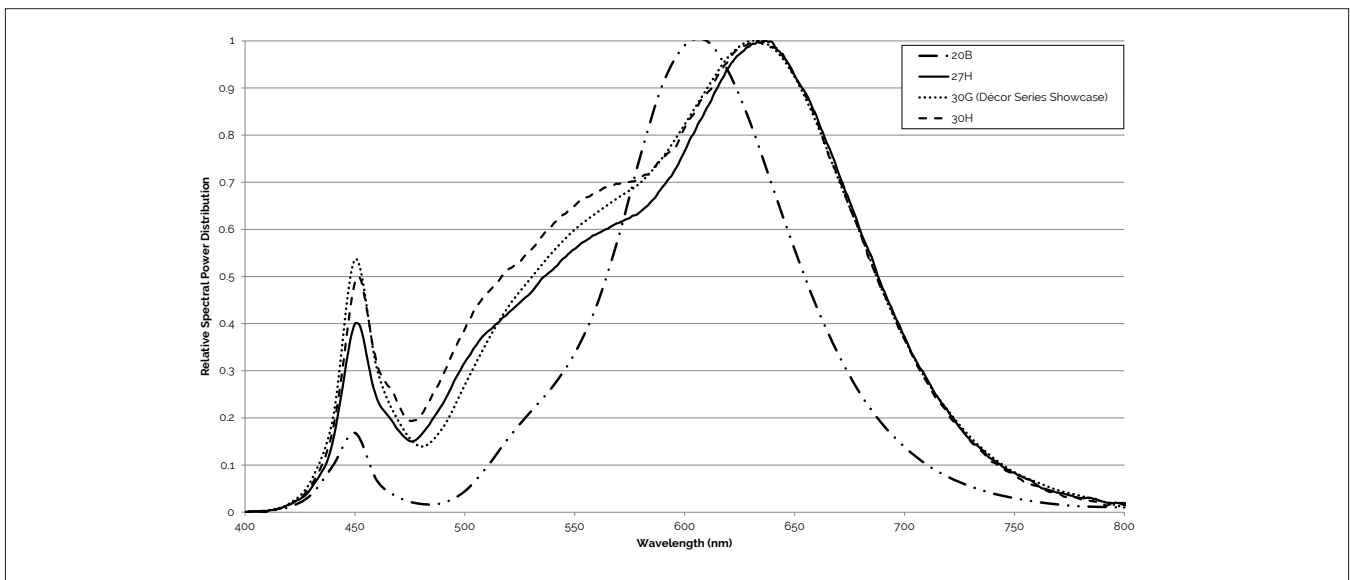

Note for Figure 20:

1. Color spectra measured at nominal current for $T_j = T_c = 25^\circ\text{C}$.

Color Binning Information

Figure 22: Warm and Neutral White Test Bins in xy Color Space

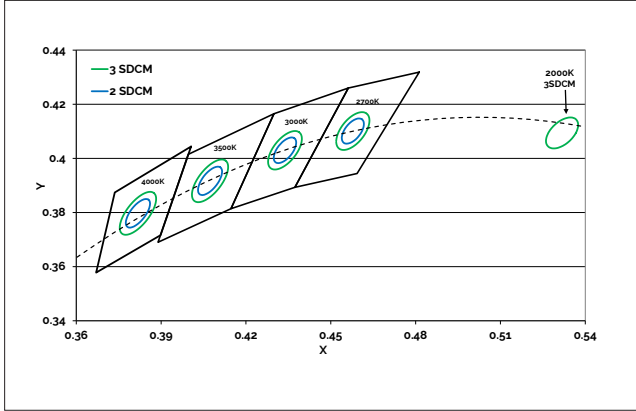

Note: Pulsed Test Conditions, $T_c = 25^\circ\text{C}$

Figure 23: Graph of Cool White Test Bins in xy Color Space

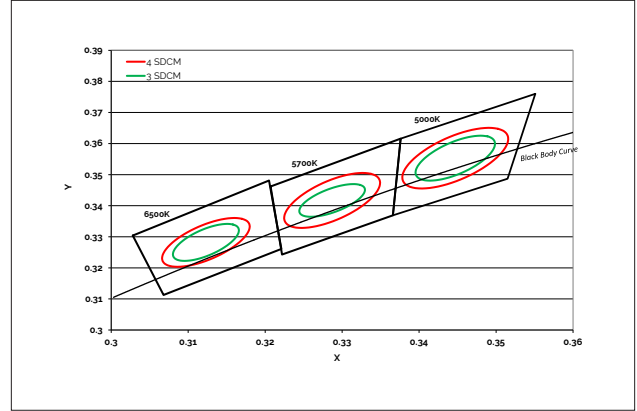

Note: Pulsed Test Conditions, $T_c = 25^\circ\text{C}$

Table 9: Warm and Neutral White xy Bin Coordinates and Associated Typical CCT

Bin Code	2000K	2700K	3000K ¹	3500K ¹	4000K ¹
ANSI Bin (for reference only)	-	(2580K - 2870K)	(2870K - 3220K)	(3220K - 3710K)	(3710K - 4260K)
73 (3 SDCM)	-	(2651K - 2794K)	(2968K - 3136K)	(3369K - 3586K)	(3851K - 4130K)
72 (2 SDCM)	-	(2674K - 2769K)	(2995K - 3107K)	(3404K - 3548K)	(3895K - 4081K)
Center Point (x,y)	(0.5280, 0.4100)	(0.4578, 0.4101)	(0.4338, 0.403) (0.4465, 0.4024) ²	(0.4073, 0.3917)	(0.3818, 0.3797)

Notes for Table 9:

1. Color Binning information excludes Decor Series Class A products. Please contact your Bridgelux Sales Representative for more information.
2. Center Point for Decor Series Showcase.
3. Bridgelux maintains a tolerance of +/- 0.007 on x and y color coordinates in the CIE 1931 color Space.

Table 10: Cool White xy Bin Coordinates and Associated Typical CCT (product is hot targeted to $T_c = 85^\circ\text{C}$)

Bin Code	5000K	5700K	6500K
ANSI Bin (for reference only)	(4745K - 5311K)	(5312K - 6022K)	(6022K - 7042K)
74 (4 SDCM)	(4801K - 5282K)	(5395K - 5970K)	(6200K - 6910K)
73 (3 SDCM)	(4835K - 5215K)	(5460K - 5891K)	(6279K - 6811K)
Center Point (x,y)	(0.3447, 0.3553)	(0.3287, 0.3417)	(0.3123, 0.3282)

Note for Tables 10:

1. Bridgelux maintains a tolerance of +/- 0.007 on x and y color coordinates in the CIE 1931 color Space.

Packaging and Labeling

Figure 24: Drawing for Vero 10 Packaging Tray

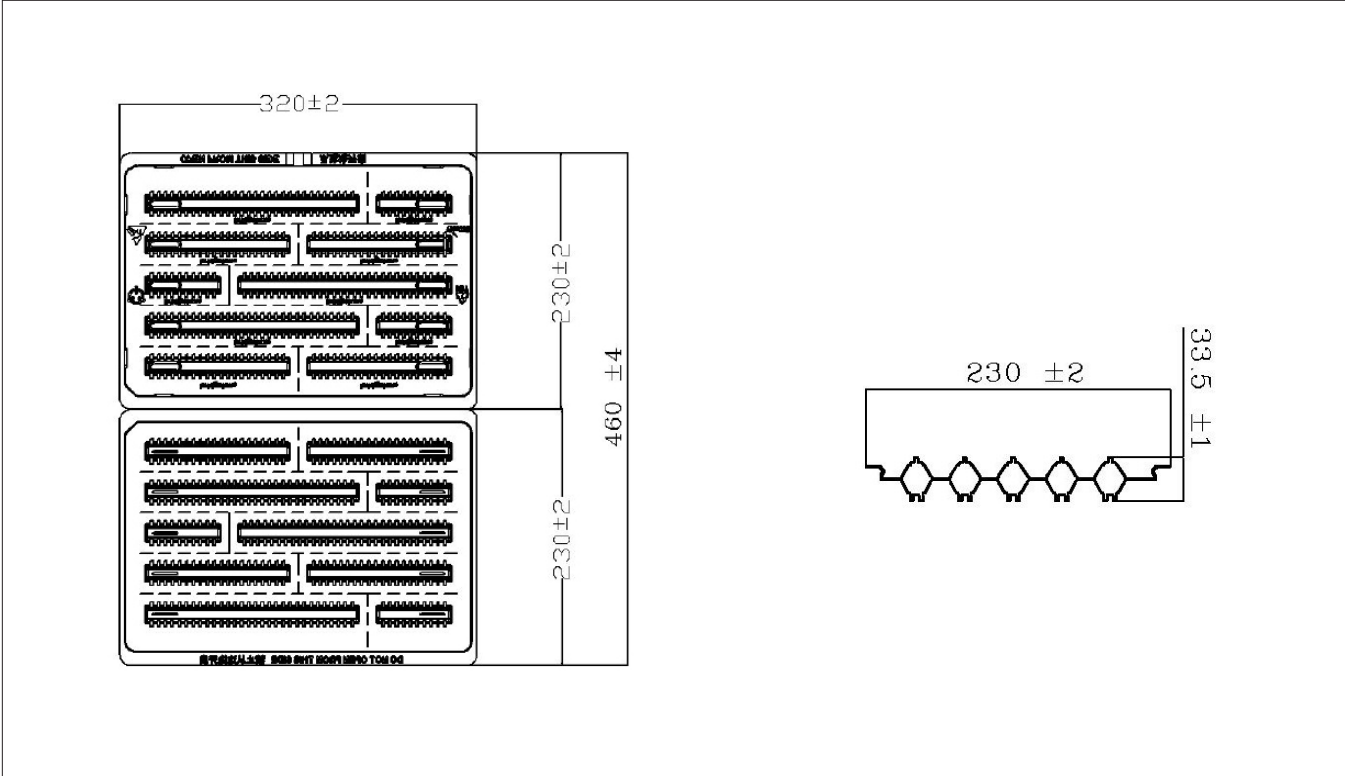

- Notes for Figure 24:
1. Dimensions are in millimeters.
 2. Drawings are not to scale.

Packaging and Labeling

Figure 25: Vero Series Packaging and Labeling

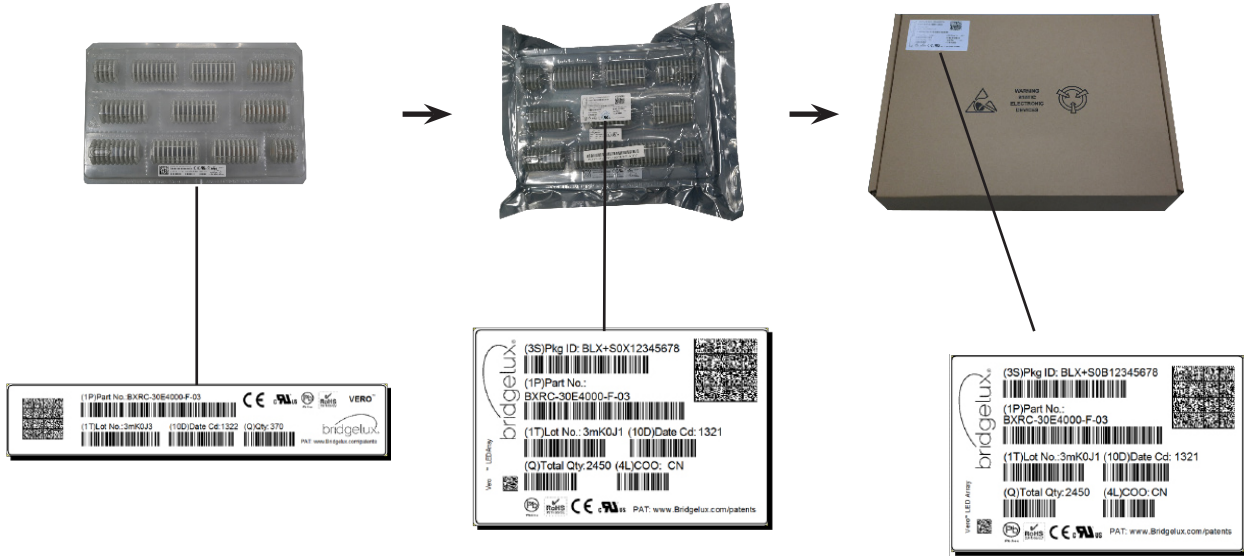

Notes for Figure 25:

1. Each tray holds 200 COBs.
2. Each tray is vacuum sealed in an anti-static bag and placed in its own box.
3. Each tray, bag and box is to be labeled as shown above.

Figure 26: Gen. 7 Product Labeling

Bridgelux COB arrays have laser markings on the back side of the substrate to help with product identification. In addition to the product identification markings, Bridgelux COB arrays also contain markings for internal Bridgelux manufacturing use only. The image below shows which markings are for customer use and which ones are for Bridgelux internal use only. The Bridgelux internal manufacturing markings are subject to change without notice, however these will not impact the form, function or performance of the COB array.



Customer Use- 2D Barcode
Scannable barcode provides product part number and other Bridgelux internal production information.

Customer Use- Product part number

30E1000C 73 2F

Customer Use- V_f Bin Code included to enable greater luminaire design flexibility. Refer to ANG2 for bin code definitions.

Design Resources

Application Notes

Bridgelux has developed a comprehensive set of application notes and design resources to assist customers in successfully designing with the Vero product family of LED array products. For all available application notes visit www.bridgelux.com.

Optical Source Models

Optical source models and ray set files are available for all Bridgelux products. For a list of available formats, visit www.bridgelux.com.

3D CAD Models

Three dimensional CAD models depicting the product outline of all Bridgelux Vero LED arrays are available in both IGS and STEP formats. Please contact your Bridgelux sales representative for assistance.

LM80

LM80 testing has been completed and the LM80 report is now available. Please contact your Bridgelux sales representative for LM-80 report.

Precautions

CAUTION: CHEMICAL EXPOSURE HAZARD

Exposure to some chemicals commonly used in luminaire manufacturing and assembly can cause damage to the LED array. Please consult Bridgelux Application Note AN31 for additional information.

CAUTION: RISK OF BURN

Do not touch the Vero LED array during operation. Allow the array to cool for a sufficient period of time before handling. The Vero LED array may reach elevated temperatures such that could burn skin when touched.

CAUTION

CONTACT WITH LIGHT EMITTING SURFACE (LES)

Avoid any contact with the LES. Do not touch the LES of the LED array or apply stress to the LES (yellow phosphor resin area). Contact may cause damage to the LED array.

Optics and reflectors must not be mounted in contact with the LES (yellow phosphor resin area). Optical devices may be mounted on the top surface of the plastic housing of the Vero LED array. Use the mechanical features of the LED array housing, edges and/or mounting holes to locate and secure optical devices as needed.

Disclaimers

MINOR PRODUCT CHANGE POLICY

The rigorous qualification testing on products offered by Bridgelux provides performance assurance. Slight cosmetic changes that do not affect form, fit, or function may occur as Bridgelux continues product optimization.

STANDARD TEST CONDITIONS

Unless otherwise stated, array testing is performed at the nominal drive current.

About Bridgelux: Bridging Light and Life™

At Bridgelux, we help companies, industries and people experience the power and possibility of light. Since 2002, we've designed LED solutions that are high performing, energy efficient, cost effective and easy to integrate. Our focus is on light's impact on human behavior, delivering products that create better environments, experiences and returns—both experiential and financial. And our patented technology drives new platforms for commercial and industrial luminaires.

For more information about the company, please visit
bridgelux.com
twitter.com/Bridgelux
facebook.com/Bridgelux
youtube.com/user/Bridgelux
linkedin.com/company/bridgelux-inc-_2
WeChat ID: BridgeluxInChina



46410 Fremont Boulevard
Fremont, CA 94538 U.S.A.
Tel (925) 583-8400
www.bridgelux.com