

Bridgelux® Gen 8 V11 HD LED Array

Product Data Sheet DS409



Introduction

V Series HD

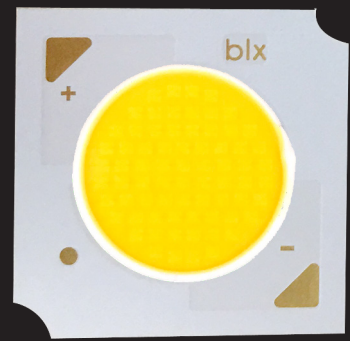

V Series™ HD LED array product, an ultra-high lumen density COB product line, is designed for high intensity spotlights used in commercial and retail settings. V Series HD arrays offer industry leading color over angle uniformity, and replace ceramic metal halide lamps by providing equal or greater center beam candle power at lower power and at greater lifetimes. Their tight beam control and exceptional quality of light is well suited for demanding directional spot applications.

The Vg HD LED array is available in a variety of CCT and CRI combinations providing substantial design flexibility and energy efficiencies.

Lighting system designs incorporating these LED arrays deliver increased system level efficacy and longer service life. Typical applications include, but are not limited to, commercial and residential down lights, accent, spot and track lights.

Bridgelux Décor Series™ is our state of the art color line designed specifically for premium applications, producing unmatched LED light quality with brilliant color-rendering options and offer pleasing and inspiring lighting palettes. Bridgelux Décor Series color points are available on Vero® SE Series, Vero® Series, V Series™ and V Series™ HD.

Décor Series™ Ultra products provide a high CRI of 97 and a minimum Rg value of 91, which emphasizes the reds and color tones to which the human eye is most receptive - perfect for the most luxurious retail shops and world renowned museums. Décor Series Ultra is designed as a replacement for halogen.

Features

- Efficacy of 141 lm/W typical
- Compact high flux density light source
- Uniform high quality illumination
- Minimum 80, 90 and 95 CRI options
- Streamlined thermal path
- ENERGY STAR® / ANSI compliant color binning structure with 3 SDCM options
- More energy efficient than incandescent, halogen and fluorescent lamps
- Low voltage DC operation
- Instant light with unlimited dimming
- V_f bin code backside marking

Benefits

- Enhanced optical control
- Clean white light without pixelation
- High quality true color reproduction
- Significantly reduced thermal resistance and increased operating temperatures
- Uniform consistent white light
- Lower operating costs
- Easy to use with daylight and motion detectors to enable increased energy savings
- Reduced maintenance costs
- Environmentally friendly, no disposal issue



Contents

Product Feature Map	2
Product Nomenclature	2
Product Selection Guide	3
Performance at Commonly Used Drive Currents	5
Electrical Characteristics	7
Eye Safety	8
Absolute Maximum Ratings	9
Performance Curves	10
Typical Radiation Pattern	11
Typical Color Spectrum	12
Mechanical Dimensions	13
Color Binning Information	14
Packaging and Labeling	15
Design Resources	17
Precautions	17
Disclaimers	17
About Bridgelux	18

Product Feature Map

Bridgelux arrays are fully engineered devices that provide consistent thermal and optical performance on an engineered mechanical platform. The V Series HD arrays are the most compact chip-on-board devices across all of Bridgelux's LED Array products.

The arrays incorporate several features to simplify design integration and assembly. Please visit www.bridgelux.com for more information on the V Series HD family of products.

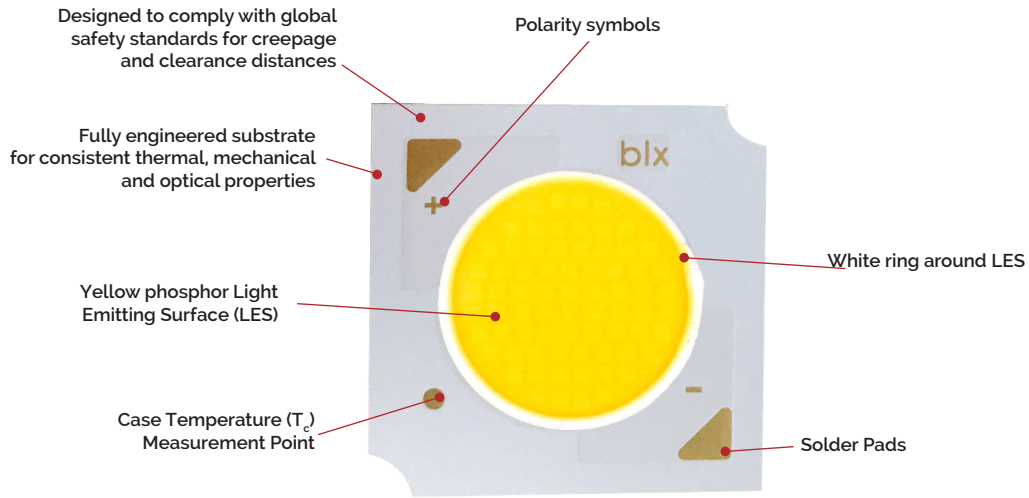

Note: Part number and lot codes are scribed on back of array

Product Nomenclature

The part number designation for Bridgelux V Series HD LED arrays is explained as follows:

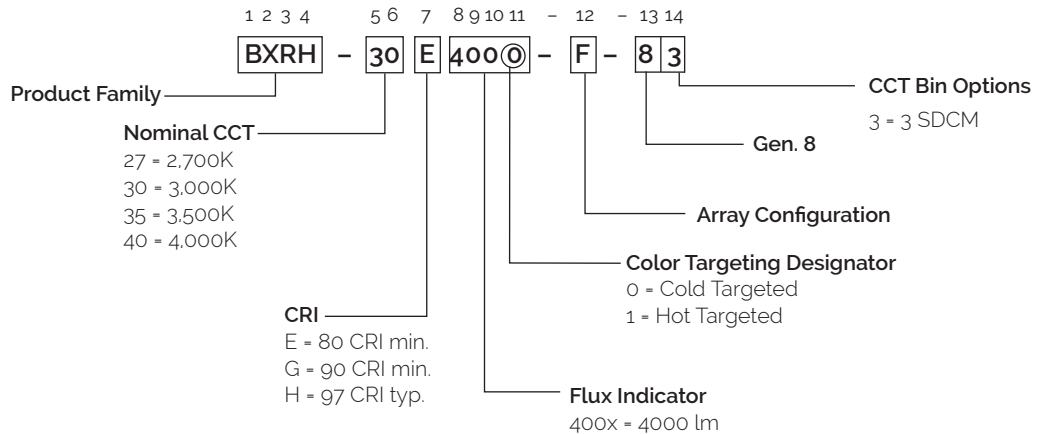

Product Selection Guide

The following product configurations are available:

Table 1: Selection Guide, Pulsed Measurement Data ($T_j = T_c = 25^\circ\text{C}$)

Part Number	Nominal CCT ¹ (K)	CRI ²	Nominal Drive Current ³ (mA)	Typical Pulsed Flux ^{4,5,6} $T_c = 25^\circ\text{C}$ (lm)	Minimum Pulsed Flux ^{6,7} $T_c = 25^\circ\text{C}$ (lm)	Typical V_f (V)	Typical Power (W)	Typical Efficacy (lm/W)
BXRH-27E4000-F-83	2700	80	1050	5092	4583	36.6	38.4	132
BXRH-27G4000-F-83	2700	90	1050	4360	3924	36.6	38.4	113
BXRH-27H4000-F-83	2700	97	1050	3723	3351	36.6	38.4	97
BXRH-30E4000-F-83	3000	80	1050	5410	4869	36.6	38.4	141
BXRH-30G4000-F-83	3000	90	1050	4583	4124	36.6	38.4	119
BXRH-30H4000-F-83	3000	97	1050	3978	3580	36.6	38.4	104
BXRH-35E4000-F-83	3500	80	1050	5537	4984	36.6	38.4	144
BXRH-35G4000-F-83	3500	90	1050	4778	4300	36.6	38.4	124
BXRH-35H4000-F-83	3500	97	1050	4089	3680	36.6	38.4	106
BXRH-40E4000-F-83	4000	80	1050	5569	5012	36.6	38.4	145
BXRH-40G4000-F-83	4000	90	1050	4833	4349	36.6	38.4	126
BXRH-40H4000-F-83	4000	97	1050	4201	3781	36.6	38.4	109
BXRH-50E4001-F-84	5000	80	1050	5633	5069	36.6	38.4	147
BXRH-50G4001-F-84	5000	90	1050	4868	4381	36.6	38.4	127

Notes for Table 1:

- Nominal CCT as defined by ANSI C78.377-2011.
- CRI values are typical for Decor Series Ultra and Decor Series Class A products. CRI values are minimums for all other products. Minimum Rg value for 80 CRI products is 0, the minimum Rg values for 90 CRI products is 50, the minimum Rg values for 97 CRI products is 91. Bridgelux maintains a ± 3 tolerance on CRI and Rg values.
- Drive current is referred to as nominal drive current.
- Products tested under pulsed condition (10ms pulse width) at nominal test current where T_j (junction temperature) = T_c (case temperature) = 25°C .
- Typical performance values are provided as a reference only and are not a guarantee of performance.
- Bridgelux maintains a $\pm 7\%$ tolerance on flux measurements.
- Minimum flux values at the nominal test current are guaranteed by 100% test.

Product Selection Guide

Table 2: Selection Guide, Stabilized DC Performance ($T_c = 85^\circ\text{C}$)

Part Number	Nominal CCT ¹ (K)	CRI ²	Nominal Drive Current ³ (mA)	Typical DC Flux ^{4,5} $T_c = 85^\circ\text{C}$ (lm)	Minimum DC Flux ⁶ $T_c = 85^\circ\text{C}$ (lm)	Typical V_f (V)	Typical Power (W)	Typical Efficacy (lm/W)
BXRH-27E4000-F-83	2700	80	1050	4583	4124	35.4	37.2	123
BXRH-27G4000-F-83	2700	90	1050	3924	3531	35.4	37.2	106
BXRH-27H4000-F-83	2700	97	1050	3351	3016	35.4	37.2	90
BXRH-30E4000-F-83	3000	80	1050	4869	4382	35.4	37.2	131
BXRH-30G4000-F-83	3000	90	1050	4124	3712	35.4	37.2	111
BXRH-30H4000-F-83	3000	97	1050	3580	3222	35.4	37.2	96
BXRH-35E4000-F-83	3500	80	1050	4984	4485	35.4	37.2	134
BXRH-35G4000-F-83	3500	90	1050	4300	3870	35.4	37.2	116
BXRH-35H4000-F-83	3500	97	1050	3680	3312	35.4	37.2	99
BXRH-40E4000-F-83	4000	80	1050	5012	4511	35.4	37.2	135
BXRH-40G4000-F-83	4000	90	1050	4349	3915	35.4	37.2	117
BXRH-40H4000-F-83	4000	97	1050	3781	3403	35.4	37.2	102
BXRH-50E4001-F-84	5000	80	1050	5069	4562	35.4	37.2	136
BXRH-50G4001-F-84	5000	90	1050	4381	3943	35.4	37.2	118

Notes for Table 2:

- Nominal CCT as defined by ANSI C78.377-2011.
- All CRI values are measured at $T_j = T_c = 25^\circ\text{C}$. CRI values are typical for Decor Series Ultra and Decor Series Class A products. CRI values are minimums for all other products. Minimum Rg value for 80 CRI products is 0, the minimum Rg values for 90 CRI products is 50, the minimum Rg values for 97 CRI products is 91. Bridgelux maintains a ± 3 tolerance on CRI and Rg values.
- Drive current is referred to as nominal drive current.
- Typical stabilized DC performance values are provided as reference only and are not a guarantee of performance.
- Typical performance is estimated based on operation under DC (direct current) with LED array mounted onto a heat sink with thermal interface material and the case temperature maintained at 85°C . Based on Bridgelux test setup, values may vary depending on the thermal design of the luminaire and/or the exposed environment to which the product is subjected.
- Minimum flux values at elevated temperatures are provided for reference only and are not guaranteed by 100% production testing. Based on Bridgelux test setup, values may vary depending on the thermal design of the luminaire and/or the exposed environment to which the product is subjected.

Performance at Commonly Used Drive Currents

V Series HD LED arrays are tested to the specifications shown using the nominal drive currents in Table 1. V Series HD LED arrays may also be driven at other drive currents dependent on specific application design requirements. The performance at any drive current can be derived from the current vs. voltage characteristics shown in Figure 1 and the flux vs. current characteristics shown in Figure 2. The performance at commonly used drive currents is summarized in Table 3.

Table 3: Product Performance at Commonly Used Drive Currents

Part Number	CRI	Drive Current ¹ (mA)	Typical V_f $T_c = 25^\circ\text{C}$ (V)	Typical Power $T_c = 25^\circ\text{C}$ (W)	Typical Flux ² $T_c = 25^\circ\text{C}$ (lm)	Typical DC Flux ³ $T_c = 85^\circ\text{C}$ (lm)	Typical Efficacy $T_c = 25^\circ\text{C}$ (lm/W)
BXRH-27E4000-F-83	80	525	34.2	18.0	2703	2432	150
		750	35.3	26.5	3763	3387	142
		1050	36.6	38.4	5092	4583	132
		1313	37.7	49.5	6184	5565	125
		1440	38.2	55.1	6687	6018	121
		1800	39.5	71.1	8016	7215	113
BXRH-27G4000-F-83	90	525	34.2	18.0	2314	2083	129
		750	35.3	26.5	3222	2900	122
		1050	36.6	38.4	4360	3924	113
		1313	37.7	49.5	5295	4765	107
		1440	38.2	55.1	5726	5153	104
		1800	39.5	71.1	6864	6178	97
BXRH-27H4000-F-83	97	525	34.2	18.0	1976	1779	110
		750	35.3	26.5	2752	2476	104
		1050	36.6	38.4	3723	3351	97
		1313	37.7	49.5	4522	4070	91
		1440	38.2	55.1	4890	4401	89
		1800	39.5	71.1	5862	5276	82
BXRH-30E4000-F-83	80	525	34.2	18.0	2872	2584	160
		750	35.3	26.5	3998	3598	151
		1050	36.6	38.4	5410	4869	141
		1313	37.7	49.5	6570	5913	133
		1440	38.2	55.1	7105	6394	129
		1800	39.5	71.1	8517	7666	120
BXRH-30G4000-F-83	90	525	34.2	18.0	2432	2189	135
		750	35.3	26.5	3387	3048	128
		1050	36.6	38.4	4583	4124	119
		1313	37.7	49.5	5565	5009	112
		1440	38.2	55.1	6018	5416	109
		1800	39.5	71.1	7215	6493	102
BXRH-30H4000-F-83	97	525	34.2	18.0	2111	1900	118
		750	35.3	26.5	2940	2646	111
		1050	36.6	38.4	3978	3580	104
		1313	37.7	49.5	4831	4348	98
		1440	38.2	55.1	5224	4702	95
		1800	39.5	71.1	6263	5637	88

Notes for Table 3:

1. Alternate drive currents are provided for reference only and are not a guarantee of performance.
2. Bridgelux maintains a $\pm 7\%$ tolerance on flux measurements.
3. Typical stabilized DC performance values are provided as reference only and are not a guarantee of performance.

Performance at Commonly Used Drive Currents

Table 3: Product Performance at Commonly Used Drive Currents (continued)

Part Number	CRI	Drive Current ¹ (mA)	Typical V_f $T_c = 25^\circ\text{C}$ (V)	Typical Power $T_c = 25^\circ\text{C}$ (W)	Typical Flux ² $T_c = 25^\circ\text{C}$ (lm)	Typical DC Flux ³ $T_c = 85^\circ\text{C}$ (lm)	Typical Efficacy $T_c = 25^\circ\text{C}$ (lm/W)
BXRH-35E4000-F-83	80	525	34.2	18.0	2939	2645	164
		750	35.3	26.5	4092	3683	155
		1050	36.6	38.4	5537	4984	144
		1313	37.7	49.5	6725	6052	136
		1440	38.2	55.1	7272	6545	132
		1800	39.5	71.1	8718	7846	123
BXRH-35G4000-F-83	90	525	34.2	18.0	2536	2283	141
		750	35.3	26.5	3531	3178	133
		1050	36.6	38.4	4778	4300	124
		1313	37.7	49.5	5803	5223	117
		1440	38.2	55.1	6275	5648	114
		1800	39.5	71.1	7523	6771	106
BXRH-35H4000-F-83	97	525	34.2	18.0	2171	1954	121
		750	35.3	26.5	3022	2720	114
		1050	36.6	38.4	4089	3680	106
		1313	37.7	49.5	4966	4470	100
		1440	38.2	55.1	5370	4833	98
		1800	39.5	71.1	6438	5794	91
BXRH-40E4000-F-83	80	525	34.2	18.0	2956	2660	165
		750	35.3	26.5	4116	3704	155
		1050	36.6	38.4	5569	5012	145
		1313	37.7	49.5	6763	6087	137
		1440	38.2	55.1	7314	6582	133
		1800	39.5	71.1	8768	7891	123
BXRH-40G4000-F-83	90	525	34.2	18.0	2565	2309	143
		750	35.3	26.5	3571	3214	135
		1050	36.6	38.4	4833	4349	126
		1313	37.7	49.5	5869	5282	118
		1440	38.2	55.1	6347	5712	115
		1800	39.5	71.1	7609	6848	107
BXRH-40H4000-F-83	97	525	34.2	18.0	2230	2007	124
		750	35.3	26.5	3104	2794	117
		1050	36.6	38.4	4201	3781	109
		1313	37.7	49.5	5102	4591	103
		1440	38.2	55.1	5517	4965	100
		1800	39.5	71.1	6614	5952	93

Notes for Table 3:

1. Alternate drive currents in Table 3 are provided for reference only and are not a guarantee of performance.
2. Bridgelux maintains a $\pm 7\%$ tolerance on flux measurements.
3. Typical stabilized DC performance values are provided as reference only and are not a guarantee of performance.

Performance at Commonly Used Drive Currents

Table 3: Product Performance at Commonly Used Drive Currents (continued)

Part Number	CRI	Drive Current ¹ (mA)	Typical V_f $T_c = 25^\circ\text{C}$ (V)	Typical Power $T_c = 25^\circ\text{C}$ (W)	Typical Flux ² $T_c = 25^\circ\text{C}$ (lm)	Typical DC Flux ³ $T_c = 85^\circ\text{C}$ (lm)	Typical Efficacy $T_c = 25^\circ\text{C}$ (lm/W)
BXRH-50E4001-F-84	80	525	34.2	18.0	2990	2690	167
		750	35.3	26.5	4162	3746	157
		1050	36.6	38.4	5633	5069	147
		1313	37.7	49.5	6840	6156	138
		1440	38.2	55.1	7397	6657	134
		1800	39.5	71.1	8867	7981	125
BXRH-50G4001-F-84	90	525	34.2	18.0	2584	2325	144
		750	35.3	26.5	3597	3238	136
		1050	36.6	38.4	4868	4381	127
		1313	37.7	49.5	5912	5321	119
		1440	38.2	55.1	6393	5753	116
		1800	39.5	71.1	7664	6898	108

Notes for Table 3:

1. Alternate drive currents in Table 3 are provided for reference only and are not a guarantee of performance.
2. Bridgelux maintains a $\pm 7\%$ tolerance on flux measurements.
3. Typical stabilized DC performance values are provided as reference only and are not a guarantee of performance.

Electrical Characteristics

Table 4: Electrical Characteristics

Part Number	Drive Current (mA)	Forward Voltage Pulsed, $T_c = 25^\circ\text{C}$ (V) ^{1, 2, 3, 8}			Typical Coefficient of Forward Voltage ⁴ $\Delta V_f / \Delta T_c$ (mV/ $^\circ\text{C}$)	Typical Thermal Resistance Junction to Case ^{5,6} R_{j-c} ($^\circ\text{C}/\text{W}$)	Driver Selection Voltages ⁷ (V)	
		Minimum	Typical	Maximum			V_f Min. Hot $T_c = 105^\circ\text{C}$ (V)	V_f Max. Cold $T_c = -40^\circ\text{C}$ (V)
BXRH-xxx40xx-F-83	1050	33.9	36.6	39.3	-20.00	0.093	32.3	40.6
	1800	36.5	39.5	42.5	-21.58	0.253	34.8	43.9

Notes for Table 4:

- Parts are tested in pulsed conditions. $T_c = 25^\circ\text{C}$. Pulse width is 10ms.
- Voltage minimum and maximum are provided for reference only and are not a guarantee of performance.
- Bridgelux maintains a tester tolerance of $\pm 0.10\text{V}$ on forward voltage measurements.
- Typical coefficient of forward voltage tolerance is $\pm 0.1\text{mV}$ for nominal current.
- Thermal resistance values are based from test data of a 3000K 80 CRI product.
- Thermal resistance value was calculated using total electrical input power; optical power was not subtracted from input power. The thermal interface material used during testing is not included in the thermal resistance value.
- V_f min hot and max cold values are provided as reference only and are not guaranteed by test. These values are provided to aid in driver design and selection over the operating range of the product.
- This product has been designed and manufactured per IEC 62031:2018. This product has passed dielectric withstand voltage testing at 500 V. The working voltage designated for the insulation is 50V d.c. The maximum allowable voltage across the array must be determined in the end product application.

Eye Safety

Table 5: Eye Safety Risk Group (RG) Classifications

Part Number	Drive Current (mA)	CCT ^{1,4}	
		2700K/3000K ²	4000K ³
BXRH-xxx40xx-F-83	1050	RG1	RG2
	1400	RG1	RG2

Notes for Table 5:

1. Eye safety classification for the use of Bridgelux V Series, HD LED arrays is in accordance with specification IEC/TR 62778: Application of IEC 62471 for the assessment of blue light hazard to light sources and luminaires.
2. For products classified as RG2 at 3000K, $E_{thr} = 2670$ lx.
3. For products classified as RG2 at 4000K, $E_{thr} = 1760$ lx.
4. Please contact your Bridgelux sales representative for E_{thr} values at specific drive currents and CCTs not listed.

Absolute Maximum Ratings

Table 6: Maximum Ratings

Parameter	Maximum Rating
LED Junction Temperature (T_j)	125°C
Storage Temperature	-40°C to +105°C
Operating Case Temperature ¹ (T_c)	105°C
Soldering Temperature ²	300°C or lower for a maximum of 6 seconds
	BXRH-xxx40xx-F-83
Maximum Drive Current ³	1800 mA
Maximum Peak Pulsed Drive Current ⁴	2036 mA
Maximum Reverse Voltage ⁵	-60V

Notes for Table 6:

1. For IEC 62717 requirement, please consult your Bridgelux sales representative.
2. Refer to Bridgelux Application Note AN101: Handling and Assembly of Bridgelux V Series LED Arrays.
3. Arrays may be driven at higher currents however lumen maintenance may be reduced and warranty will not apply.
4. Bridgelux recommends a maximum duty cycle of 10% and pulse width of 20 ms when operating LED Arrays at maximum peak pulsed current specified. Maximum peak pulsed currents indicate values where LED Arrays can be driven without catastrophic failures.
5. Light emitting diodes are not designed to be driven in reverse voltage and will not produce light under this condition. Maximum rating provided for reference only.

Performance Curves

Figure 1: V11 HD Drive Current vs. Voltage ($T_j = T_c = 25^\circ\text{C}$)¹

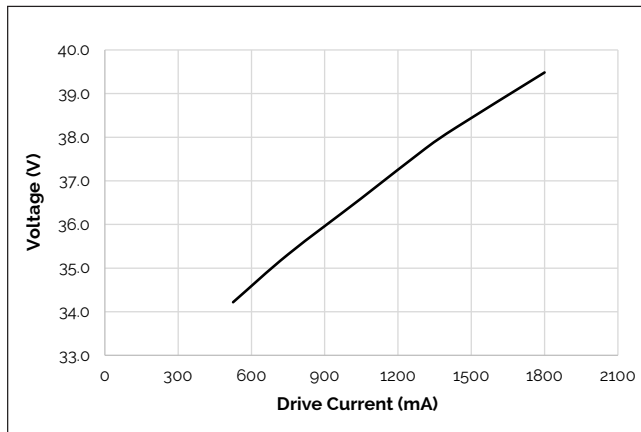

Figure 2: V11 HD Typical Relative Luminous Flux vs. Drive Current ($T_j = T_c = 25^\circ\text{C}$)¹

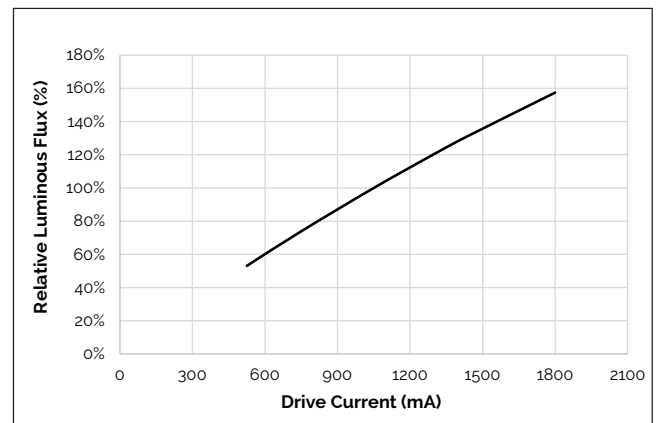

Figure 3: Typical DC Flux vs. Case Temperature

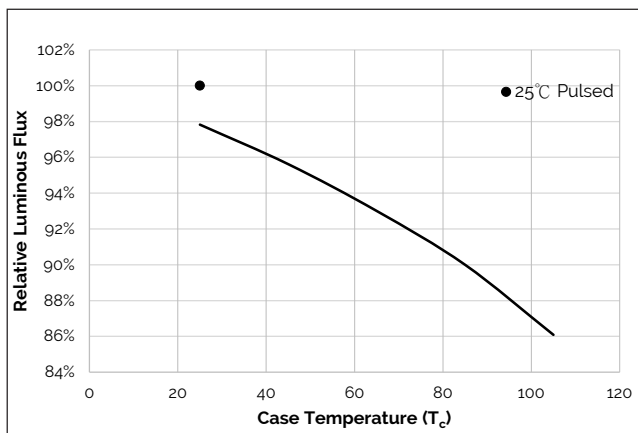

Figure 4: Typical DC cxx Shift vs. Case Temperature

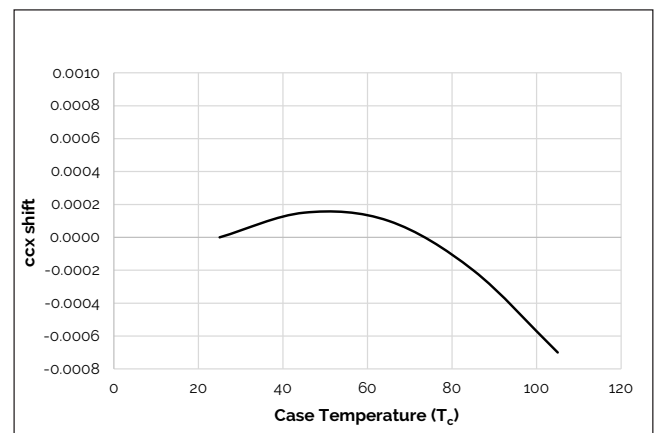

Figure 5: Typical DC ccy Shift vs. Case Temperature

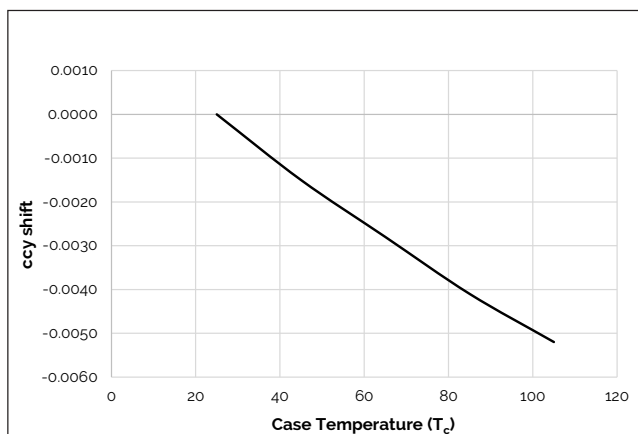
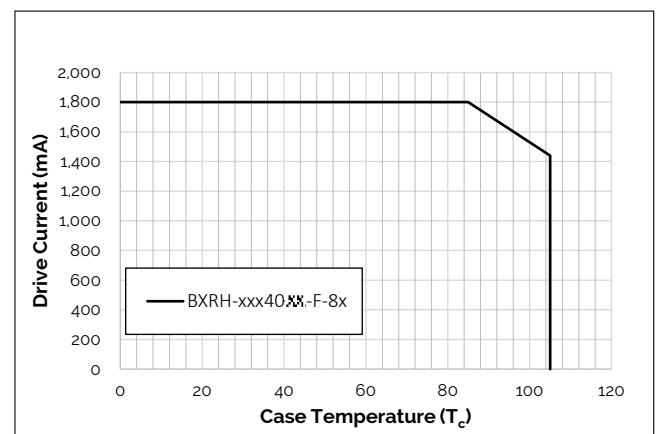

Figure 6: Derating Curve



Notes for Figures 1 - 4:

1. Bridgelux does not recommend driving high power LEDs at low currents. Doing so may produce unpredictable results. Pulse width modulation (PWM) is recommended for dimming effects.
2. Characteristics shown for 3000K and 90 CRI.

Typical Radiation Pattern

Figure 7: Typical Spatial Radiation Pattern

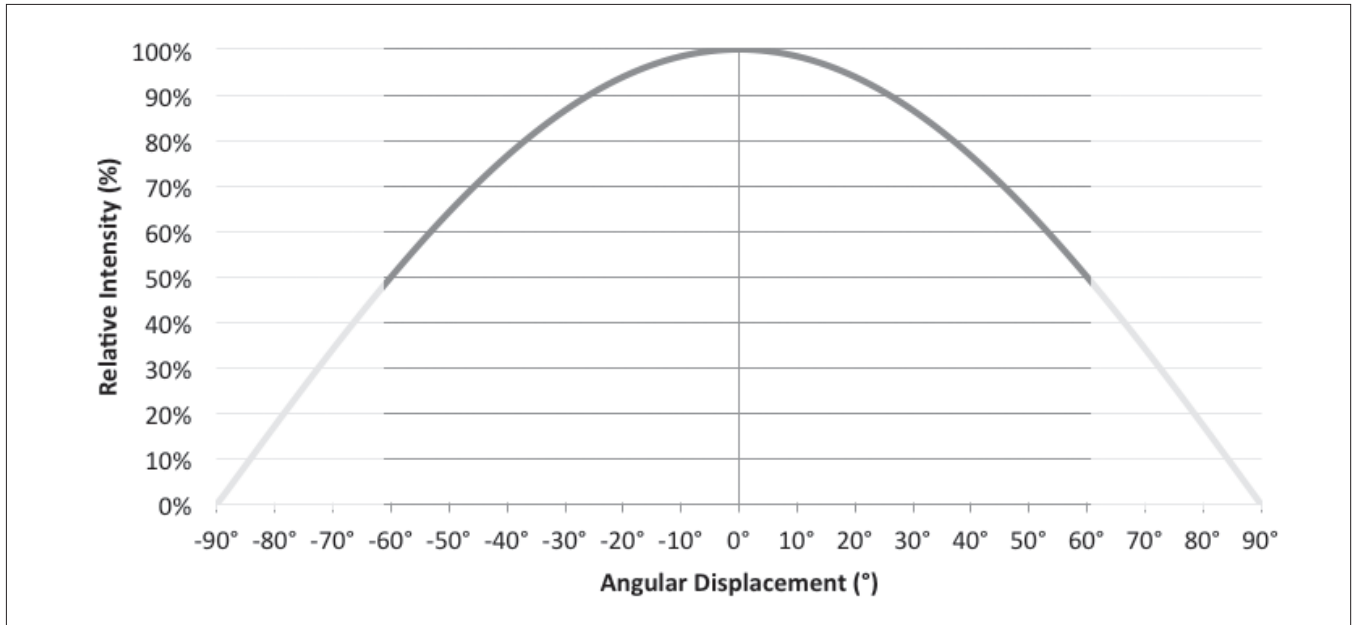

Notes for Figure 7:

1. Typical viewing angle is 120°.
2. The viewing angle is defined as the off axis angle from the centerline where intensity is ½ of the peak value.

Figure 8: Typical Polar Radiation Pattern

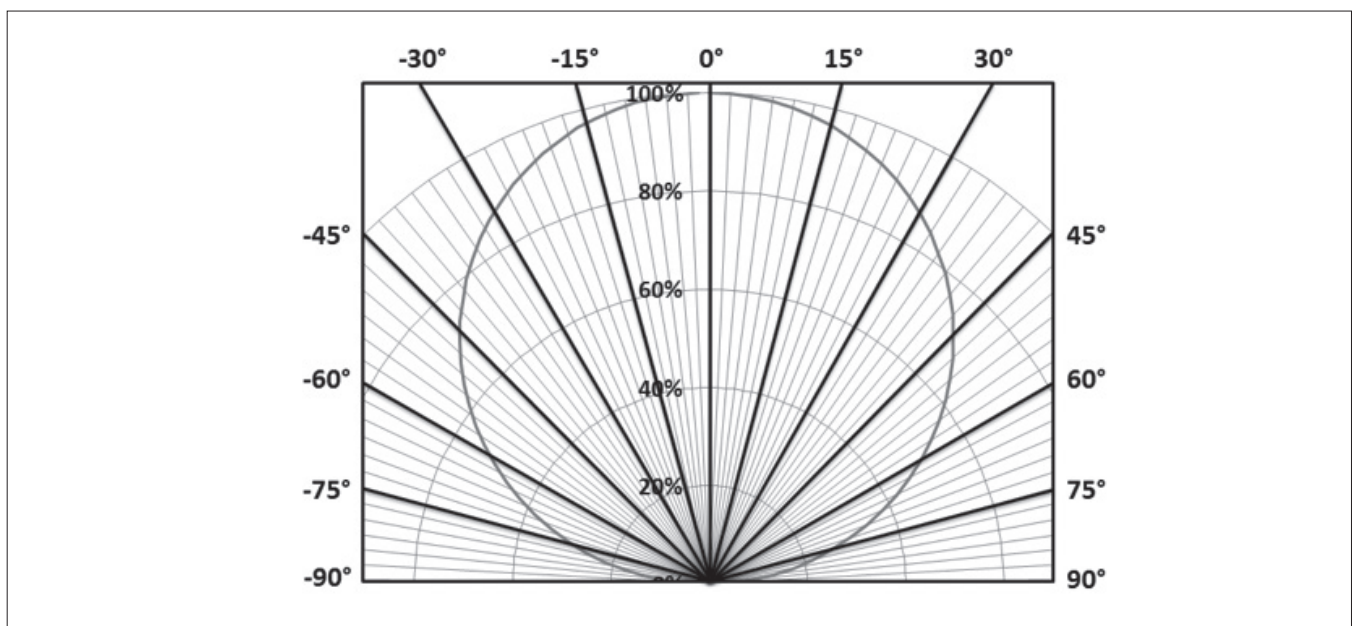

Typical Color Spectrum

Figure 9: Typical Color Spectrum

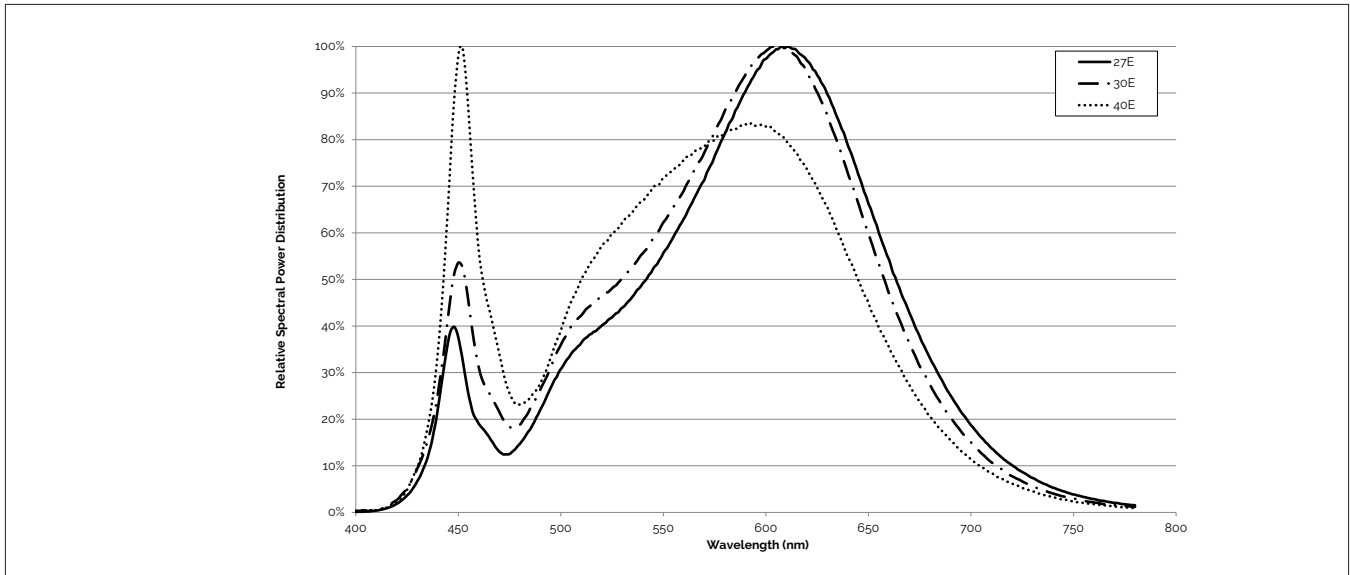

Notes for Figure 9:

1. Color spectra measured at nominal current for $T_j = T_c = 25^\circ\text{C}$.
2. Color spectra shown is 2700K and 80 CRI.
3. Color spectra shown is 3000K and 80 CRI.
4. Color spectra shown is 4000K and 80 CRI.

Figure 10: Typical Color Spectrum for Décor Series

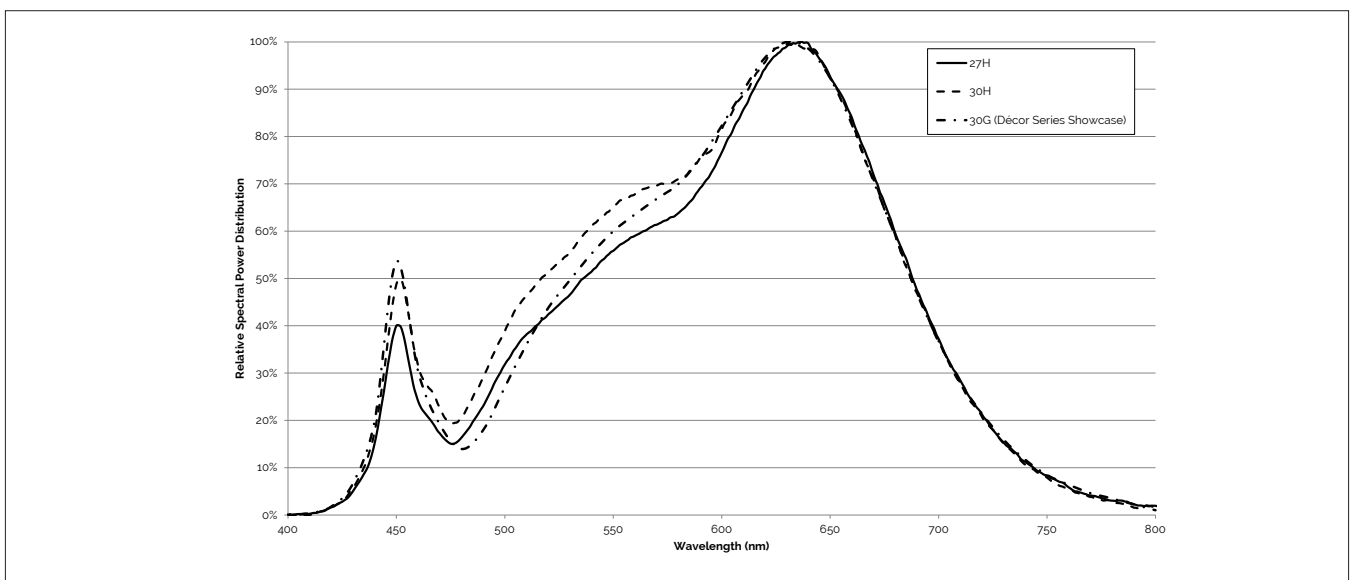

Note for Figure 10:

1. Color spectra measured at nominal current for $T_j = T_c = 25^\circ\text{C}$.

Mechanical Dimensions

Figure 11: Drawing for V11 HD LED Array

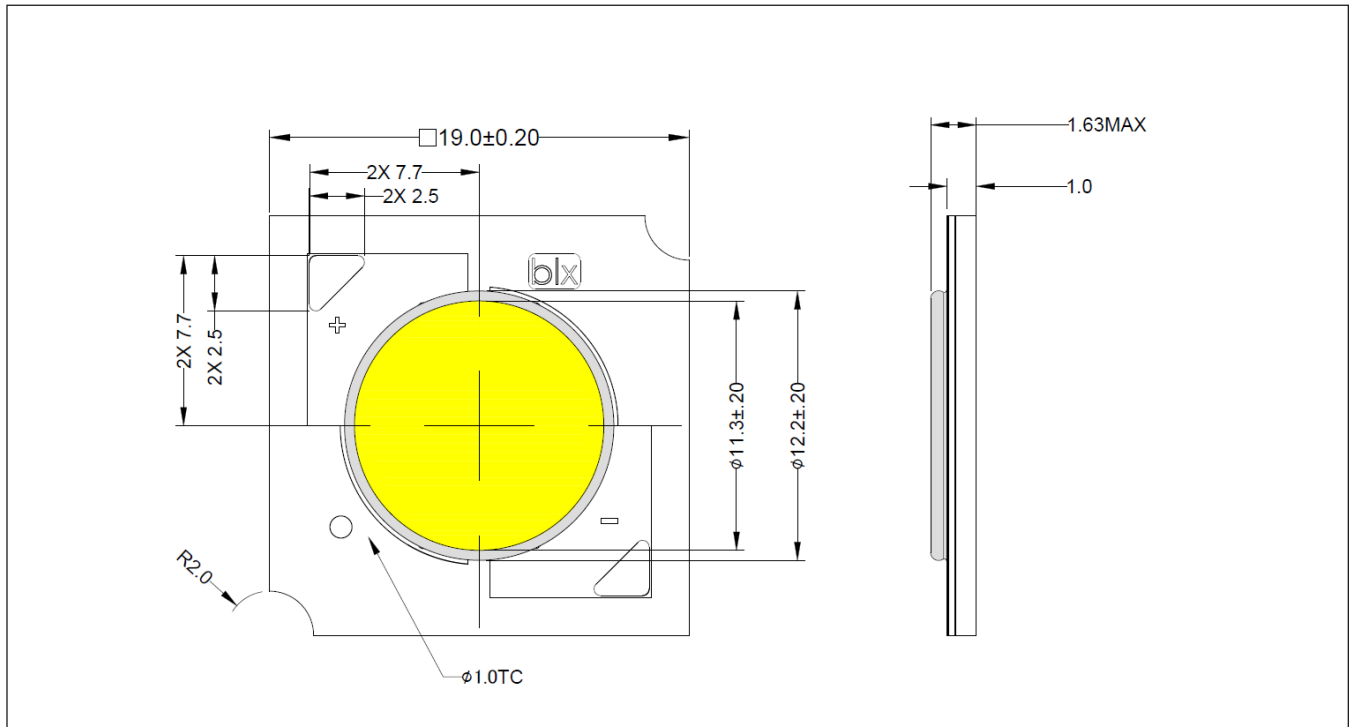

Notes for Figure 11:

1. Drawings are not to scale.
2. Drawing dimensions are in millimeters.
3. Solder pads are labeled "+" and "-" to denote positive and negative polarity, respectively.
4. Unless otherwise specified, tolerances are ± 0.1 mm.
5. Refer to Application Notes AN101 for product handling, mounting and heat sink recommendations.
6. The optical center of the LED Array is nominally defined by the mechanical center of the array to a tolerance of ± 0.2 mm.
7. Bridgelux maintains a flatness of 0.10mm across the mounting surface of the array.

Color Binning Information

Figure 12: Warm and Neutral White Test Bins in xy Color Space **Figure 13: Cool White Test Bins in xy Color Space**

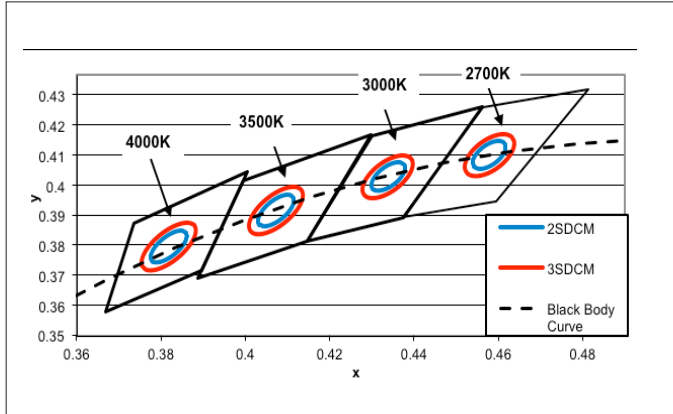

Note: Pulsed Test Conditions, $T_c = 25^\circ\text{C}$

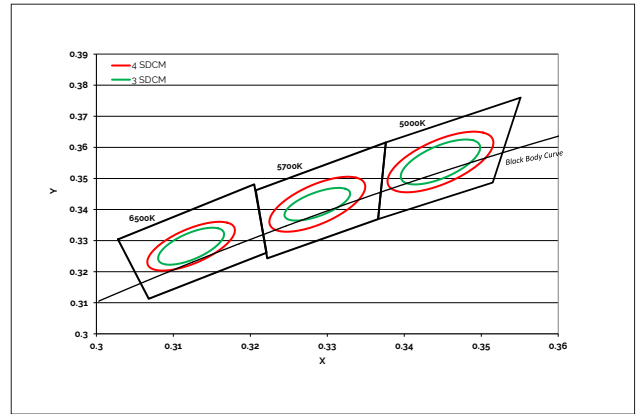

Note: Pulsed Test Conditions, $T_c = 85^\circ\text{C}$

Table 7: Warm and Neutral White xy Bin Coordinates and Associated Typical CCT

Bin Code	2700K	3000K	3500K	4000K
ANSI Bin (for reference only)	(2580K - 2870K)	(2870K - 3220K)	(3220K - 3710K)	(3710K - 4260K)
83 (3 SDCM)	(2651K - 2794K)	(2968K - 3136K)	(3369K - 3586K)	(3851K - 4130K)
82 (2 SDCM)	(2674K - 2769K)	(2995K - 3107K)	(3404K - 3548K)	(3895K - 4081K)
Center Point (x,y)	(0.4578, 0.4101)	(0.4338, 0.403)	(0.4073, 0.3917)	(0.3818, 0.3797)

Table 8: Cool White xy Bin Coordinates and Associated Typical CCT (product is hot targeted to $T_c = 85^\circ\text{C}$)

Bin Code	5000K	5700K	6500K
ANSI Bin (for reference only)	(4745K - 5311K)	(5312K - 6022K)	(6022K - 7042K)
84 (4 SDCM)	(4801K - 5282K)	(5395K - 5970K)	(6200K - 6910K)
83 (3 SDCM)	(4835K - 5215K)	(5460K - 5891K)	(6279K - 6811K)
Center Point (x,y)	(0.3447, 0.3553)	(0.3287, 0.3417)	(0.3123, 0.3282)

Note for Table 7-8:

1. Bridgelux maintains a tolerance of +/- 0.007 on x and y color coordinates in the CIE 1931 color Space.

Packaging and Labeling

Figure 14: V11 HD Packaging Tube

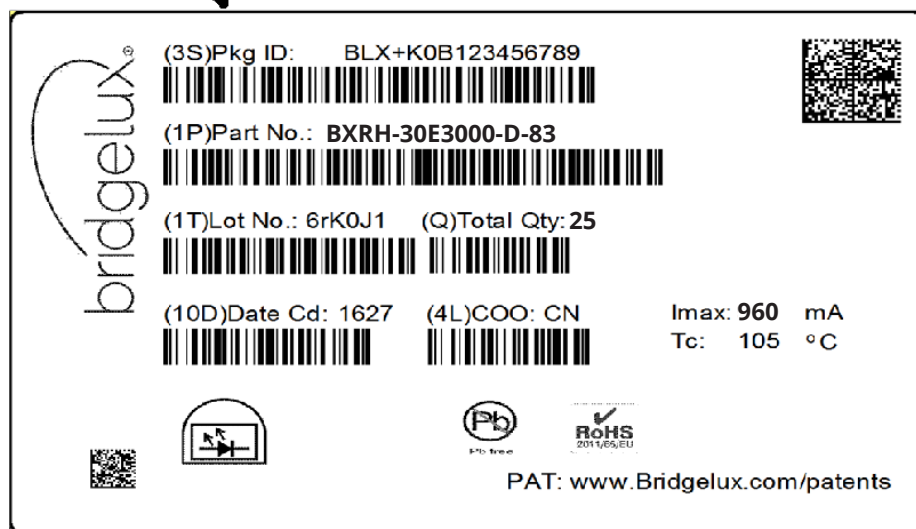

Box Label

Commercial Invoice
and Packing list



Notes for Figure 14:

1. Each tube holds 25 V11 HD COB arrays.
2. One tube is sealed in an anti-static bag. Four bags are placed in a shipping box. Depending on quantities ordered, a bigger shipping box, containing four boxes may be used to ship products.
3. Each bag and box is to be labeled as shown above.
4. Dimensions for each tube are 21.3 (W) x 9.5 (H) x 505 (L) mm. Dimensions for the anti-static bag are 100 (W) x 625 (L) x 0.075 (T) mm. Dimensions for the shipping box are 58.7 x 13.3 x 7.9 cm

Packaging and Labeling

Figure 15: V Series HD Product Labeling

Bridgelux COB arrays have laser markings on the back side of the substrate to help with product identification. In addition to the product identification markings, Bridgelux COB arrays also contain markings for internal Bridgelux manufacturing use only. The image below shows which markings are for customer use and which ones are for Bridgelux internal use only. The Bridgelux internal manufacturing markings are subject to change without notice, however these will not impact the form, function or performance of the COB array.

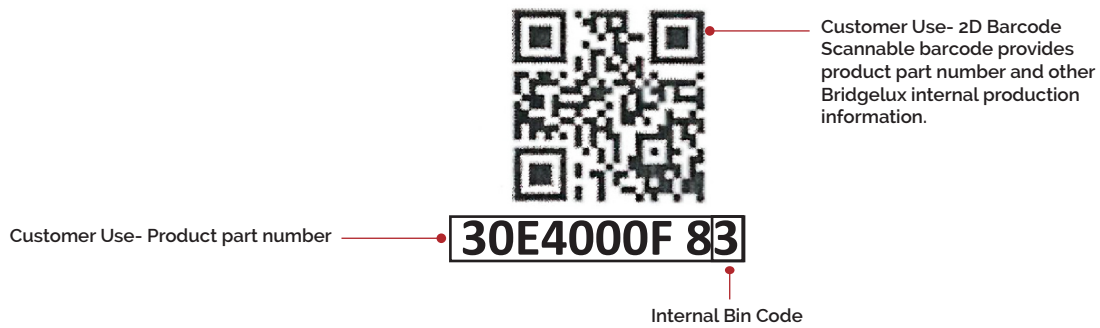

Design Resources

Application Notes

Bridgelux has developed a comprehensive set of application notes and design resources to assist customers in successfully designing with the V Series product family of LED array products. For all available application notes visit www.bridgelux.com.

Optical Source Models

Optical source models and ray set files are available for all Bridgelux products. For a list of available formats, visit www.bridgelux.com.

3D CAD Models

Three dimensional CAD models depicting the product outline of all Bridgelux V Series HD LED arrays are available in both IGS and STEP formats. Please contact your Bridgelux sales representative for assistance.

LM80

LM80 testing has been completed and the LM80 report is now available. Please contact your Bridgelux sales representatives for LM-80 report.

Precautions

CAUTION: CHEMICAL EXPOSURE HAZARD

Exposure to some chemicals commonly used in luminaire manufacturing and assembly can cause damage to the LED array. Please consult Bridgelux Application Note AN101 for additional information.

CAUTION: RISK OF BURN

Do not touch the V Series HD LED array during operation. Allow the array to cool for a sufficient period of time before handling. The V Series HD LED array may reach elevated temperatures such that could burn skin when touched.

CAUTION

CONTACT WITH LIGHT EMITTING SURFACE (LES)

Avoid any contact with the LES. Do not touch the LES of the LED array or apply stress to the LES (yellow phosphor resin area). Contact may cause damage to the LED array.

Optics and reflectors must not be mounted in contact with the LES (yellow phosphor resin area).

Disclaimers

MINOR PRODUCT CHANGE POLICY

The rigorous qualification testing on products offered by Bridgelux provides performance assurance. Slight cosmetic changes that do not affect form, fit, or function may occur as Bridgelux continues product optimization.

STANDARD TEST CONDITIONS

Unless otherwise stated, array testing is performed at the nominal drive current.

About Bridgelux: Bridging Light and Life™

At Bridgelux, we help companies, industries and people experience the power and possibility of light. Since 2002, we've designed LED solutions that are high performing, energy efficient, cost effective and easy to integrate. Our focus is on light's impact on human behavior, delivering products that create better environments, experiences and returns—both experiential and financial. And our patented technology drives new platforms for commercial and industrial luminaires.

For more information about the company, please visit
bridgelux.com
twitter.com/Bridgelux
facebook.com/Bridgelux
youtube.com/user/Bridgelux
linkedin.com/company/bridgelux-inc-_2
WeChat ID: BridgeluxInChina



46410 Fremont Boulevard
Fremont, CA 94538 USA
Tel (925) 583-8400
www.bridgelux.com

© 2023 Bridgelux, Inc. All rights reserved. Product specifications are subject to change without notice. Bridgelux, the Bridgelux stylized logo design, Vero, V Series and V Series HD are registered trademarks, and Decor Series is a trademark of Bridgelux, Inc. All other trademarks are the property of their respective owners.

Bridgelux Gen 8 V11 HD Array Series Product Data Sheet DS409 Rev. D (10/2023)