

# Bridgelux® CSP 1919 Series

Product Data Sheet DS954

# Introduction

CSP 1919

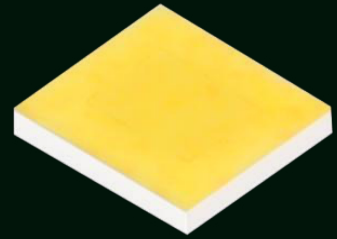

The Bridgelux Chip Scale Package (CSP) 1919 LED offers exceptional performance in an ultra compact size. This CSP LED is hot-color targeted which ensures that the LEDs fall within their specified color bin at the typical application conditions of 85°C. With its superior performance without bonding wires and ability to assemble a densely populated and high luminous flux LED board, the CSP 1919 provides unparalleled design-in flexibility for indoor and outdoor lighting applications. The CSP 1919 is ideal as a drop in replacement for emitters with an industry standard 1.9mm x 1.9mm footprint.

## Features

- Competitive efficacy and lumen per dollar
- Industry-standard 1919 footprint, 1-sided emitter
- Excellent color maintenance
- Compatible with SMT
- Superior luminous flux at maximum current for reduced LED count
- Hot-color targeting ensures that color is within the ANSI bin at the typical application conditions of 85°C
- Enables 3- and 5-step MacAdam ellipse custom binning kits
- 120 degrees viewing angle
- Multiple CCT and CRI configurations for a wide range of lighting applications

## Benefits

- Lower operating and manufacturing cost
- Ease of design and rapid go-to-market
- Uniform consistent white light
- Reliable and constant white point
- Environmentally friendly, complies with standards
- Design flexibility

# Contents

Product Feature Map	2
Product Nomenclature	2
Product Test Conditions	2
Product Selection Guide	3
Performance at Commonly Used Drive Currents	5
Electrical and Thermal Characteristics	10
Absolute Maximum Ratings	11
Product Bin Definitions	12
Performance Curves	15
Typical Radiation Pattern	18
Typical Color Spectrum	19
Mechanical Dimensions	20
Reliability	21
Reflowing Characteristics	22
Packaging	23
Design Resources	25
Precautions	25
Disclaimers	25
About Bridgelux	26

# Product Feature Map

Bridgelux CSP LED products offer exceptional performance and color quality all in a highly reliable, cost effective, compact package. Our CSP products come in industry standard package sizes and follow ANSI binning standards.

These LEDs are optimized for cost and performance, helping to ensure highly competitive system lumen per dollar performance while addressing the stringent efficacy and reliability standards required for modern lighting applications.

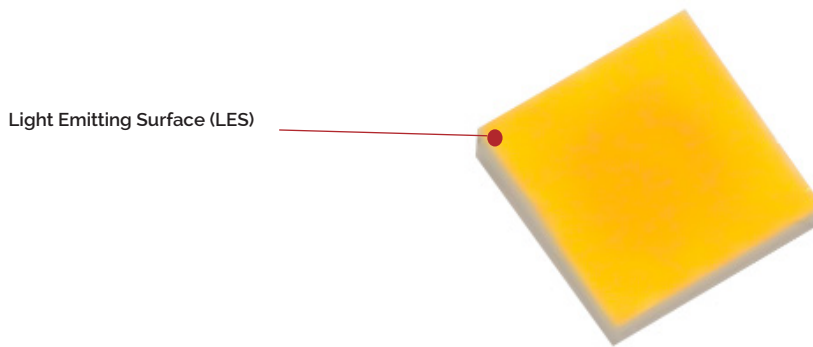

## Product Nomenclature

The part number designation for Bridgelux CSP 1919 is explained as follows:

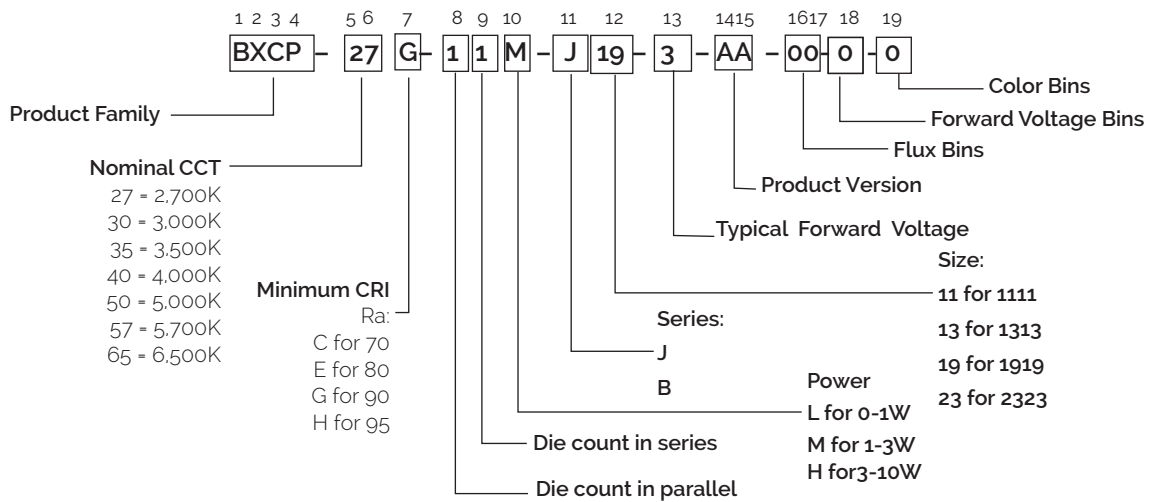

## Product Test Conditions

Bridgelux CSP 1919 LEDs are tested and binned with a 10ms pulse of 350mA at  $T_j$  (junction temperature) =  $T_{sp}$  (solder point temperature) = 85°C. Luminous flux, color and forward voltage are binned at  $T_j = T_{sp} = 85^\circ\text{C}$ .

# Product Selection Guide

The following product configurations are available:

**Table 1:** Selection Guide, Pulsed Measurement Data at 500mA ( $T_j = T_{sp} = 25^\circ\text{C}$ )

Part Number <sup>1,5</sup>	Nominal CCT <sup>2</sup> (K)	CRI <sup>3,4</sup>	Nominal Drive Current (mA)	Forward Voltage <sup>4</sup> (V)			Typical Pulsed Flux <sup>4</sup> (lm)	Typical Power (W)	Typical Efficacy (lm/W)
				Min	Typical	Max			
BXCP-30C-11M-J19-3-A1-00-0-0	3000	70	500	2.80	3.00	3.30	240	1.50	160
BXCP-40C-11M-J19-3-A1-00-0-0	4000	70	500	2.80	3.00	3.30	252	1.50	168
BXCP-50C-11M-J19-3-A1-00-0-0	5000	70	500	2.80	3.00	3.30	252	1.50	168
BXCP-57C-11M-J19-3-A1-00-0-0	5700	70	500	2.80	3.00	3.30	252	1.50	168
BXCP-65C-11M-J19-3-A1-00-0-0	6500	70	500	2.80	3.00	3.30	252	1.50	168
BXCP-27E-11M-J19-3-A1-00-0-0	2700	80	500	2.80	3.00	3.30	204	1.50	136
BXCP-30E-11M-J19-3-A1-00-0-0	3000	80	500	2.80	3.00	3.30	215	1.50	143
BXCP-40E-11M-J19-3-A1-00-0-0	4000	80	500	2.80	3.00	3.30	234	1.50	156
BXCP-50E-11M-J19-3-A1-00-0-0	5000	80	500	2.80	3.00	3.30	234	1.50	156
BXCP-57E-11M-J19-3-A1-00-0-0	5700	80	500	2.80	3.00	3.30	234	1.50	156
BXCP-65E-11M-J19-3-A1-00-0-0	6500	80	500	2.80	3.00	3.30	234	1.50	156
BXCP-27G-11M-J19-3-A1-00-0-0	2700	90	500	2.80	3.00	3.30	173	1.50	115
BXCP-30G-11M-J19-3-A1-00-0-0	3000	90	500	2.80	3.00	3.30	182	1.50	121
BXCP-40G-11M-J19-3-A1-00-0-0	4000	90	500	2.80	3.00	3.30	195	1.50	130
BXCP-50G-11M-J19-3-A1-00-0-0	5000	90	500	2.80	3.00	3.30	195	1.50	130
BXCP-57G-11M-J19-3-A1-00-0-0	5700	90	500	2.80	3.00	3.30	195	1.50	130
BXCP-65G-11M-J19-3-A1-00-0-0	6500	90	500	2.80	3.00	3.30	195	1.50	130
BXCP-27H-11M-J19-3-A1-00-0-0	2700	95	500	2.80	3.00	3.30	155	1.50	103
BXCP-30H-11M-J19-3-A1-00-0-0	3000	95	500	2.80	3.00	3.30	163	1.50	109
BXCP-40H-11M-J19-3-A1-00-0-0	4000	95	500	2.80	3.00	3.30	183	1.50	122
BXCP-50H-11M-J19-3-A1-00-0-0	5000	95	500	2.80	3.00	3.30	183	1.50	122
BXCP-57H-11M-J19-3-A1-00-0-0	5700	95	500	2.80	3.00	3.30	183	1.50	122
BXCP-65H-11M-J19-3-A1-00-0-0	6500	95	500	2.80	3.00	3.30	183	1.50	122

Notes for Table 1:

- The last 6 characters (including hyphens '-') refer to nominal flux, nominal forward voltage, and color bins, respectively. "00-0-0" denotes the full distribution of flux, forward voltage, and 5 SDCM color.  
Example: BXCP-27G-11M-J19-3-A1-00-0-0 refers to the full distribution of flux, forward voltage, and color within a 2700K 5-step ANSI standard chromaticity region with a minimum of 90 CRI.
- Product CCT is hot targeted at  $T_{sp} = 85^\circ\text{C}$ . Nominal CCT as defined by ANSI C78.377-2011.
- Listed CRIs are minimum values and include test tolerance.
- Products tested under pulsed condition (10ms pulse width) at nominal drive current where  $T_j = T_{sp} = 25^\circ\text{C}$ .
- Bridgelux maintains a  $\pm 7.5\%$  tolerance on luminous flux measurements,  $\pm 0.1\text{V}$  tolerance on forward voltage measurements, and  $\pm 2$  tolerance on CRI measurements for the CSP.
- Refer to Table 6 and Table 7 for Bridgelux CSP Luminous Flux Binning and Forward Voltage Binning information.

# Product Selection Guide

**Table 2:** Selection Guide, Pulsed Measurement Data at 500mA ( $T_j = T_{sp} = 85^\circ\text{C}$ )

Part Number <sup>1,5</sup>	Nominal CCT <sup>2</sup> (K)	CRI <sup>3,4</sup>	Nominal Drive Current (mA)	Forward Voltage <sup>4</sup> (V)			Typical Pulsed Flux <sup>4</sup> (lm)	Typical Power (W)	Typical Efficacy (lm/W)
				Min	Typical	Max			
BXCP-30C-11M-J19-3-A1-00-0-0	3000	70	500	2.70	2.90	3.20	220	145	152
BXCP-40C-11M-J19-3-A1-00-0-0	4000	70	500	2.70	2.90	3.20	231	145	159
BXCP-50C-11M-J19-3-A1-00-0-0	5000	70	500	2.70	2.90	3.20	231	145	159
BXCP-57C-11M-J19-3-A1-00-0-0	5700	70	500	2.70	2.90	3.20	231	145	159
BXCP-65C-11M-J19-3-A1-00-0-0	6500	70	500	2.70	2.90	3.20	231	145	159
BXCP-27E-11M-J19-3-A1-00-0-0	2700	80	500	2.70	2.90	3.20	188	145	130
BXCP-30E-11M-J19-3-A1-00-0-0	3000	80	500	2.70	2.90	3.20	197	145	136
BXCP-40E-11M-J19-3-A1-00-0-0	4000	80	500	2.70	2.90	3.20	215	145	148
BXCP-50E-11M-J19-3-A1-00-0-0	5000	80	500	2.70	2.90	3.20	215	145	148
BXCP-57E-11M-J19-3-A1-00-0-0	5700	80	500	2.70	2.90	3.20	215	145	148
BXCP-65E-11M-J19-3-A1-00-0-0	6500	80	500	2.70	2.90	3.20	215	145	148
BXCP-27G-11M-J19-3-A1-00-0-0	2700	90	500	2.70	2.90	3.20	159	145	110
BXCP-30G-11M-J19-3-A1-00-0-0	3000	90	500	2.70	2.90	3.20	167	145	115
BXCP-40G-11M-J19-3-A1-00-0-0	4000	90	500	2.70	2.90	3.20	179	145	123
BXCP-50G-11M-J19-3-A1-00-0-0	5000	90	500	2.70	2.90	3.20	179	145	123
BXCP-57G-11M-J19-3-A1-00-0-0	5700	90	500	2.70	2.90	3.20	179	145	123
BXCP-65G-11M-J19-3-A1-00-0-0	6500	90	500	2.70	2.90	3.20	179	145	123
BXCP-27H-11M-J19-3-A1-00-0-0	2700	95	500	2.70	2.90	3.20	142	145	98
BXCP-30H-11M-J19-3-A1-00-0-0	3000	95	500	2.70	2.90	3.20	150	145	103
BXCP-40H-11M-J19-3-A1-00-0-0	4000	95	500	2.70	2.90	3.20	168	145	116
BXCP-50H-11M-J19-3-A1-00-0-0	5000	95	500	2.70	2.90	3.20	168	145	116
BXCP-57H-11M-J19-3-A1-00-0-0	5700	95	500	2.70	2.90	3.20	168	145	116
BXCP-65H-11M-J19-3-A1-00-0-0	6500	95	500	2.70	2.90	3.20	168	145	116

Notes for Table 2:

- The last 6 characters (including hyphens '-') refer to nominal flux, nominal forward voltage, and color bins, respectively. "00-0-0" denotes the full distribution of flux, forward voltage, and 5 SDCM color.  
Example: BXCP-27G-11M-J19-3-A1-00-0-0 refers to the full distribution of flux, forward voltage, and color within a 2700K 5-step ANSI standard chromaticity region with a minimum of 90 CRI.
- Product CCT is hot targeted at  $T_{sp} = 85^\circ\text{C}$ . Nominal CCT as defined by ANSI C78.377-2011.
- Listed CRIs are minimum values and include test tolerance.
- Bridgelux maintains a  $\pm 7.5\%$  tolerance on luminous flux measurements,  $\pm 0.1\text{V}$  tolerance on forward voltage measurements, and  $\pm 2$  tolerance on CRI measurements for the CSP.
- Refer to Table 6 and Table 7 for Bridgelux CSP Luminous Flux Binning and Forward Voltage Binning information.
- Products tested under pulsed condition (10ms pulse width) at nominal drive current where  $T_j = T_{sp} = 85^\circ\text{C}$ .

# Performance at Commonly Used Drive Currents

CSP 1919 LEDs specifications at nominal drive current are shown in Table 1 and Table 2. CSP 1919 may also be driven at other drive currents dependent on specific application design requirements. The performance at any drive current can be derived from the current vs. voltage characteristics shown in Figure 2 and the relative luminous flux vs. current characteristics shown in Figure 3. The performance at commonly used drive currents is summarized in Table 3.

**Table 3:** Performance at Commonly Used Drive Currents

Part Number	CRI	Drive Current <sup>1</sup> (mA)	Typical $V_f$ $T_{sp} = 25^\circ\text{C}$ (V)	Typical Power $T_{sp} = 25^\circ\text{C}$ (W)	Typical Pulsed Flux <sup>2</sup> $T_{sp} = 25^\circ\text{C}$ (lm)	Typical Pulsed Flux <sup>3</sup> $T_{sp} = 85^\circ\text{C}$ (lm)	Typical Efficacy $T_{sp} = 25^\circ\text{C}$ (lm/W)
BXCP-30C-11M-J19-3-A1-00-0-0	70	50	2.6	0.1	28	26	214
		250	2.8	0.7	131	120	185
		350	2.9	1.0	176	162	173
		<b>500</b>	<b>3.0</b>	<b>1.5</b>	<b>240</b>	<b>220</b>	<b>160</b>
		700	3.1	2.2	317	291	146
		900	3.2	2.9	384	352	132
		1200	3.4	4.1	479	440	118
BXCP-40C-11M-J19-3-A1-00-0-0	70	50	2.6	0.1	30	27	224
		250	2.8	0.7	137	126	194
		350	2.9	1.0	185	170	182
		<b>500</b>	<b>3.0</b>	<b>1.5</b>	<b>252</b>	<b>231</b>	<b>168</b>
		700	3.1	2.2	332	305	153
		900	3.2	2.9	403	370	139
		1200	3.4	4.1	503	461	124
BXCP-50C-11M-J19-3-A1-00-0-0	70	50	2.6	0.1	30	27	224
		250	2.8	0.7	137	126	194
		350	2.9	1.0	185	170	182
		<b>500</b>	<b>3.0</b>	<b>1.5</b>	<b>252</b>	<b>231</b>	<b>168</b>
		700	3.1	2.2	332	305	153
		900	3.2	2.9	403	370	139
		1200	3.4	4.1	503	461	124
BXCP-57C-11M-J19-3-A1-00-0-0	70	50	2.6	0.1	30	27	224
		250	2.8	0.7	137	126	194
		350	2.9	1.0	185	170	182
		<b>500</b>	<b>3.0</b>	<b>1.5</b>	<b>252</b>	<b>231</b>	<b>168</b>
		700	3.1	2.2	332	305	153
		900	3.2	2.9	403	370	139
		1200	3.4	4.1	503	461	124
BXCP-65C-11M-J19-3-A1-00-0-0	70	50	2.6	0.1	30	27	224
		250	2.8	0.7	137	126	194
		350	2.9	1.0	185	170	182
		<b>500</b>	<b>3.0</b>	<b>1.5</b>	<b>252</b>	<b>231</b>	<b>168</b>
		700	3.1	2.2	332	305	153
		900	3.2	2.9	403	370	139
		1200	3.4	4.1	503	461	124

Notes for Table 3:

1. Alternate drive currents in Table 3 are provided for reference only and are not a guarantee of performance.
2. Bridgelux maintains a  $\pm 7.5\%$  tolerance on flux measurements.
3. Typical pulsed performance values are provided as reference only and are not a guarantee of performance.

# Performance at Commonly Used Drive Currents

**Table 3:** Performance at Commonly Used Drive Currents (Continued)

Part Number	CRI	Drive Current <sup>1</sup> (mA)	Typical $V_f$ $T_{sp} = 25^\circ\text{C}$ (V)	Typical Power $T_{sp} = 25^\circ\text{C}$ (W)	Typical Pulsed Flux <sup>2</sup> $T_{sp} = 25^\circ\text{C}$ (lm)	Typical Pulsed Flux <sup>3</sup> $T_{sp} = 85^\circ\text{C}$ (lm)	Typical Efficacy $T_{sp} = 25^\circ\text{C}$ (lm/W)
BXCP-27E-11M-J19-3-A1-00-0-0	80	50	2.6	0.1	24	22	182
		250	2.8	0.7	111	102	158
		350	2.9	1.0	150	138	148
		<b>500</b>	<b>3.0</b>	<b>1.5</b>	<b>204</b>	<b>188</b>	<b>136</b>
		700	3.1	2.2	270	248	124
		900	3.2	2.9	327	300	113
		1200	3.4	4.1	408	374	100
BXCP-30E-11M-J19-3-A1-00-0-0	80	50	2.6	0.1	25	23	191
		250	2.8	0.7	117	107	166
		350	2.9	1.0	158	145	156
		<b>500</b>	<b>3.0</b>	<b>1.5</b>	<b>215</b>	<b>197</b>	<b>143</b>
		700	3.1	2.2	284	260	130
		900	3.2	2.9	344	315	118
		1200	3.4	4.1	429	393	106
BXCP-40E-11M-J19-3-A1-00-0-0	80	50	2.6	0.1	28	25	208
		250	2.8	0.7	127	117	181
		350	2.9	1.0	172	158	170
		<b>500</b>	<b>3.0</b>	<b>1.5</b>	<b>234</b>	<b>215</b>	<b>156</b>
		700	3.1	2.2	309	284	142
		900	3.2	2.9	374	344	129
		1200	3.4	4.1	467	429	115
BXCP-50E-11M-J19-3-A1-00-0-0	80	50	2.6	0.1	28	25	208
		250	2.8	0.7	127	117	181
		350	2.9	1.0	172	158	170
		<b>500</b>	<b>3.0</b>	<b>1.5</b>	<b>234</b>	<b>215</b>	<b>156</b>
		700	3.1	2.2	309	284	142
		900	3.2	2.9	374	344	129
		1200	3.4	4.1	467	429	115
BXCP-57E-11M-J19-3-A1-00-0-0	80	50	2.6	0.1	28	25	208
		250	2.8	0.7	127	117	181
		350	2.9	1.0	172	158	170
		<b>500</b>	<b>3.0</b>	<b>1.5</b>	<b>234</b>	<b>215</b>	<b>156</b>
		700	3.1	2.2	309	284	142
		900	3.2	2.9	374	344	129
		1200	3.4	4.1	467	429	115

Notes for Table 3:

1. Alternate drive currents in Table 3 are provided for reference only and are not a guarantee of performance.
2. Bridgelux maintains a  $\pm 7.5\%$  tolerance on flux measurements.
3. Typical pulsed performance values are provided as reference only and are not a guarantee of performance.



# Performance at Commonly Used Drive Currents

**Table 3:** Performance at Commonly Used Drive Currents (Continued)

Part Number	CRI	Drive Current <sup>1</sup> (mA)	Typical $V_f$ $T_{sp} = 25^\circ\text{C}$ (V)	Typical Power $T_{sp} = 25^\circ\text{C}$ (W)	Typical Pulsed Flux <sup>2</sup> $T_{sp} = 25^\circ\text{C}$ (lm)	Typical Pulsed Flux <sup>3</sup> $T_{sp} = 85^\circ\text{C}$ (lm)	Typical Efficacy $T_{sp} = 25^\circ\text{C}$ (lm/W)
BXCP-65E-11M-J19-3-A1-00-0-0	80	50	2.6	0.1	28	25	208
		250	2.8	0.7	127	117	181
		350	2.9	1.0	172	158	170
		<b>500</b>	<b>3.0</b>	<b>1.5</b>	<b>234</b>	<b>215</b>	<b>156</b>
		700	3.1	2.2	309	284	142
		900	3.2	2.9	374	344	129
		1200	3.4	4.1	467	429	115
BXCP-27G-11M-J19-3-A1-00-0-0	90	50	2.6	0.1	20	19	154
		250	2.8	0.7	94	87	134
		350	2.9	1.0	127	117	126
		<b>500</b>	<b>3.0</b>	<b>1.5</b>	<b>173</b>	<b>159</b>	<b>115</b>
		700	3.1	2.2	229	210	105
		900	3.2	2.9	277	255	96
		1200	3.4	4.1	346	317	85
BXCP-30G-11M-J19-3-A1-00-0-0	90	50	2.6	0.1	21	20	162
		250	2.8	0.7	99	91	141
		350	2.9	1.0	134	123	132
		<b>500</b>	<b>3.0</b>	<b>1.5</b>	<b>182</b>	<b>167</b>	<b>121</b>
		700	3.1	2.2	241	221	111
		900	3.2	2.9	291	268	100
		1200	3.4	4.1	364	334	90
BXCP-40G-11M-J19-3-A1-00-0-0	90	50	2.6	0.1	23	21	174
		250	2.8	0.7	106	98	151
		350	2.9	1.0	144	132	142
		<b>500</b>	<b>3.0</b>	<b>1.5</b>	<b>195</b>	<b>179</b>	<b>130</b>
		700	3.1	2.2	258	237	119
		900	3.2	2.9	313	287	108
		1200	3.4	4.1	390	358	96
BXCP-50G-11M-J19-3-A1-00-0-0	90	50	2.6	0.1	23	21	174
		250	2.8	0.7	106	98	151
		350	2.9	1.0	144	132	142
		<b>500</b>	<b>3.0</b>	<b>1.5</b>	<b>195</b>	<b>179</b>	<b>130</b>
		700	3.1	2.2	258	237	119
		900	3.2	2.9	313	287	108
		1200	3.4	4.1	390	358	96

Notes for Table 3:

1. Alternate drive currents in Table 3 are provided for reference only and are not a guarantee of performance.
2. Bridgelux maintains a  $\pm 7.5\%$  tolerance on flux measurements.
3. Typical pulsed performance values are provided as reference only and are not a guarantee of performance.

# Performance at Commonly Used Drive Currents

**Table 3:** Performance at Commonly Used Drive Currents (Continued)

Part Number	CRI	Drive Current <sup>1</sup> (mA)	Typical $V_f$ $T_{sp} = 25^\circ\text{C}$ (V)	Typical Power $T_{sp} = 25^\circ\text{C}$ (W)	Typical Pulsed Flux <sup>2</sup> $T_{sp} = 25^\circ\text{C}$ (lm)	Typical Pulsed Flux <sup>3</sup> $T_{sp} = 85^\circ\text{C}$ (lm)	Typical Efficacy $T_{sp} = 25^\circ\text{C}$ (lm/W)
BXCP-57G-11M-J19-3-A1-00-0-0	90	50	2.6	0.1	23	21	174
		250	2.8	0.7	106	98	151
		350	2.9	1.0	144	132	142
		<b>500</b>	<b>3.0</b>	<b>1.5</b>	<b>195</b>	<b>179</b>	<b>130</b>
		700	3.1	2.2	258	237	119
		900	3.2	2.9	313	287	108
		1200	3.4	4.1	390	358	96
BXCP-65G-11M-J19-3-A1-00-0-0	90	50	2.6	0.1	23	21	174
		250	2.8	0.7	106	98	151
		350	2.9	1.0	144	132	142
		<b>500</b>	<b>3.0</b>	<b>1.5</b>	<b>195</b>	<b>179</b>	<b>130</b>
		700	3.1	2.2	258	237	119
		900	3.2	2.9	313	287	108
		1200	3.4	4.1	390	358	96
BXCP-27H-11M-J19-3-A1-00-0-0	95	50	2.6	0.1	18	17	138
		250	2.8	0.7	84	77	119
		350	2.9	1.0	114	104	112
		<b>500</b>	<b>3.0</b>	<b>1.5</b>	<b>155</b>	<b>142</b>	<b>103</b>
		700	3.1	2.2	204	188	94
		900	3.2	2.9	248	227	85
		1200	3.4	4.1	309	283	76
BXCP-30H-11M-J19-3-A1-00-0-0	95	50	2.6	0.1	19	18	146
		250	2.8	0.7	89	82	126
		350	2.9	1.0	120	110	118
		<b>500</b>	<b>3.0</b>	<b>1.5</b>	<b>163</b>	<b>150</b>	<b>109</b>
		700	3.1	2.2	216	198	99
		900	3.2	2.9	262	240	90
		1200	3.4	4.1	326	299	80
BXCP-40H-11M-J19-3-A1-00-0-0	95	50	2.6	0.1	22	20	163
		250	2.8	0.7	100	91	141
		350	2.9	1.0	135	124	133
		<b>500</b>	<b>3.0</b>	<b>1.5</b>	<b>183</b>	<b>168</b>	<b>122</b>
		700	3.1	2.2	242	222	111
		900	3.2	2.9	293	269	101
		1200	3.4	4.1	365	335	90

Notes for Table 3:

1. Alternate drive currents in Table 3 are provided for reference only and are not a guarantee of performance.
2. Bridgelux maintains a  $\pm 7.5\%$  tolerance on flux measurements.
3. Typical pulsed performance values are provided as reference only and are not a guarantee of performance.

# Performance at Commonly Used Drive Currents

**Table 3:** Performance at Commonly Used Drive Currents (Continued)

Part Number	CRI	Drive Current <sup>1</sup> (mA)	Typical $V_f$ $T_{sp} = 25^\circ\text{C}$ (V)	Typical Power $T_{sp} = 25^\circ\text{C}$ (W)	Typical Pulsed Flux <sup>2</sup> $T_{sp} = 25^\circ\text{C}$ (lm)	Typical Pulsed Flux <sup>3</sup> $T_{sp} = 85^\circ\text{C}$ (lm)	Typical Efficacy $T_{sp} = 25^\circ\text{C}$ (lm/W)
BXCP-50H-11M-J19-3-A1-00-0-0	95	50	2.6	0.1	22	20	163
		250	2.8	0.7	100	91	141
		350	2.9	1.0	135	124	133
		<b>500</b>	<b>3.0</b>	<b>1.5</b>	<b>183</b>	<b>168</b>	<b>122</b>
		700	3.1	2.2	242	222	111
		900	3.2	2.9	293	269	101
		1200	3.4	4.1	365	335	90
BXCP-57H-11M-J19-3-A1-00-0-0	95	50	2.6	0.1	22	20	163
		250	2.8	0.7	100	91	141
		350	2.9	1.0	135	124	133
		<b>500</b>	<b>3.0</b>	<b>1.5</b>	<b>183</b>	<b>168</b>	<b>122</b>
		700	3.1	2.2	242	222	111
		900	3.2	2.9	293	269	101
		1200	3.4	4.1	365	335	90
BXCP-65H-11M-J19-3-A1-00-0-0	95	50	2.6	0.1	22	20	163
		250	2.8	0.7	100	91	141
		350	2.9	1.0	135	124	133
		<b>500</b>	<b>3.0</b>	<b>1.5</b>	<b>183</b>	<b>168</b>	<b>122</b>
		700	3.1	2.2	242	222	111
		900	3.2	2.9	293	269	101
		1200	3.4	4.1	365	335	90

Notes for Table 3:

1. Alternate drive currents in Table 3 are provided for reference only and are not a guarantee of performance.
2. Bridgelux maintains a  $\pm 7.5\%$  tolerance on flux measurements.
3. Typical pulsed performance values are provided as reference only and are not a guarantee of performance.

# Electrical and Thermal Characteristics

**Table 4:** Electrical and Thermal Characteristics

Part Number <sup>1</sup>	Drive Current (mA)	Forward Voltage <sup>2,3</sup> (V)			Typical Temperature Coefficient of Forward Voltage <sup>4</sup> $\Delta V_f / \Delta T$ (mV/°C)	Typical Thermal Resistance Junction to Solder Point <sup>5,6</sup> $R_{j-sp}$ (°C/W)
		Minimum	Typical	Maximum		
BXCP-xxx-11M-J19-3-A1-00-0-0	350	2.60	2.80	3.20	-1.5	3.5

Notes for Table 4:

1. The last 6 characters (including hyphens '-') refer to nominal flux, nominal forward voltage, and color bins, respectively. "00-0-0" denotes the full distribution of flux, forward voltage, and 5 SDCM color.

Example: BXCP-27G-11M-J19-3-A1-00-0-0 refers to the full distribution of flux, forward voltage, and color within a 2700K 5-step ANSI standard chromaticity region with a minimum of 90 CRI.

2. Products tested under pulsed condition (10ms pulse width) where  $T_{sp} = 85^{\circ}\text{C}$ .

3. Bridgelux maintains a tolerance of  $\pm 0.1\text{V}$  on forward voltage measurements.

4. Products measured between  $25^{\circ}\text{C}$  and  $105^{\circ}\text{C}$  under pulsed condition (10ms pulse width).

5. Thermal Resistance values based on 2700K 90 CRI product.

6. Thermal resistance value was calculated using total electrical input power; optical power was not subtracted from input power.

# Absolute Maximum Ratings

**Table 5:** Maximum Ratings

Parameter	Maximum Rating
LED Junction Temperature ( $T_j$ )	135°C
Storage Temperature	-40°C to +125°C
Operating Solder Point Temperature ( $T_{sp}$ )	-40°C to +105°C
Soldering Temperature	260°C or lower for a maximum of 10 seconds
Maximum Drive Current <sup>1</sup>	1200mA
Maximum Peak Pulsed Forward Current <sup>2</sup>	1500mA
Maximum Reverse Voltage <sup>3</sup>	-5V
Moisture Sensitivity Rating	MSL 3
Electrostatic Discharge	2kV HBM. JEDEC-JS-001-HBM and JEDEC-JS-001-2012

Notes for Table 5:

1. The maximum drive current is limited depending on the solder point temperature. Refer to Figure 7.
2. Bridgelux recommends a maximum duty cycle of 10% and pulse width of 10 ms when operating CSP LED at maximum peak pulsed current specified. Maximum peak pulsed currents indicate values where CSP LED can be driven without catastrophic failures.
3. Light emitting diodes are not designed to be driven in reverse voltage and will not produce light under this condition. Maximum rating provided for reference only.

# Product Bin Definitions

Table 6 lists the standard photometric luminous flux bins for Bridgelux CSP 1919 LEDs. Although several bins are outlined, product availability in a particular bin varies by production run and by product performance. Not all bins are available in all CCTs.

**Table 6:** Luminous Flux Bin Definitions at 350mA,  $T_{sp}=85^{\circ}\text{C}$

Bin Code	Minimum	Maximum	Unit	Condition
I1	110	120	lm	$I_F=350\text{mA}$
J1	120	130		
K1	130	140		
M1	140	150		
N1	150	160		
P1	160	170		
Q1	170	180		
R1	180	190		

Note for Table 6:

1. Bridgelux maintains a tolerance of  $\pm 7.5\%$  on luminous flux measurements.

**Table 7:** Forward Voltage Bin Definition at 350mA,  $T_{sp}=85^{\circ}\text{C}$

Bin Code	Minimum	Maximum	Unit	Condition
C	2.6	2.8	V	$I_F=350\text{mA}$
D	2.8	3.0		
E	3.0	3.2		
F	3.2	3.4		

Note for Table 7:

1. Bridgelux maintains a tolerance of  $\pm 0.1\text{V}$  on forward voltage measurements.

# Product Bin Definitions

**Table 8:** 3- and 5-step MacAdam Ellipse Color Bin Definitions ( $T_{sp}=85^{\circ}\text{C}$ )

Table 8: 3- and 5-step MacAdam Ellipse Color Bin Definitions ( $T_{sp}=85^{\circ}\text{C}$ )							
CCT	Color Space	Center Point		Major Axis	minor Axis	$\theta'$ (angle)	Color Bin <sup>(2,3)</sup>
		x	y				
2700K	2	0.4578	0.4101	0.0054	0.0028	53.70	2
	3			0.0081	0.0042		3
	5			0.0135	0.0070		5(E/F/G/H)
3000K	2	0.4338	0.4030	0.0056	0.0027	53.22	2
	3			0.0083	0.0041		3
	5			0.0139	0.0068		5(E/F/G/H)
3500K	2	0.4073	0.3917	0.0062	0.0028	54.00	2
	3			0.0093	0.0041		3
	5			0.0155	0.0069		5(E/F/G/H)
4000K	2	0.3818	0.3797	0.0063	0.0027	53.72	2
	3			0.0094	0.0040		3
	5			0.0157	0.0067		5(E/F/G/H)
5000K	2	0.3447	0.3553	0.0055	0.0024	59.62	2
	3			0.0082	0.0035		3
	5			0.0137	0.0059		5(E/F/G/H)
5700K	2	0.3287	0.3417	0.0050	0.0021	59.09	2
	3			0.0075	0.0032		3
	5			0.0124	0.0053		5(E/F/G/H)
6500K	2	0.3123	0.3282	0.0045	0.0019	58.57	2
	3			0.0067	0.0029		3
	5			0.0112	0.0048		5(E/F/G/H)

Note for Table 8:

1. Bridgelux maintains a tolerance of  $\pm 0.007$  on x and y color coordinates in the CIE 1931 color space.
2. MacAdam Ellipse Color bin code for  $\text{CRI} \geq 90$ : 2(2 SDCM)/ 3(3 SDCM)/ EFGH(5 SDCM).
3. MacAdam Ellipse Color bin code for  $\text{CRI} < 90$ : 3(3 SDCM)/ 5(5 SDCM).

# Product Bin Definitions

Figure 1: C.I.E. 1931 Chromaticity Diagram ( Color Bin Structure,  $T_{sp} = 85^{\circ}\text{C}$ )

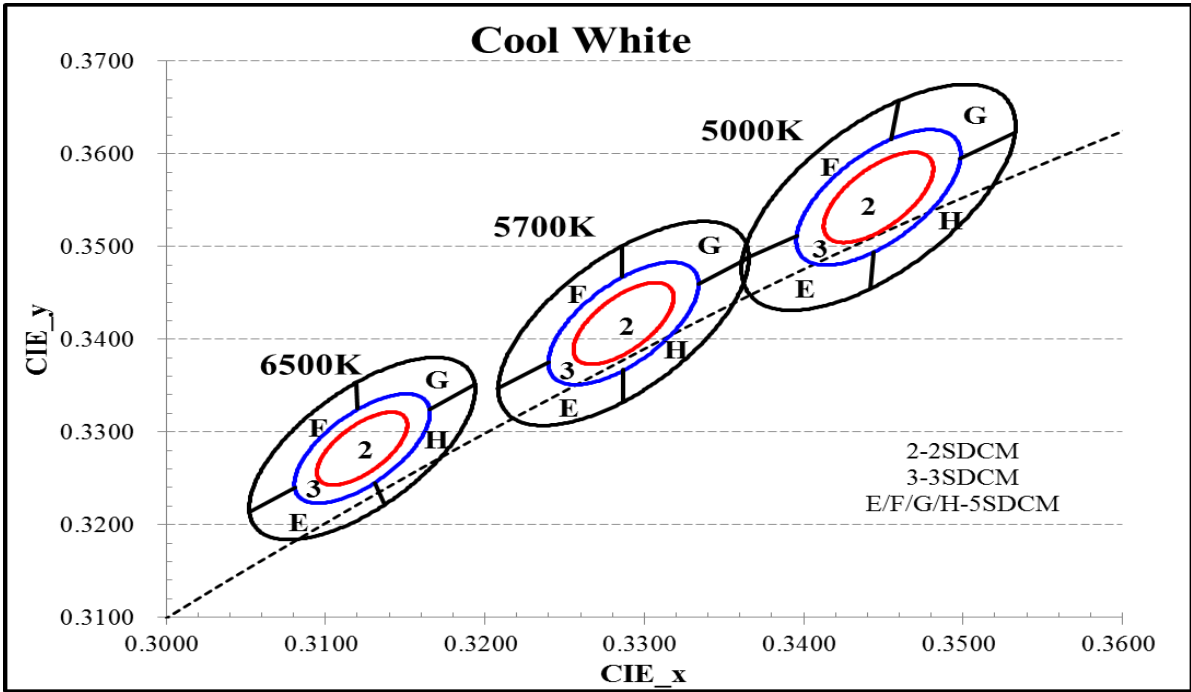
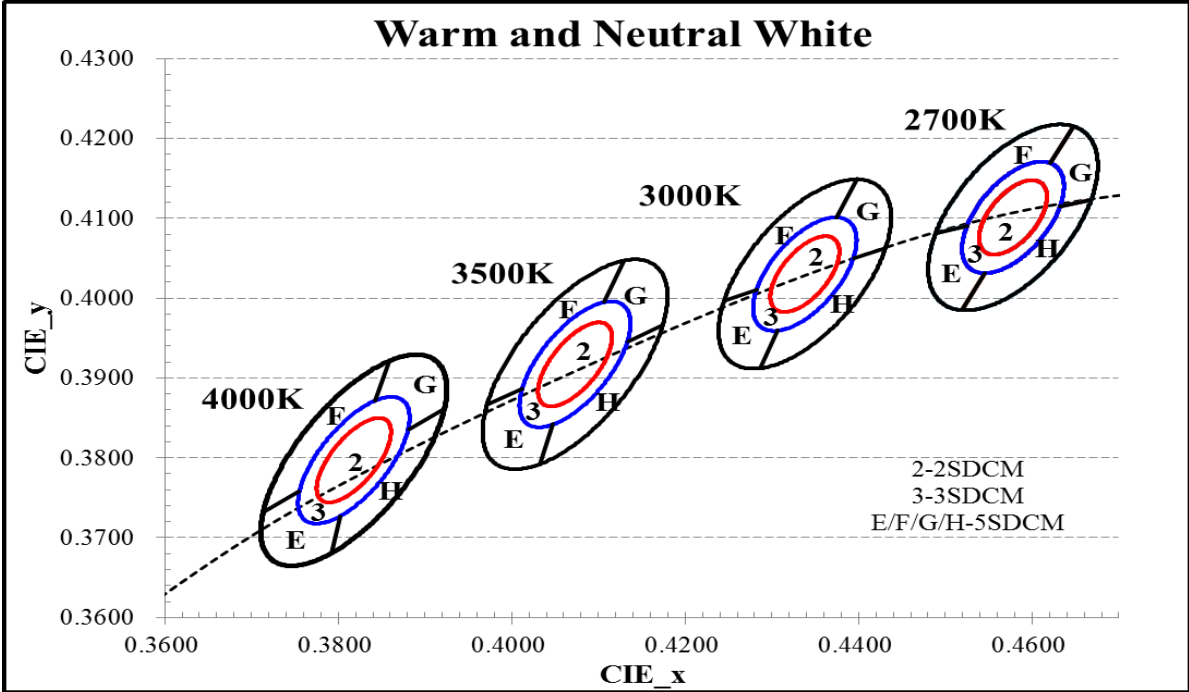



# Performance Curves

Figure 2: Drive Current vs. Voltage ( $T_{sp}=85^{\circ}\text{C}$ )

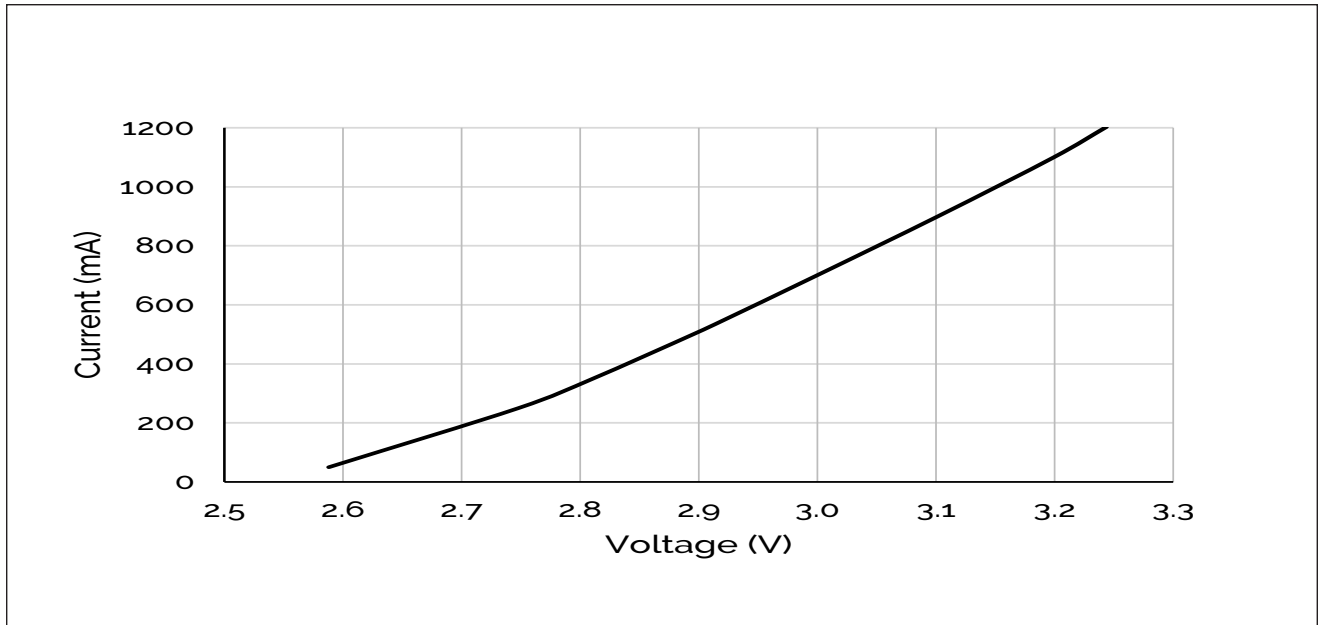
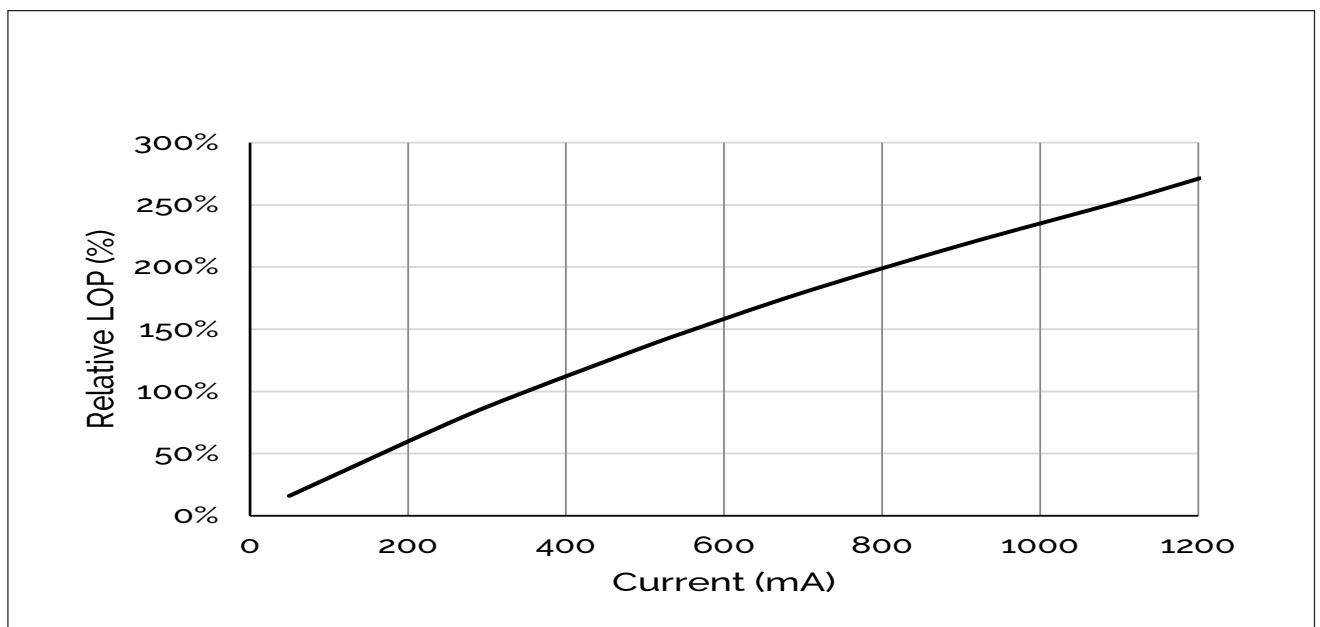

Figure 3: Typical Relative Luminous Flux vs. Drive Current ( $T_{sp}=85^{\circ}\text{C}$ )



Note for Figure 3:

1. Bridgelux does not recommend driving this CSP LED at low current ( $< 10\text{mA}$ ). Doing so may produce unpredictable results. Pulse width modulation (PWM) is recommended for dimming effects.

# Performance Curves

Figure 4: Typical Relative Flux vs. Solder Point Temperature\_350mA

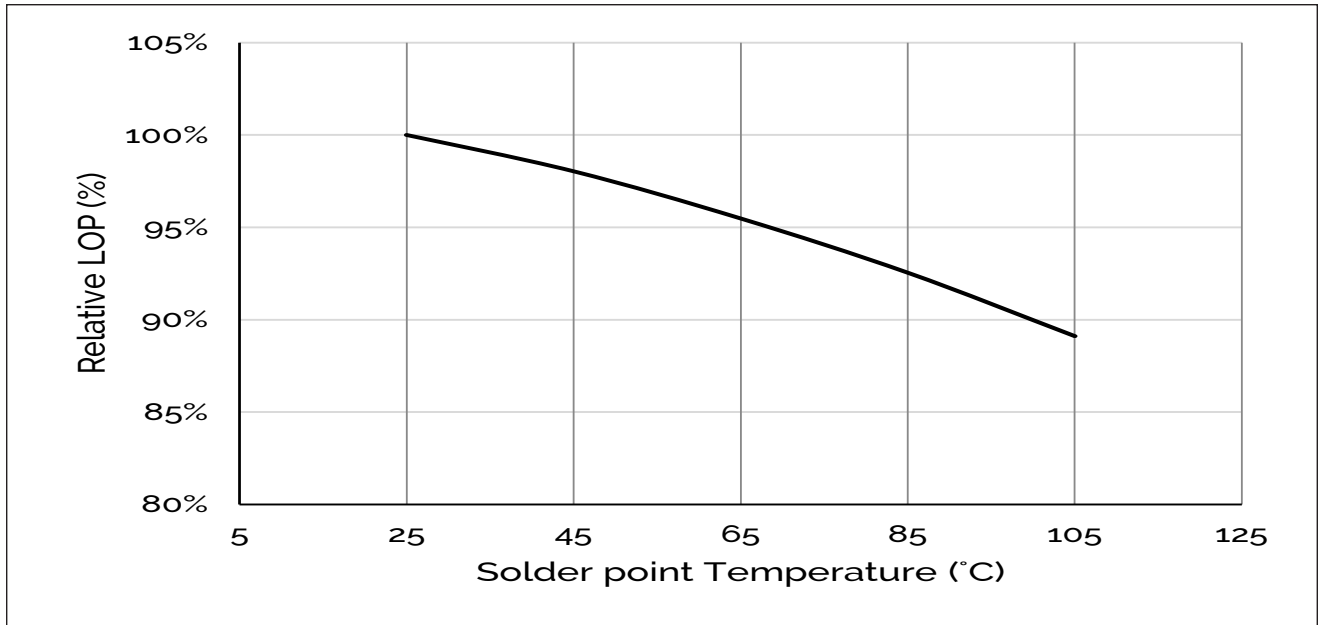
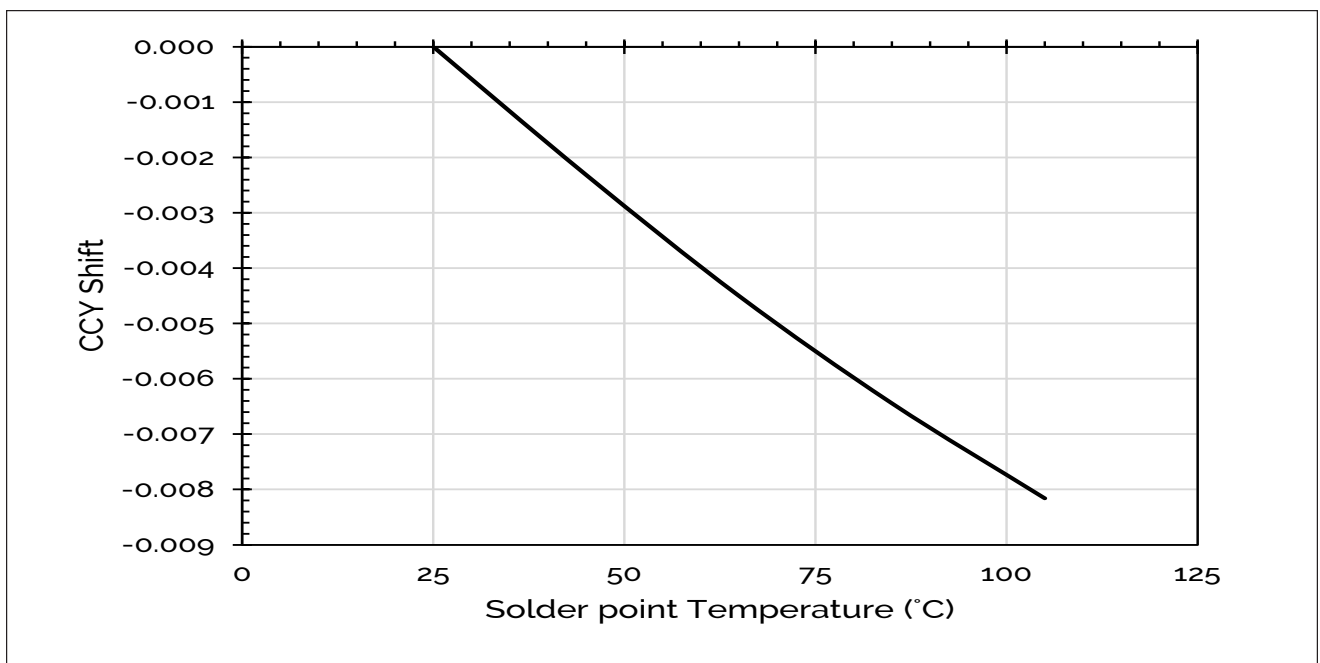

Figure 5: Typical ccy Shift vs. Solder Point Temperature\_350mA



Notes for Figures 4 & 5:

- 1.Characteristics shown for warm white based on 2700K and 90 CRI.
- 2.For other color SKUs, the shift in color will vary. Please contact your Bridgelux Sales Representative for more information.

# Performance Curves

Figure 6: Typical ccx Shift vs. Solder Point Temperature\_350mA

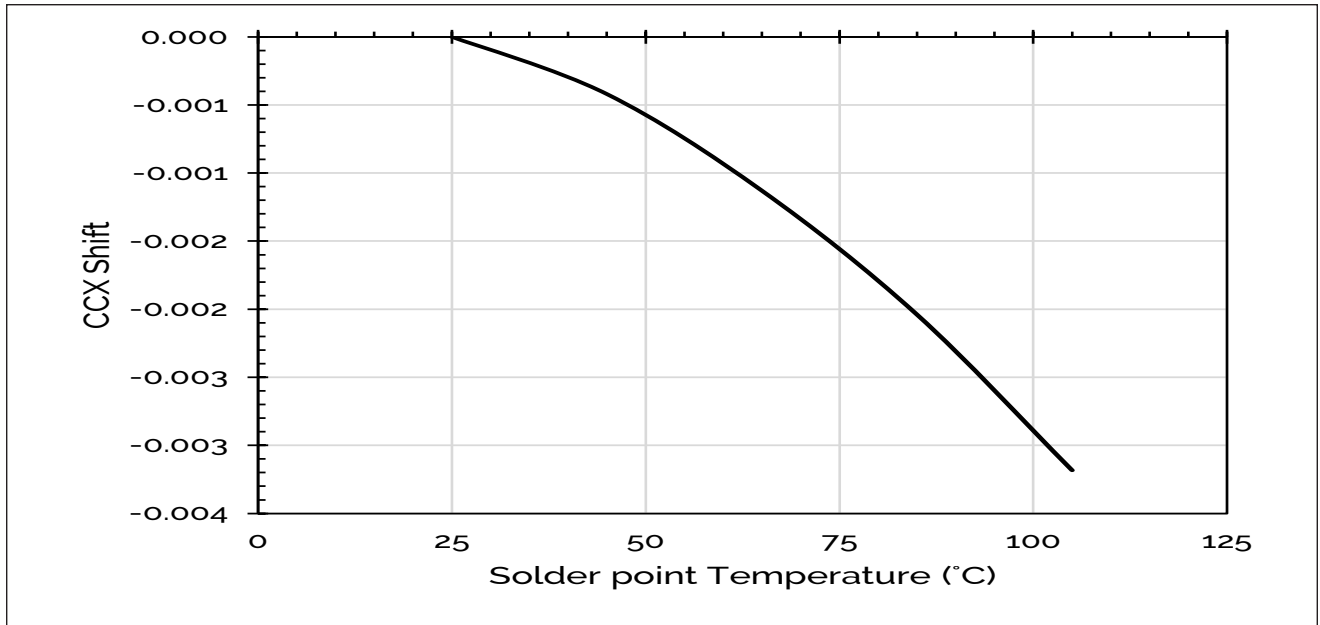

Notes for Figure 6:

1. Characteristics shown for warm white based on 2700K and 90 CRI.
2. For other color SKUs, the shift in color will vary. Please contact your Bridgelux Sales Representative for more information.

Figure 7: Drive Current vs Solder Point Temperature

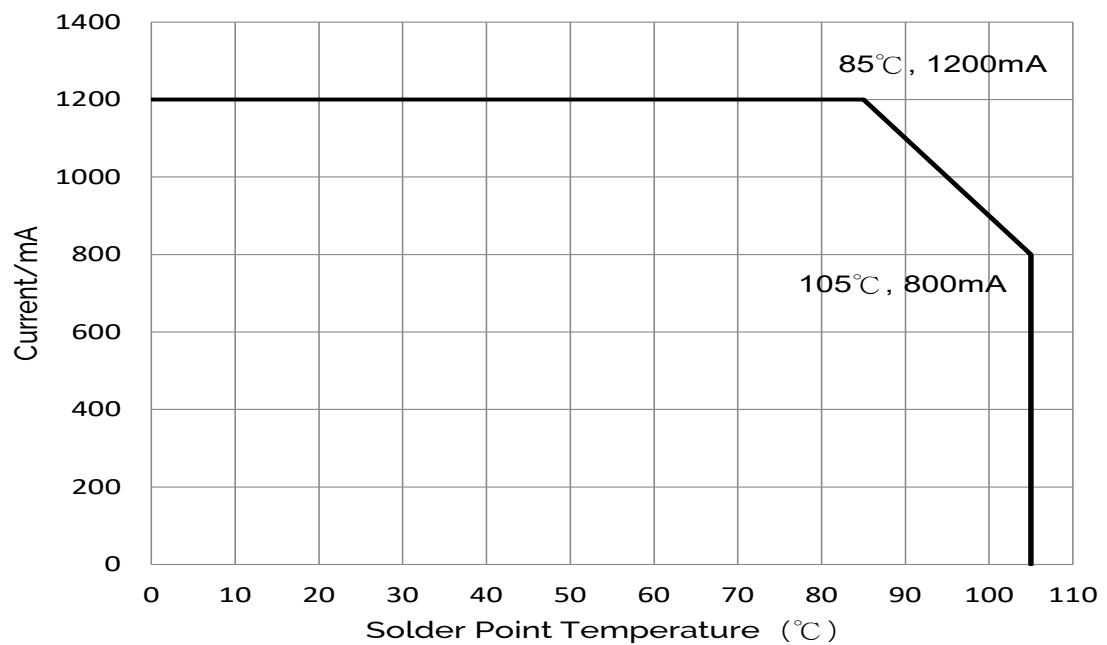

# Typical Radiation Pattern

Figure 8: Typical Spatial Radiation Pattern at 350mA,  $T_{sp} = 25^{\circ}\text{C}$

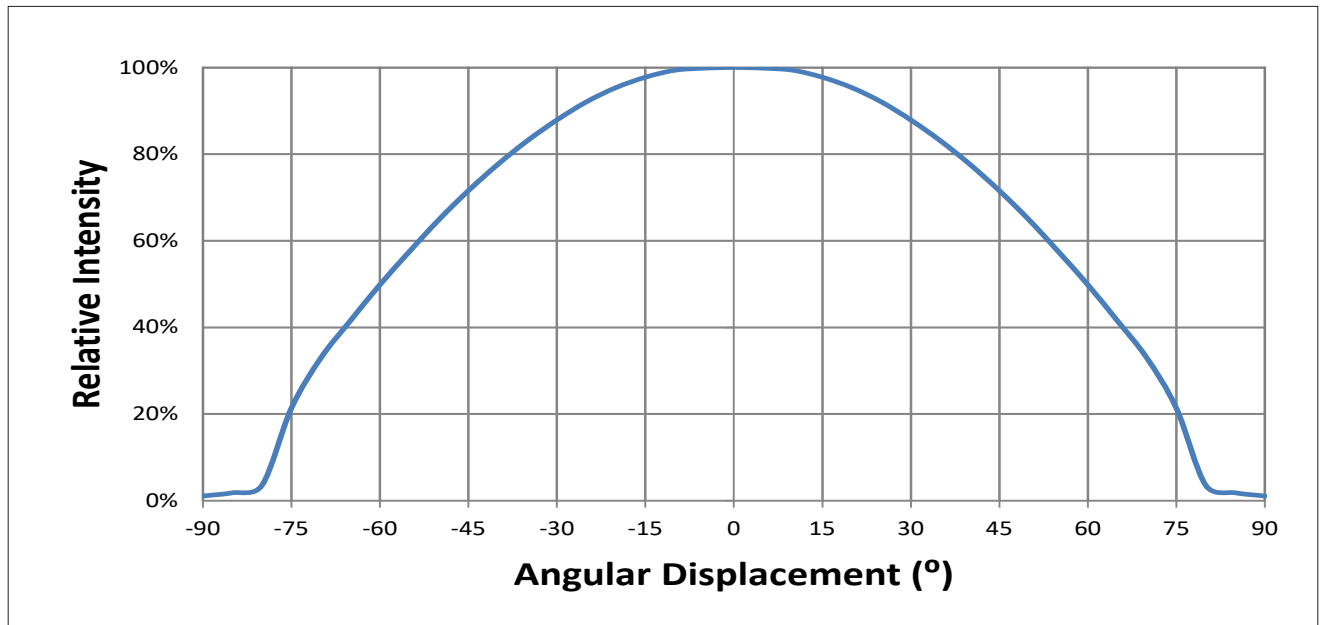

Notes for Figure 8:

1. Typical viewing angle is  $120^{\circ}$ .
2. The viewing angle is defined as the off axis angle from the centerline where  $I_v$  is  $\frac{1}{2}$  of the peak value.

Figure 9: Typical Polar Radiation Pattern at 350mA,  $T_{sp} = 25^{\circ}\text{C}$

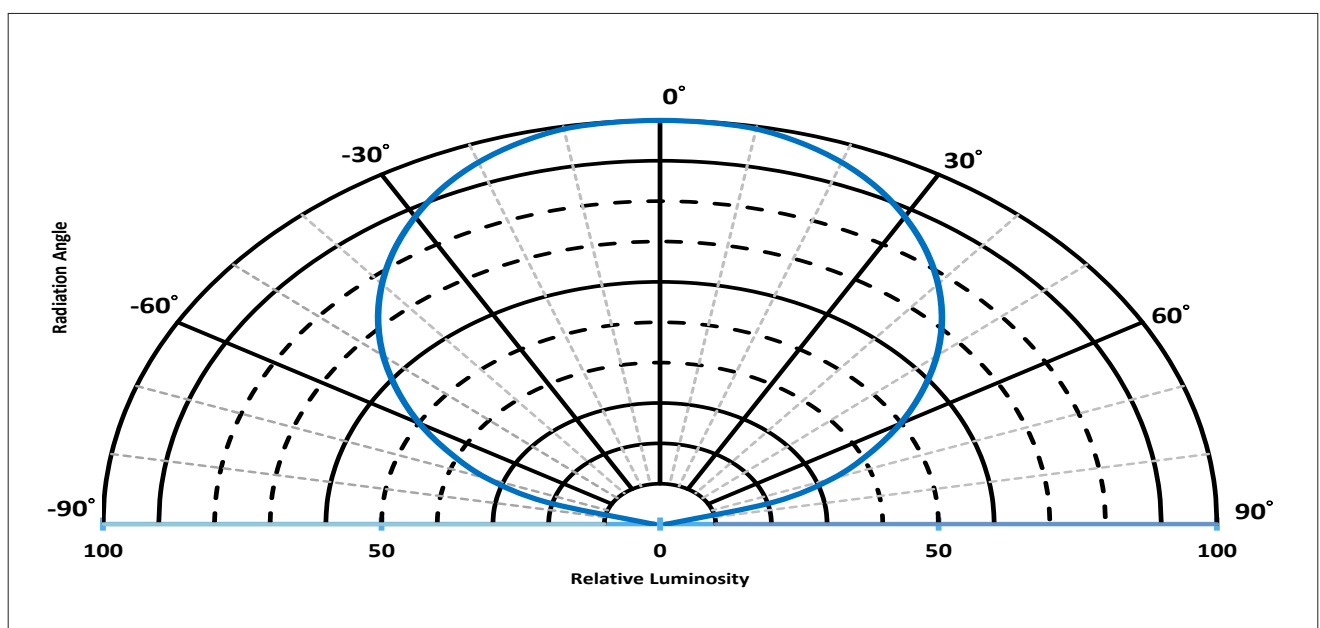

# Typical Color Spectrum

Figure 10: Typical Color Spectrum at 350mA, Tsp=85°C

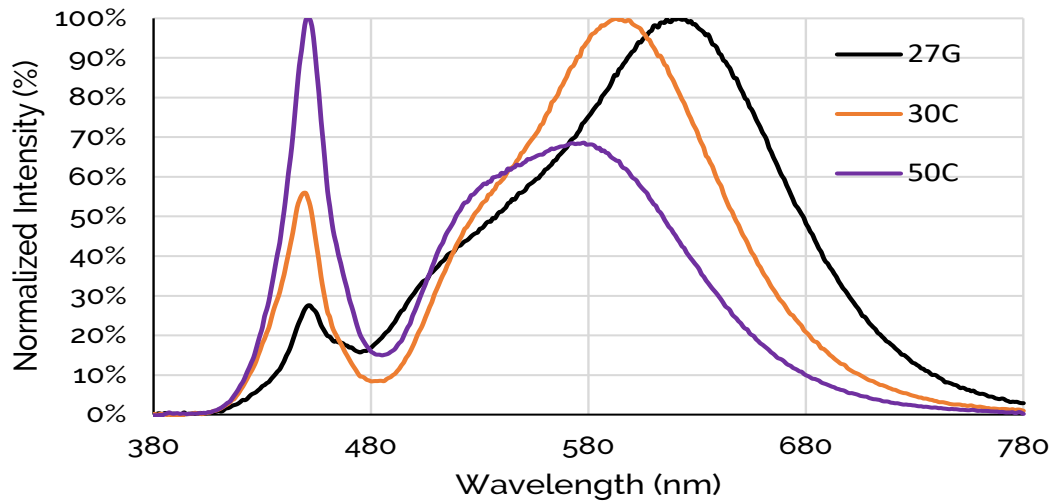

Notes for Figure 10:

1. Color spectra shown for warm white is 2700K and 90 CRI.
2. Color spectra shown for warm white is 3000K and 70 CRI.
3. Color spectra shown for cool white is 5000K and 70 CRI.

# Mechanical Dimensions

**Figure 11: Drawing for CSP 1919**

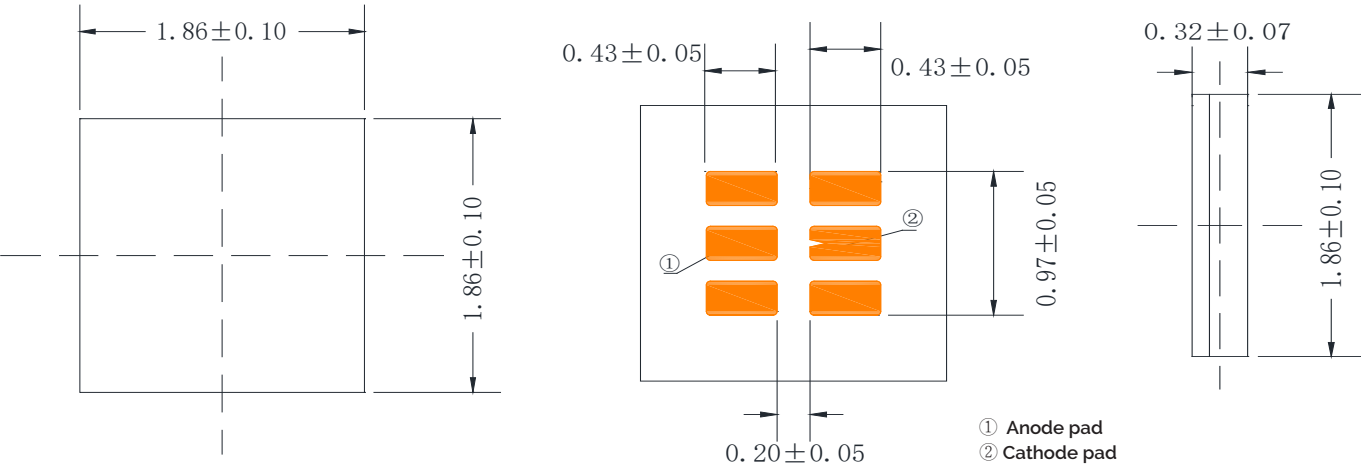

Notes for Figure 11:

1. Drawings are not to scale.
2. Drawing dimensions are in millimeters.
3. Unless otherwise specified, tolerances are  $\pm 0.10$ mm.
4. The optical center of the LED emitter is nominally defined by the mechanical center of the emitter. The light emitting surface (LES) is centered on the mechanical center of the LED emitter to a tolerance of  $\pm 0.2$  mm

## Recommended PCB Soldering Pad Pattern

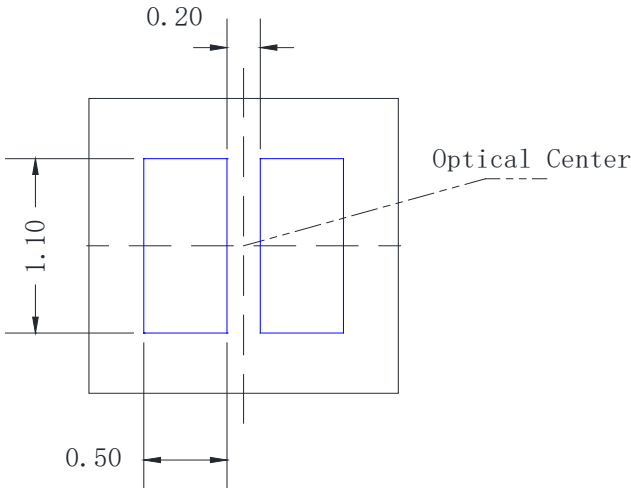

# Reliability

**Table 9: Reliability Test Items and Conditions**

No .	Items	Reference Standard	Test Conditions	Drive Current	Test Duration	Units Failed/Tested
1	Moisture Sensitivity Level	J-STD-020E	$T_{\text{slid}} = 260^{\circ}\text{C}$ , 10sec, Precondition: $85^{\circ}\text{C}$ , 60%RH, 168hr		3 reflows	0/22
2	Low Temperature Storage	JESD22-A119	$T_{\text{a}} = -40^{\circ}\text{C}$		1000 hours	0/22
3	High Temperature Storage	JESD22-A103D	$T_{\text{a}} = 125^{\circ}\text{C}$		1000 hours	0/22
4	Low Temperature Operating Life	JESD22-A108D	$T_{\text{a}} = -40^{\circ}\text{C}$	1200mA	1000 hours	0/22
5	Temperature Humidity Operating Life	JESD22-A101C	$T_{\text{sp}} = 85^{\circ}\text{C}$ , RH=85%	1200mA	1000 hours	0/22
6	High Temperature Operating Life	JESD22-A108D	$T_{\text{sp}} = 85^{\circ}\text{C}$	1200mA	1000 hours	0/22
7	Thermal Shock	JESD22-A106B	$T_{\text{a}} = -40^{\circ}\text{C} \sim 125^{\circ}\text{C}$ ; Dwell : 15min; Transfer: 10sec		200 Cycle	0/22
8	Temperature Cycle	JESD22-A104E	$T_{\text{a}} = -40^{\circ}\text{C} \sim 125^{\circ}\text{C}$ ; Dwell at extreme temperature: 15min; Ramp rate < $105^{\circ}\text{C}/\text{min}$		200 Cycle	0/22
9	Electrostatic Discharge	JS-001-2012	HBM, 2kV, 15k $\Omega$ , 100pF, Alternately positive or negative			0/22
10	Vibration Test	JESD22-B103	10m/s <sup>2</sup> , 100-20000-100Hz 4 cycles,4min,eachX,Y,Z		4 Cycles	0/22

## Passing Criteria

Item	Symbol	Test Condition	Passing Criteria
Forward Voltage	Vf	1200mA	$\Delta V_f < 10\%$
Luminous Flux	Iv	1200mA	$\Delta I_v < 30\%$
Chromaticity Coordinates	(x, y)	1200mA	$\Delta u'v' < 0.007$

Notes for Table 9:

1. Test board: Aluminum board thickness -1.0mm, Copper layer thickness-70um.
2. Measurements are performed after allowing the LEDs to return to room temperature
3.  $T_{\text{slid}}$ : reflow soldering temperature;  $T_{\text{a}}$ : ambient temperature

# Reflowing Characteristics

Figure 12 : Reflow Profile

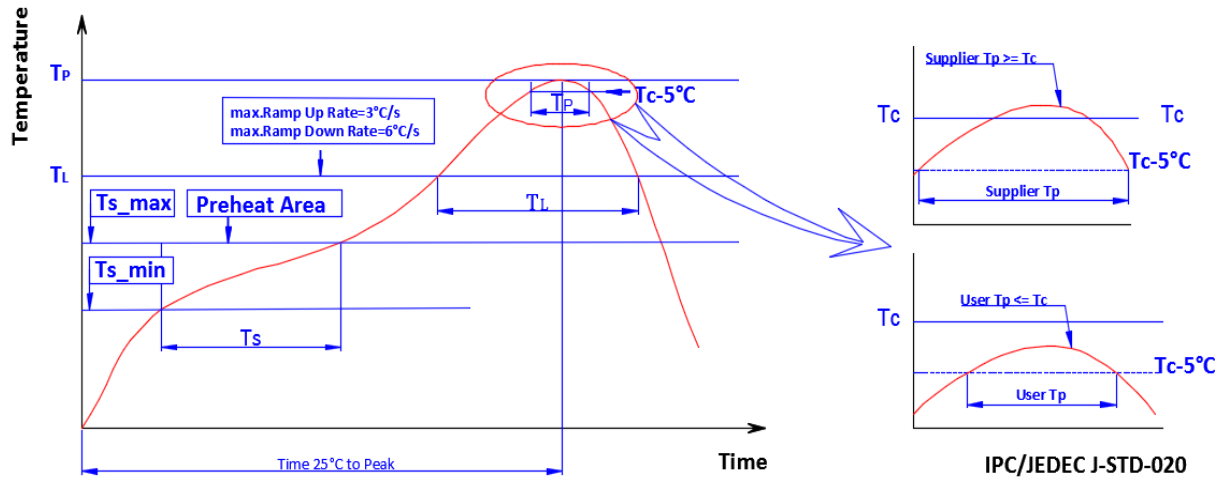

Profile Parameters	Lead-Free Solder SAC305
Average Ramp-Up Rate ( $T_{s_{\text{max}}}$ to $T_p$ )	3°C/second max.
Preheat: Temperature Min ( $T_{s_{\text{min}}}$ )	150°C
Preheat: Temperature Max ( $T_{s_{\text{max}}}$ )	190°C
Preheat: Time ( $t_{s_{\text{min}}}$ to $t_{s_{\text{max}}}$ )	90-120 seconds
Liquidous Temperature ( $T_l$ )	217°C
Time Maintained Above Liquidous Temperature ( $T_L$ ): Time ( $t_l$ )	60-90 seconds
Peak/Classification Temperature ( $T_p$ )	250-255°C
Time Within 10°C of Actual Peak Temperature ( $T_p$ )	20-40 seconds
Ramp-Down Rate	6°C/second max
Time 25°C to Peak Temperature	8 minutes max.



# Packaging

**Figure 13: Reel Drawings**

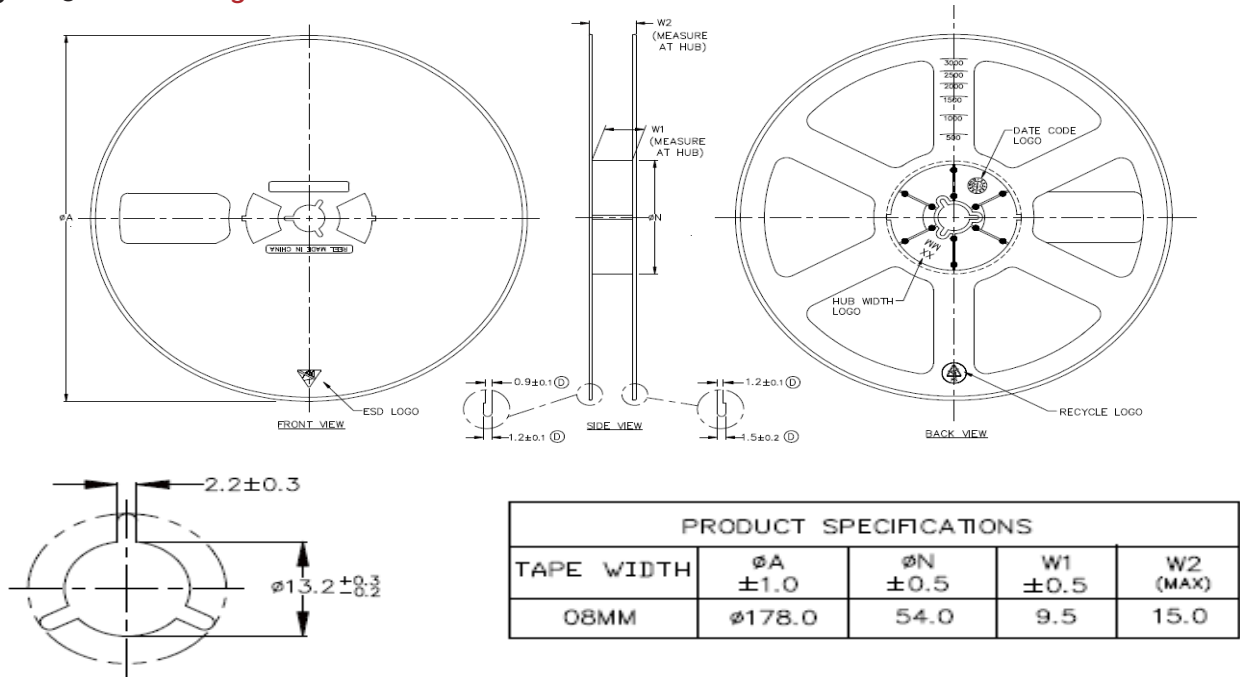

Note for Figure 13:

1. Drawings are not to scale. Drawing dimensions are in millimeters.

**Figure 14: Tape Drawings**

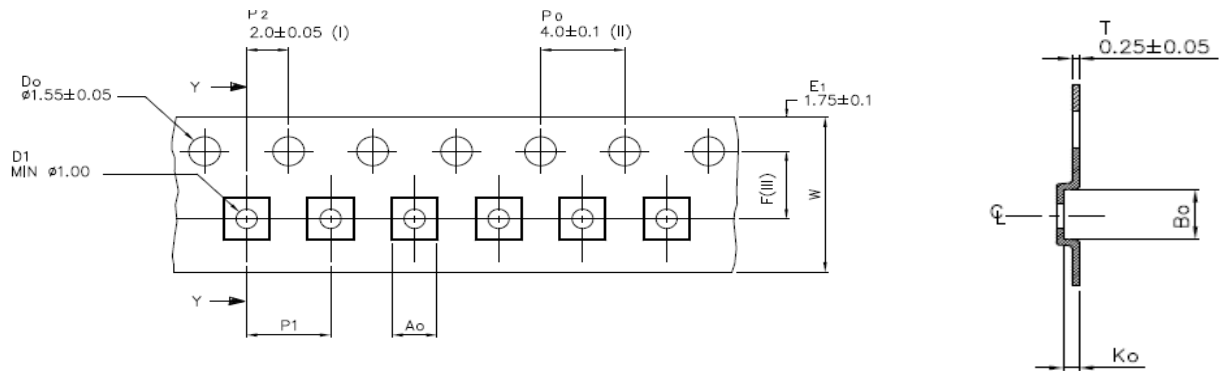

$A_0$	$B_0$	$K_0$	$F$	$P_1$	$W$
$2.20 \pm 0.05$	$2.2 \pm 0.05$	$0.55 \pm 0.05$	$3.5 \pm 0.05$	$4.00 \pm 0.10$	$8.00 + 0.3 - 0.1$

Note for Figure 14:

1. Drawings are not to scale. Drawing dimensions are in millimeters.

# Packaging

Figure 15: Reel Packaging Drawings

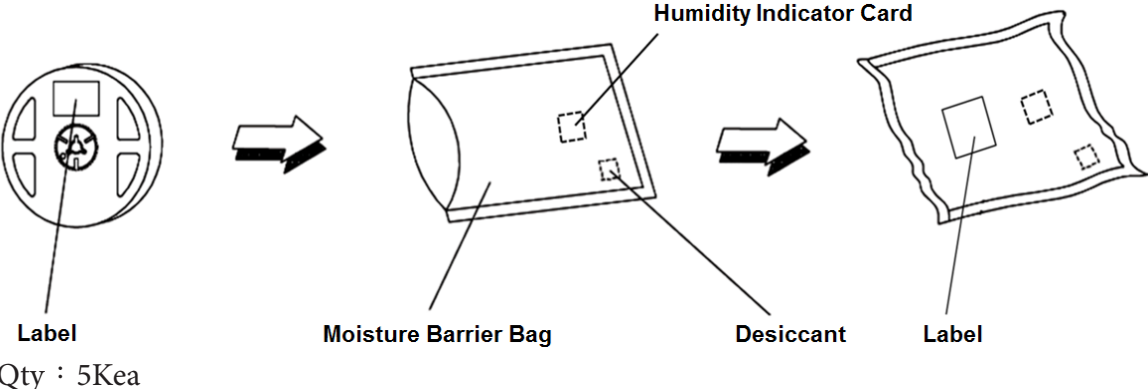

Note for Figure 15:  
1. Drawings are not to scale.

# Design Resources

## Optical Source Models

Please contact your Bridgelux sales representative for assistance.

## Precautions

### CAUTION: CHEMICAL EXPOSURE HAZARD

Exposure to some chemicals commonly used in luminaire manufacturing and assembly can cause damage to the CSP.

### CAUTION: EYE SAFETY

Eye safety classification for the use of Bridgelux CSP is in accordance with IEC specification 62471: Photobiological Safety of Lamps and Lamp Systems.

Most of Bridgelux CSPs are classified as Risk Group Exempt or Risk Group 1 in accordance with IEC specification 62471. However, the CSP LEDs will be classified as Risk Group 2 when operated at high power conditions with high ratio blue wavelength in the emission spectrum depending on characteristics. Please use appropriate precautions. It is important that employees working with LEDs are trained to use them safely.

### CAUTION: RISK OF BURN

Do not touch the CSP LES during operation. Allow the CSP to cool for a sufficient period of time before handling. The CSP may reach elevated temperatures such that could burn skin when touched.

## Disclaimers

### MINOR PRODUCT CHANGE POLICY

The rigorous qualification testing on products offered by Bridgelux provides performance assurance. Slight cosmetic changes that do not affect form, fit, or function may occur as Bridgelux continues product optimization.

### CAUTION: PICK AND PLACE

Recommend using Teflon material for nozzle. Sharp steel material must not be used as pick up tools.

## CAUTION

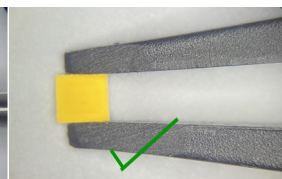
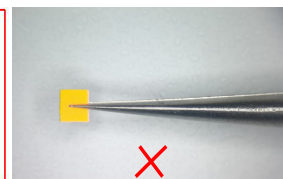
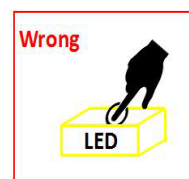

### STANDARD TEST CONDITIONS

Unless otherwise stated, LED emitter testing is performed at the nominal drive current.

# About Bridgelux: Bridging Light and Life™

At Bridgelux, we help companies, industries and people experience the power and possibility of light. Since 2002, we've designed LED solutions that are high performing, energy efficient, cost effective and easy to integrate. Our focus is on light's impact on human behavior, delivering products that create better environments, experiences and returns—both experiential and financial. And our patented technology drives new platforms for commercial and industrial luminaires.

**For more information about the company, please visit**  
**bridgelux.com**  
**twitter.com/Bridgelux**  
**facebook.com/Bridgelux**  
**WeChat ID: BridgeluxInChina**



**46410 Fremont Boulevard**  
**Fremont, CA 94538 U.S.A.**  
**Tel (925) 583-8400**  
**www.bridgelux.com**

© 2023 Bridgelux, Inc. All rights reserved. Product specifications are subject to change without notice. Bridgelux and the Bridgelux stylized logo design are registered trademarks of Bridgelux, Inc. All other trademarks are the property of their respective owners.

Bridgelux CSP 1919 Product Data Sheet DS954 Rev. C (06/2023)